

SPECIFICATION FOR APPROVAL

REF :

PAGE: 1

PROD. NAME	SMD POWER INDUCTOR	ABC'S DWG NO.	SB1608□□□□2□-□□□
		ABC'S ITEM NO.	

. CONFIGURATION & DIMENSIONS :

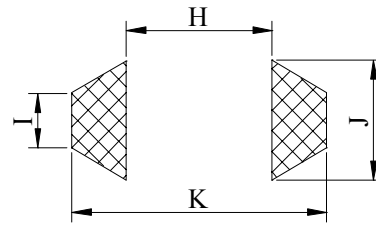
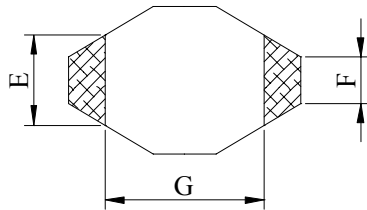
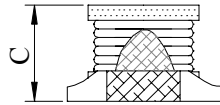
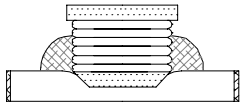
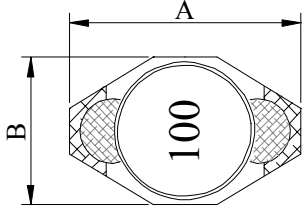

(PCB Pattern)

- A : 6.60 max. m/m
- B : 4.45 max. m/m
- C : 2.92 max. m/m
- E : 3.05 typ. m/m
- F : 1.27 typ. m/m
- G : 4.32 typ. m/m
- H : 4.10 (ref) m/m
- I : 1.60 (ref) m/m
- J : 3.00 (ref) m/m
- K : 7.00 (ref) m/m

. SCHEMATIC DIAGRAM :

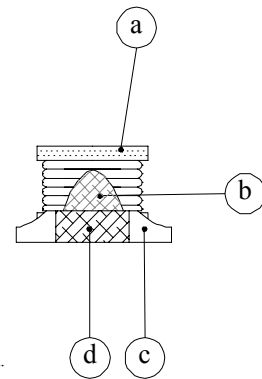
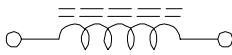

. MATERIALS :

- a . Core : Ferrite DR core
- b . Wire : Enamelled copper wire (class F)
- c . Base : Ceramic
- d . Terminal : MoMn/Ni/Au
- e . Adhesive : Epoxy resin
- f . Remark : Products comply with RoHS' requirements

Peak Temp : 260 max.
 Max time above 230 : 50sec max.
 Max time above 200 : 70sec max.

. GENERAL SPECIFICATION :

- a . Temp. rise : 15 typ.
- b . Storage temp. : -40 ----+125
- c . Operating temp. : -40 ----+105
- d . DC Current base on temp. rise & $\Delta L/L0A=10\%$ typ.
- e . Resistance to solder heat : 260 .10 secs.

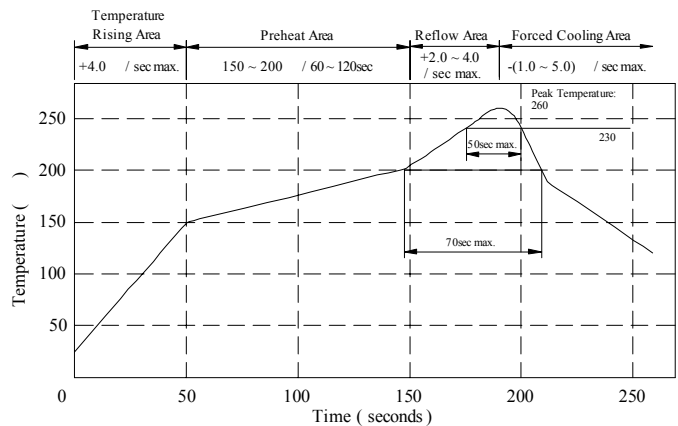

AE-001A

SPECIFICATION FOR APPROVAL

REF :

PAGE: 2

PROD. NAME	SMD POWER INDUCTOR	ABC'S DWG NO.	SB1608□□□□2□-□□□
		ABC'S ITEM NO.	

. ELECTRICAL CHARACTERISTICS :

DWG No.	Inductance (μ H) $\pm 20\%$	SRF (MHz) typ.	RDC (Ω) max.	I _{rms} (A)	I _{sat} (A)
SB16081R0M2□-□□□	1.0	130	0.05	2.90	2.90
SB16081R5M2□-□□□	1.5	115	0.05	2.80	2.60
SB16082R2M2□-□□□	2.2	90	0.07	2.40	2.30
SB16083R3M2□-□□□	3.3	70	0.08	2.00	2.00
SB16084R7M2□-□□□	4.7	50	0.09	1.50	1.50
SB16086R8M2□-□□□	6.8	45	0.13	1.40	1.20
SB1608100M2□-□□□	10.0	35	0.16	1.10	1.10
SB1608150M2□-□□□	15.0	30	0.23	1.00	0.90
SB1608220M2□-□□□	22.0	20	0.37	0.80	0.70
SB1608330M2□-□□□	33.0	15	0.51	0.60	0.58
SB1608470M2□-□□□	47.0	14	0.64	0.50	0.50
SB1608680M2□-□□□	68.0	11	0.86	0.40	0.40
SB1608101M2□-□□□	100.0	9	1.27	0.30	0.31
SB1608151M2□-□□□	150.0	6	2.00	0.25	0.27
SB1608221M2□-□□□	220.0	5.5	3.11	0.20	0.22
SB1608331M2□-□□□	330.0	5	3.80	0.16	0.18
SB1608471M2□-□□□	470.0	4	5.06	0.15	0.16
SB1608681M2□-□□□	680.0	3	9.20	0.12	0.14
SB1608102M2□-□□□	1000.0	2	13.80	0.07	0.10

1). □ : Packaging Information... Bulk Taping Reel

2). "- □□□": Reference code

3). Inductance Tested at 0.1V/100KHz

4). Inductance drop=10% typ. at rated I_{sat}.

5). t=15 rise typ. at I_{rms}.

6). Electrical Specifications at 25 .

@ Inductance VS. DC Current Curve

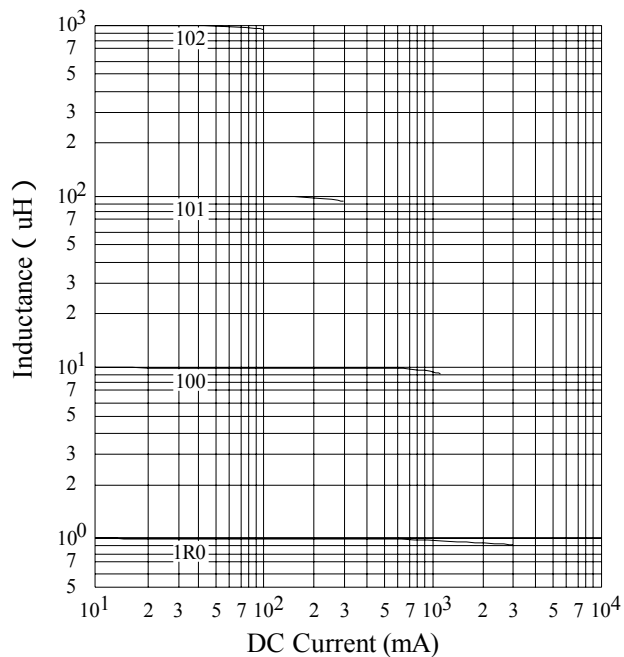

AE-001A

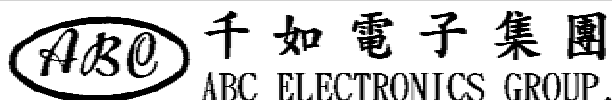

SPECIFICATION FOR APPROVAL

REF :

PAGE: 3

PROD. NAME	SMD POWER INDUCTOR	ABC'S DWG NO.	SB1608□□□□2□-□□□
		ABC'S ITEM NO.	

. PACKAGING INFORMATION :

(1) Configuration

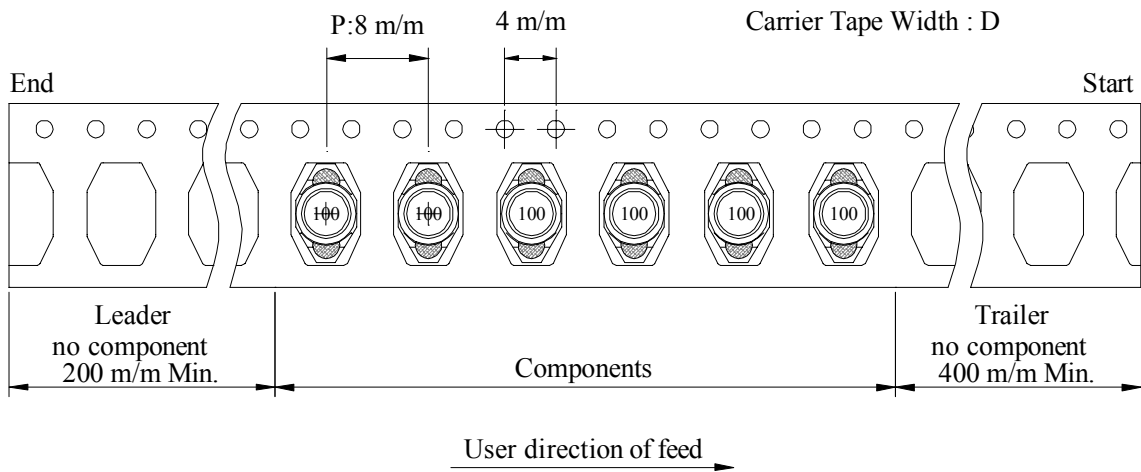
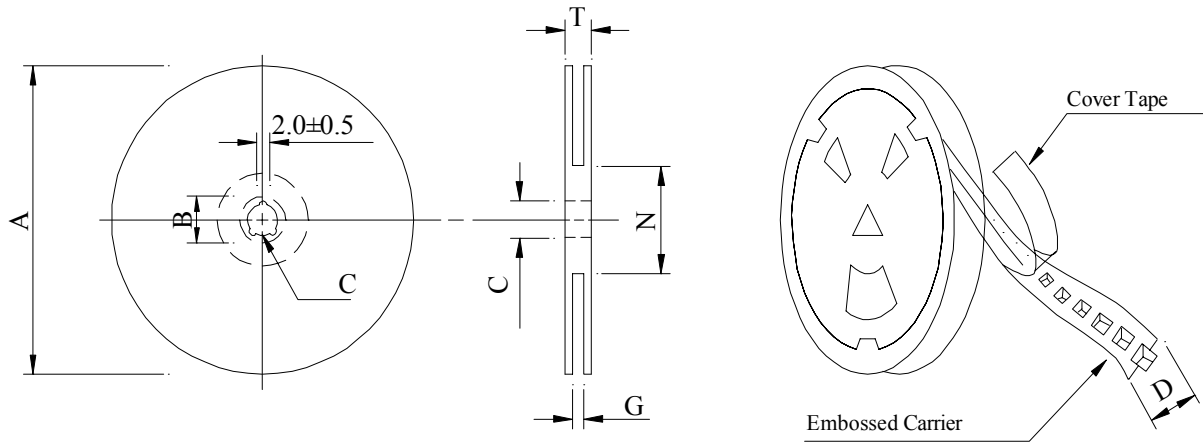

(2) Dimensions

Unit:m/m

Style	A	B	C	D	G	N	T
07-12	178	21±0.8	13	12	14 ⁺⁰	50 ⁻⁰	16.5
13-12	330	21±0.8	13±0.5	12	14 ⁺⁰	50 ⁻⁰	18.4

(3) Q'TY & G.W. Per Package

Series	Inner : Reel			Outer : Carton		
	Q'TY (pcs)	G.W. (gw)	Style	Q'TY (pcs)	G.W. (Kg)	Size (cm)
SB1608	600	215	07-12	24,000	9.4	42 x 41 x 24
SB1608	2,500	900	13-12	20,000	8.0	40 x 40 x 24

AE-001A

SPECIFICATION FOR APPROVAL

REF :

PAGE: 4

PROD. NAME	SMD POWER INDUCTOR	ABC'S DWG NO.	SB1608□□□□2□-□□□
		ABC'S ITEM NO.	

. DWGING NUMBER EXPRESSION :

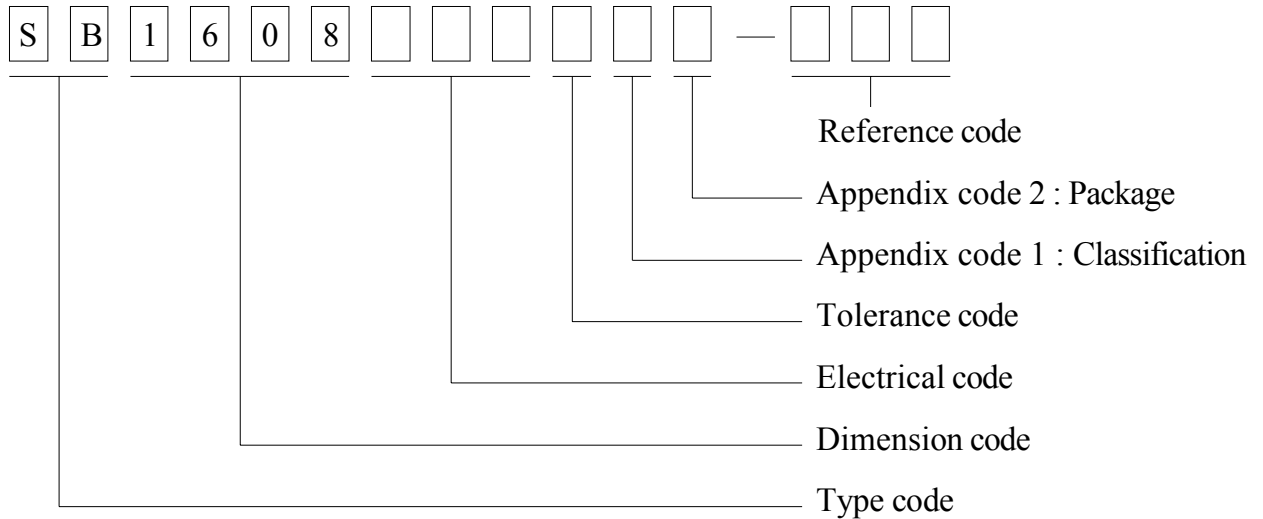

Appendix code 1 : Product Classification

- L : Lead Free Standard products comply with RoHS' requirements
- 1 ~ 9 : Lead Free Special products comply with RoHS' requirements

Appendix code 2 : Package Information

Code	Inner package	Inner package Q'TY	Remark
A	T.B.D.	T.B.D.	
B	T / R (Reel package)	600 pcs	
C	T / R (Reel package)	2500 pcs	

SPECIFICATION FOR APPROVAL

REF :

PAGE: 5

PROD. NAME	SMD POWER INDUCTOR	ABC'S DWG NO.	SB1608□□□□2□-□□□
		ABC'S ITEM NO.	

. RELIABILITY TEST :

Test item	Specification	Test condition						
Solderability	More than 90% of the terminal electrode shall be covered With fresh solder.	Preheat : 150±25 for 60 seconds Solder : Sn96.5 / Ag3 / Cu0.5 or equivalent Solder temp. : 235±5 Flux : Rosin Dip time : 4±1 seconds						
Thermal shock test (Temp. cycle)	Inductance shall not change more than ±20%	<table style="width: 100%; border: none;"> <tr> <td style="text-align: center;">Room temp. 15 minutes</td> <td style="text-align: center; vertical-align: middle;">→</td> <td style="text-align: center;">-25±2 30 minutes</td> </tr> <tr> <td style="text-align: center;">Room temp. 15 minutes</td> <td style="text-align: center; vertical-align: middle;">→</td> <td style="text-align: center;">85±2 30 minutes</td> </tr> </table> <p>Total : 50 cycles</p>	Room temp. 15 minutes	→	-25±2 30 minutes	Room temp. 15 minutes	→	85±2 30 minutes
Room temp. 15 minutes	→	-25±2 30 minutes						
Room temp. 15 minutes	→	85±2 30 minutes						
Humidity Resistance test		Temperature : 40±2 Humidity : 90 ~ 95% Applied current : Per spec. Time : 500 hours						
High temp. Resistance test		Temperature : 105±2 Applied current : Per spec. Time : 500 hours						

AE-001A

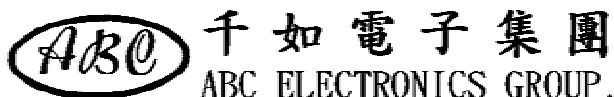

SPECIFICATION FOR APPROVAL

REF :

PAGE: 6

PROD. NAME	SMD POWER INDUCTOR	ABC'S DWG NO.	SB1608□□□□2□-□□□
		ABC'S ITEM NO.	

UL CARD :

OBMW2 September 8, 2000
Magnet Wire-Component

JUNG SHING WIRE CO LTD E174837
231 CHUNG CHENG RD, SEC 3 JEN-TEH HSIANG, TAINAN
HSIEN TAIWAN

Mtl Dsg	Mark Dsg	BC	Coat Typ	OC	ANSI Type	Temp Class
AIW	---	Polyamideimide		---	MW81-C	220
CFUEWB	---	Polyurethane		---	MW75C	130
EIAIW	---	Polyesterimide		Polyamideimide	MW35C	200
EILOCKY	---	Polyesterimide		Polyamide	---	180
EILOCKW	---	Polyesterimide		Modified Epoxy	---	200
EIW	---	Polyesterimide		---	---	220
EIW-2	---	Polyesterimide		---	MW74-C	200
FL.EILOCKY	---	Modified Polyester		Polyamide	---	155
LSFFW	---	Polyurethane		---	MW79-C	155
LSUEW	---	Polyurethane		---	---	130
PEW	---	Polyester		---	---	155
PEY	---	Polyester		Nylon	MW24-C	155
SF.FLW	---	Modified Polyester		---	MW26C	155
SF.EIW	---	Polyesterimide		---	MW77C	180
SF.BY@	---	Modified Polyester		Nylon	MW27-C	155
SF.FLY@	---	Modified Polyester		Nylon	MW27-C	155
SF.BLOCKBS	---	Modified Polyester		Modified Polyamide	---	155
SF.EILOCKY#	---	Polyesterimide		Polyamide	---	180
SF.EILOCKBS	---	Polyesterimide		Modified Polyamide	---	180
SF.BW@	---	Modified Polyester		---	MW26C	155
SFFW	---	Polyurethane		---	MW79	155

A not-for-profit organization dedicated to public safety and committed to quality service

287806002 Page 1 of 2

Mtl Dsg	Mark Dsg	BC	Coat Typ	OC	ANSI Type	Temp Class
SFFY	---	Polyurethane		Polyamide	MW80C	155
UEW-1	---	Polyurethane		---	MW2-C	105
UEW-2	---	Polyurethane		---	---	130
UEW-4	---	Polyurethane		---	MW75C	130
UEY	---	Polyurethane		Nylon	MW28-C	130
UEY-2	---	Polyurethane		Polyamide	MW28-C	130

@-May be suffixed by LZ; # - May be suffixed by LZ, EL or LZI.
LZ - Signifies magnd wires twisted together; EL - signifies base coated magnet wire laid parallel with top coat applied overall; LZL - signifies base coated magnet wire twisted together and covered with top coat overall.

Marking: Company name or trademarks or 榮星電線, material designation or marked designation on packaed or reel, and Recognized Component Mark.

See General Information Preceding These Recognitions
For use only in equipment where the acceptability of the combination is determined by Underwriters Laboratories Inc.

287806002 Page 2 of 2 OBMW2E174837
September 8, 2000

AE-001A

