

SI-3000KM Series Surface Mount, Low Current Consumption, Low Dropout Voltage Linear Regulator ICs

■ Features

- Compact surface mount package (TO252-5)
- Output current: 1.0 A
- Low dropout voltage: $V_{DIF} \leq 0.6 V$ (at $I_o = 1.0 A$)
- Low current consumption: $I_q \leq 350 \mu A$ (600 μA for SI-3010KM/SI-3050KM/SI-3090KM/SI-3120KM)
- Low circuit current at output OFF: $I_q (OFF) \leq 1 \mu A$
- Built-in overcurrent and thermal protection circuits
- Output ON/OFF control function
- Compatible with low ESR capacitors (SI-3012KM/SI-3025KM/SI-3033KM)

■ Absolute Maximum Ratings

($T_a=25^\circ C$)

Parameter	Symbol	Ratings		Unit
		SI-3012KM/ 3025KM/3033KM	SI-3010KM/3050KM/ 3090KM/3120KM	
DC Input Voltage	V_{IN}	17	35 ^{*1}	V
Output Control Terminal Voltage	V_c	V_{IN}		V
DC Output Current	I_o	1.0		A
Power Dissipation	P_D^{*2}	1		W
Junction Temperature	T_j	-30 to +125		$^\circ C$
Storage Temperature	T_{stg}	-30 to +125		$^\circ C$
Thermal Resistance (Junction to Ambient Air)	θ_{j-a}^{*2}	95		$^\circ C/W$
Thermal Resistance (Junction to case)	θ_{j-c}	6		$^\circ C/W$

*1: A built-in input-overvoltage-protection circuit shuts down the output voltage at the Input Overvoltage Shutdown Voltage of the electrical characteristics.

*2: When mounted on glass-epoxy board of 900mm² (copper laminate area 4.3%).

■ Applications

- Secondary stabilized power supply (local power supply)

■ Recommended Operating Conditions

Parameter	Symbol	Ratings						Unit	
		SI-3012KM	SI-3025KM	SI-3033KM	SI-3010KM	SI-3050KM	SI-3090KM		SI-3120KM
Input Voltage Range	V_{IN}	2.4 ^{*2} to 6.0 ^{*1}	2.4 ^{*2} to 5 ^{*1}	^{*2} to 6 ^{*1}	2.4 ^{*2} to 27 ^{*1}	2.4 ^{*2} to 17 ^{*1}	^{*2} to 20 ^{*1}	^{*2} to 25 ^{*1}	V
Output Current Range	I_o	0 to 1.0						A	
Operating Ambient Temperature	T_{op}	-30 to +85						$^\circ C$	
Operating Junction Temperature	T_j	-20 to +100						$^\circ C$	

*1: V_{IN} (max) and I_o (max) are restricted according to operating conditions due to the relation $P_D = (V_{IN}-V_o) \times I_o$. Please calculate these values referring to the Copper Laminate Area vs. Power Dissipation data as shown hereinafter.

*2: Refer to the Dropout Voltage parameter.

■ Electrical Characteristics 1 (Low V_o type compatible with low ESR output capacitor)

Parameter	Symbol	Ratings									Unit
		SI-3012KM (Variable type)			SI-3025KM			SI-3033KM			
		min.	typ.	max.	min.	typ.	max.	min.	typ.	max.	
Input Voltage	V_{IN}	2.4 ^{*1}			^{*1}			^{*1}			V
Output Voltage (Reference voltage VADJ for SI-3012KM)	$V_o (V_{ADJ})$	1.24	1.28	1.32	2.45	2.50	2.55	3.234	3.300	3.366	V
	Conditions	$V_{IN}=3.3V, I_o=10mA$			$V_{IN}=3.3V, I_o=10mA$			$V_{IN}=5V, I_o=10mA$			
Line Regulation	ΔV_{OLINE}			15			15			15	mV
	Conditions	$V_{IN}=3.3$ to 8V, $I_o=10mA$ ($V_o=2.5V$)			$V_{IN}=3.3$ to 8V, $I_o=10mA$			$V_{IN}=5$ to 10V, $I_o=10mA$			
Load Regulation	ΔV_{OLOAD}			40			40			50	mV
	Conditions	$V_{IN}=3.3V, I_o=0$ to 1A ($V_o=2.5V$)			$V_{IN}=3.3V, I_o=0$ to 1A			$V_{IN}=5V, I_o=0$ to 1A			
Dropout Voltage	V_{DIF}			0.4			0.4			0.4	V
	Conditions	$I_o=0.5A$ ($V_o=2.5V$)			$I_o=0.5A$			$I_o=0.5A$			
				0.6			0.6			0.6	
	Conditions	$I_o=1A$ ($V_o=2.5V$)			$I_o=1A$			$I_o=1A$			
Quiescent Circuit Current	I_q			350			350			350	μA
	Conditions	$V_{IN}=3.3V, I_o=0A, V_c=2V, R_2=24k\Omega$			$V_{IN}=3.3V, I_o=0A, V_c=2V$			$V_{IN}=5V, I_o=0A, V_c=2V$			
Circuit Current at Output OFF	$I_q (OFF)$			1			1			1	μA
	Conditions	$V_{IN}=3.3V, V_c=0V$			$V_{IN}=3.3V, V_c=0V$			$V_{IN}=5V, V_c=0V$			
Temperature Coefficient of Output Voltage	$\Delta V_o/\Delta T_a$			± 0.3			± 0.3			± 0.3	mV/ $^\circ C$
	Conditions	$T_j=0$ to 100 $^\circ C$ ($V_c=2.5V$)			$T_j=0$ to 100 $^\circ C$			$T_j=0$ to 100 $^\circ C$			
Ripple Rejection	R_{REJ}			55			55			55	dB
	Conditions	$V_{IN}=3.3V, f=100$ to 120Hz ($V_o=2.5V$)			$V_{IN}=3.3V, f=100$ to 120Hz			$V_{IN}=5V, f=100$ to 120Hz			
Overcurrent Protection Starting Current ^{*2}	I_{S1}	1.1			1.1			1.1			A
	Conditions	$V_{IN}=3.3V$			$V_{IN}=3.3V$			$V_{IN}=5V$			
Vc Terminal	Control Voltage (Output ON)	V_c, I_H	2.0			2.0			2.0		V
	Control Voltage (Output OFF)	V_c, I_L			0.8		0.8			0.8	
	Control Current (Output ON)	I_c, I_H			40		40			40	μA
	Conditions	$V_c=2V$			$V_c=2V$			$V_c=2V$			
	Control Current (Output OFF)	I_c, I_L	-5	0		-5	0		-5	0	μA
	Conditions	$V_c=0V$			$V_c=0V$			$V_c=0V$			

*1: Refer to the Dropout Voltage parameter.

*2: I_{S1} is specified at the 5% drop point of output voltage V_o on the condition that V_{IN} =overcurrent protection starting current, $I_o = 10 mA$.

*3: Output is OFF when output control terminal (Vc terminal) is open. Each input level is equivalent to LS-TTL level. Therefore, the device can be driven directly by LS-TTLs.

■Electrical Characteristics 2 (High Vo type)

Parameter	Symbol	Ratings												Unit
		SI-3010KM (Variable type)			SI-3050KM			SI-3090KM			SI-3120KM			
		min.	typ.	max.	min.	typ.	max.	min.	typ.	max.	min.	typ.	max.	
Input Voltage	V _{IN}	2.4 ^{*1}			*1			*1			*1			V
Output Voltage (Reference voltage V _{ADJ} for SI-3010KM)	V _O (V _{ADJ})	0.98	1.00	1.02	4.90	5.00	5.10	8.82	9.00	9.18	11.76	12.00	12.24	V
	Conditions	V _{IN} =7V, I _O =10mA			V _{IN} =7V, I _O =10mA			V _{IN} =11V, I _O =10mA			V _{IN} =14V, I _O =10mA			
Line Regulation	ΔV _{OLINE}			30			30			54			72	mV
	Conditions	V _{IN} =6 to 11V, I _O =10mA (V _O =5V)			V _{IN} =6 to 11V, I _O =10mA			V _{IN} =10 to 15V, I _O =10mA			V _{IN} =13 to 18V, I _O =10mA			
Load Regulation	ΔV _{OLOAD}			75			75			135			180	mV
	Conditions	V _{IN} =7V, I _O =0 to 1A (V _O =5V)			V _{IN} =7V, I _O =0 to 1A			V _{IN} =11V, I _O =0 to 1A			V _{IN} =14V, I _O =0 to 1A			
Dropout Voltage	V _{DIF}			0.3			0.3			0.3			0.3	V
	Conditions	I _O =0.5A (V _O =5V)			I _O =0.5A			I _O =0.5A			I _O =0.5A			
	Conditions	I _O =1A (V _O =5V)			I _O =1A			I _O =1A			I _O =1A			
Quiescent Circuit Current	I _q			600			600			600			600	μA
	Conditions	V _{IN} =7V, I _O =0A, V _C =2V, R ₂ =10kΩ			V _{IN} =7V, I _O =0A, V _C =2V			V _{IN} =11V, I _O =0A, V _C =2V			V _{IN} =14V, I _O =0A, V _C =2V			
Circuit Current at Output OFF	I _q (OFF)			1			1			1			1	μA
	Conditions	V _{IN} =7V, V _C =0V			V _{IN} =7V, V _C =0V			V _{IN} =11V, V _C =0V			V _{IN} =14V, V _C =0V			
Temperature Coefficient of Output Voltage	ΔV _O /ΔT _a			±0.5			±0.5			±1.0			±1.5	mV/°C
	Conditions	T _J =0 to 100°C (V _O =5V)			T _J =0 to 100°C			T _J =0 to 100°C			T _J =0 to 100°C			
Ripple Rejection	R _{REJ}			75			75			68			66	dB
	Conditions	V _{IN} =7V, f=100 to 120Hz (V _O =5V)			V _{IN} =7V, f=100 to 120Hz			V _{IN} =11V, f=100 to 120Hz			V _{IN} =14V, f=100 to 120Hz			
Overcurrent Protection Starting Current ^{*2}	I _{S1}	1.1			1.1			1.1			1.1			A
	Conditions	V _{IN} =7V			V _{IN} =7V			V _{IN} =11V			V _{IN} =14V			
V _C Terminal	Control Voltage (Output ON)	V _C , IH	2.0		2.0			2.0			2.0			V
	Control Voltage (Output OFF)	V _C , IL			0.8			0.8			0.8			V
	Control Current (Output ON)	I _C , IH			40			40			40			μA
	Control Current (Output OFF)	I _C , IL	-5	0		-5	0		-5	0		-5	0	μA
Input Overvoltage Shutdown Voltage	V _{OVP}	33			26			30			33			V
	Conditions	I _O =10mA			I _O =10mA			I _O =10mA			I _O =10mA			

*1: Refer to the Dropout Voltage parameter.

*2: I_{S1} is specified at the 5% drop point of output voltage V_O on the condition that V_{IN}=overcurrent protection starting current, I_O = 10 mA.

*3: Output is OFF when output control terminal (V_C terminal) is open. Each input level is equivalent to LS-TTL level. Therefore, the device can be driven directly by LS-TTLs.

*4: SI-3010KM, SI-3050KM and SI-3090KM, SI-3120KM cannot be used in the following applications because the built-in foldback-type overcurrent protection may cause errors during start-up stage.

(1) Constant current load (2) Positive and negative power supply (3) Series-connected power supply (4) V_O adjustment by raising ground voltage

*5: V_{IN} (max) and I_O (max) are restricted by the relation P_D = (V_{IN} - V_O) × I_O. Please calculate these values referring to the Copper Laminate Area vs. Power Dissipation data as shown hereinafter.

■External Dimensions (TO252-5)

(Unit : mm)

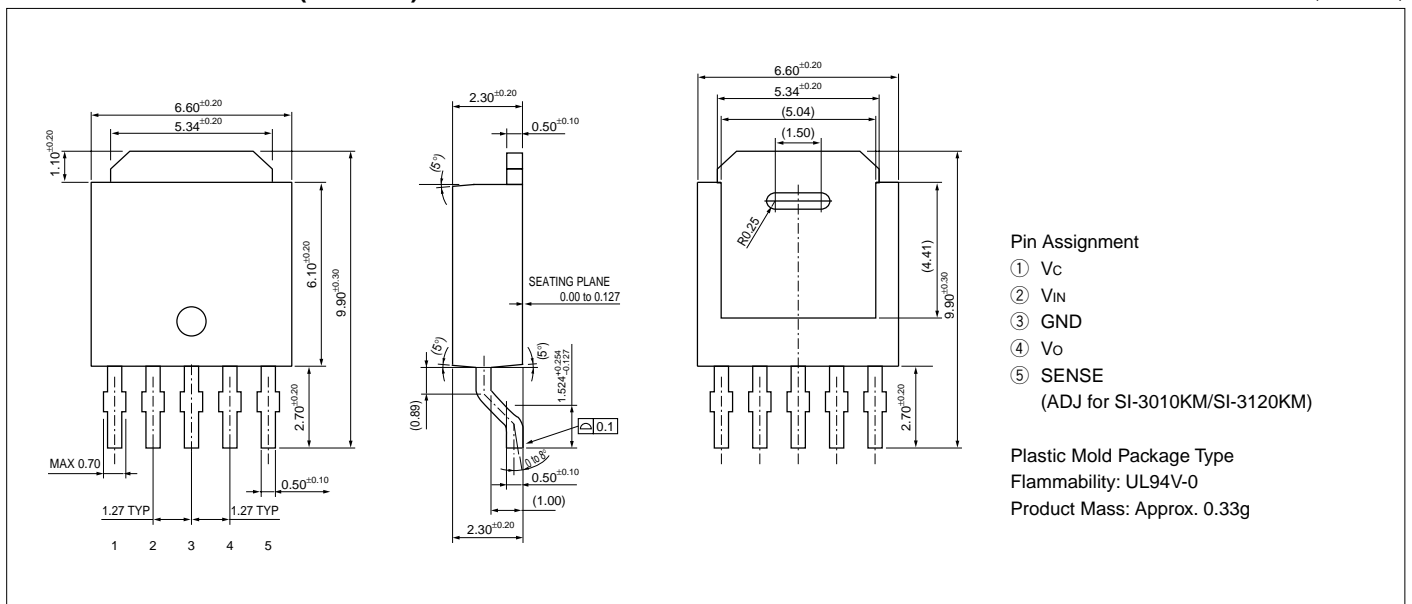

■Block Diagram

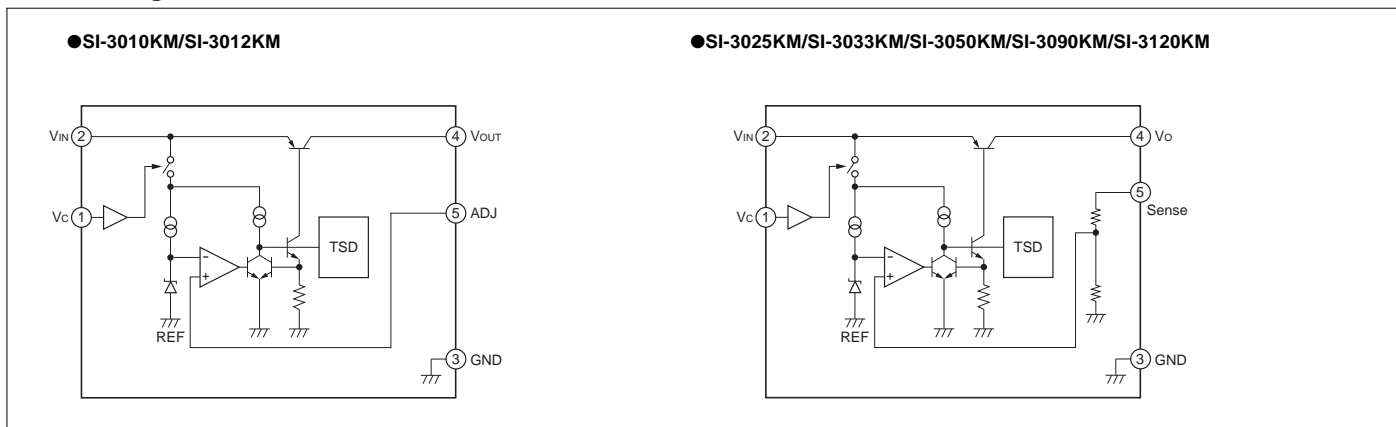

■Typical Connection Diagram

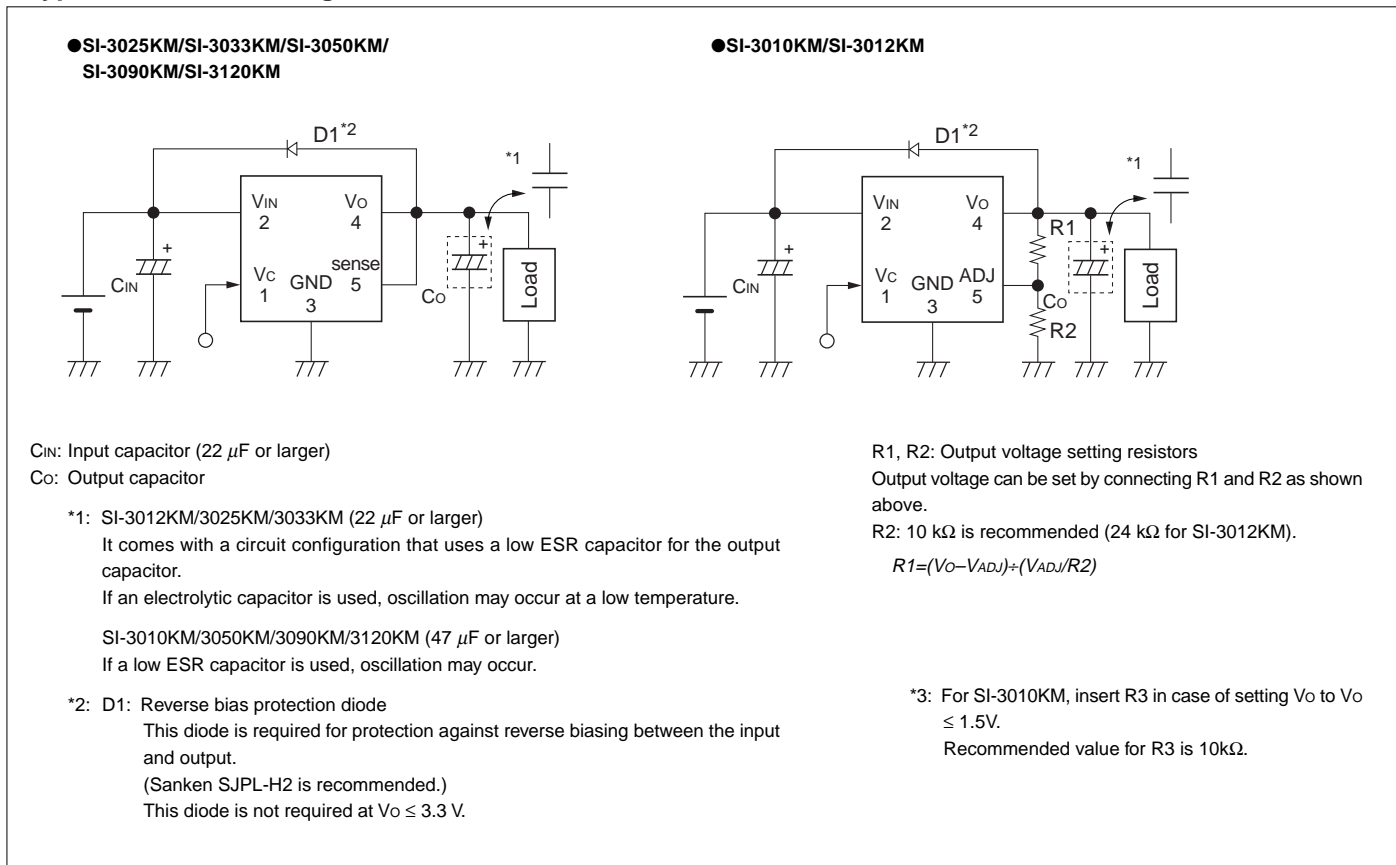

■Reference Data

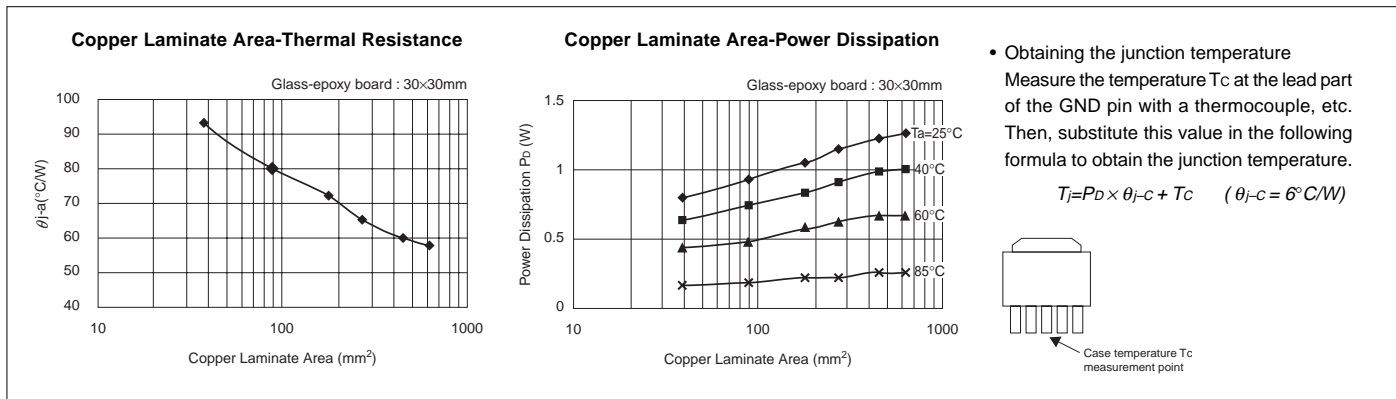

■Reference Data

Copper Foil Area-Thermal Resistance

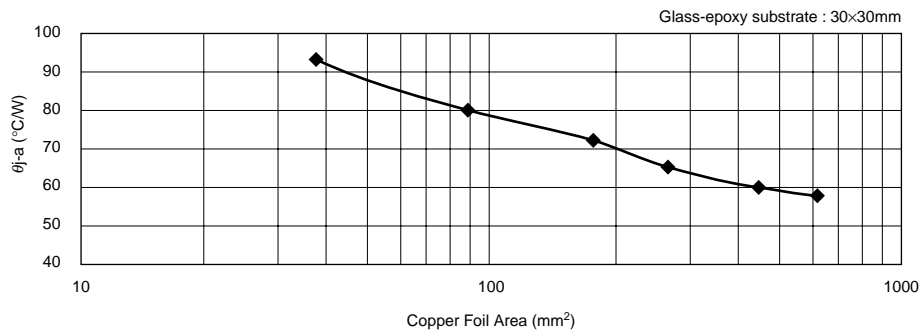

Copper Foil Area-Power Dissipation

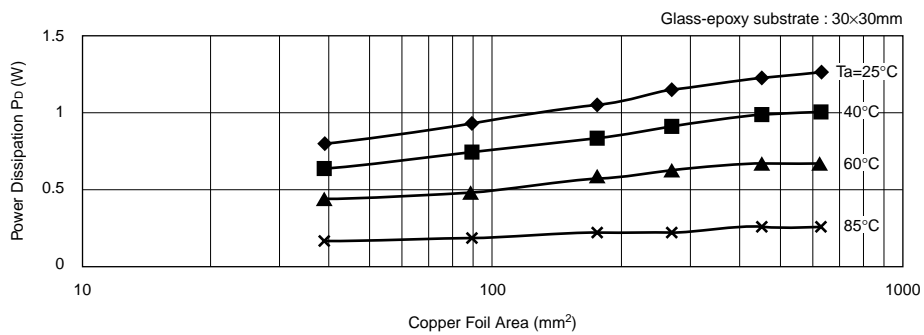

• Obtaining Junction Temperature

Temperature of lead part of GND terminal: Measure T_c with thermocouple. Substitute value to the following formula to obtain the junction temperature

$$T_j = P_D \times \theta_{j-c} + T_c \quad (\theta_{j-c} = 6^\circ\text{C/W})$$

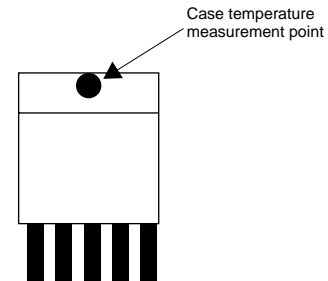

■Example of Soldering Pattern Design

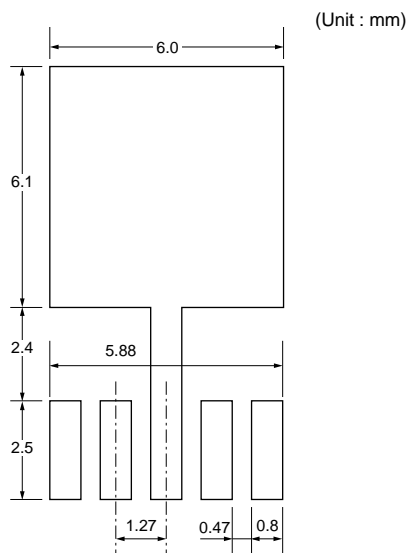

■Packing Specifications

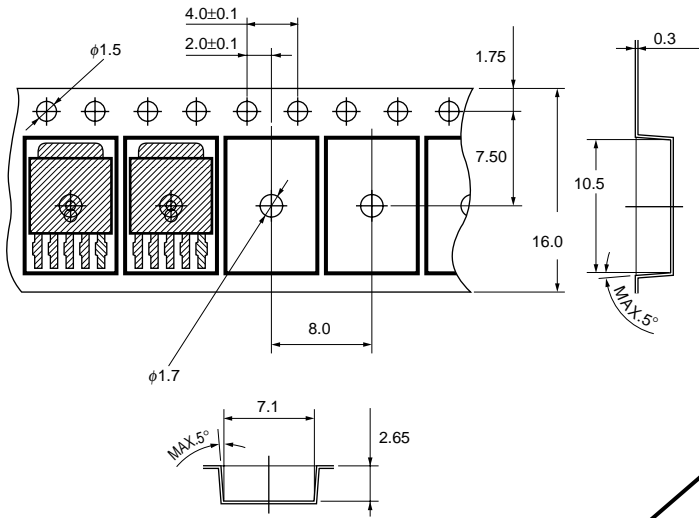

(Unit : mm)

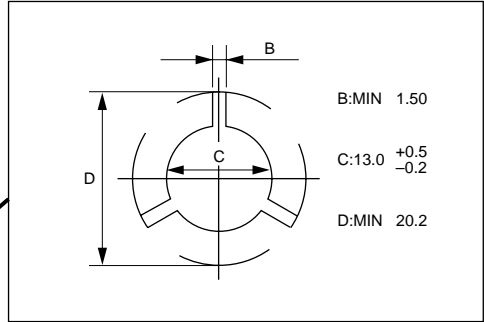

Reel : Packing quantity 3000 pcs

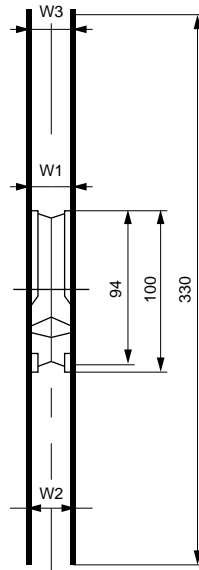
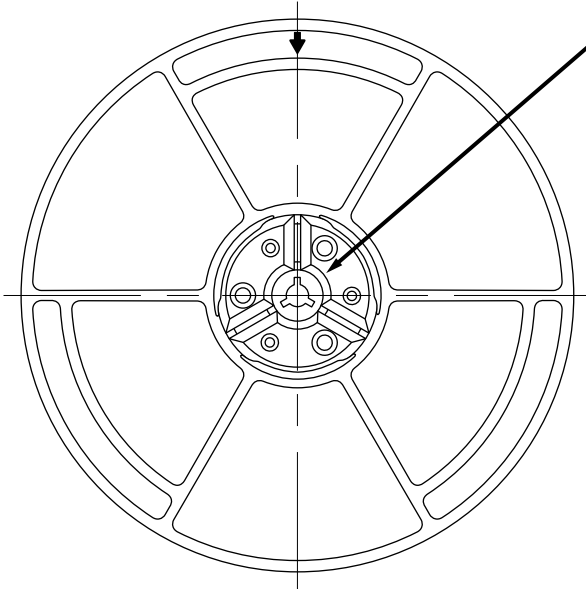

W1 $\begin{matrix} +2 \\ -0 \end{matrix}$	W2 MAX	W1 $\begin{matrix} +3 \\ -0.5 \end{matrix}$
16.4 mm	22.4 mm	16.4 mm

■SI-3012KM Typical Characteristics

($T_a=25^\circ\text{C}$) *At $V_{out}=2.5\text{V}$ measurement ($R_2=24\text{k}\Omega$)

Dropout Voltage

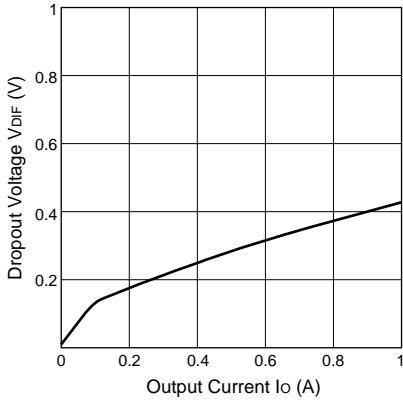

Output Rise Characteristics

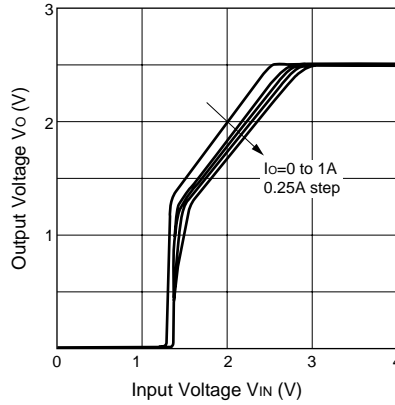

Line Regulation

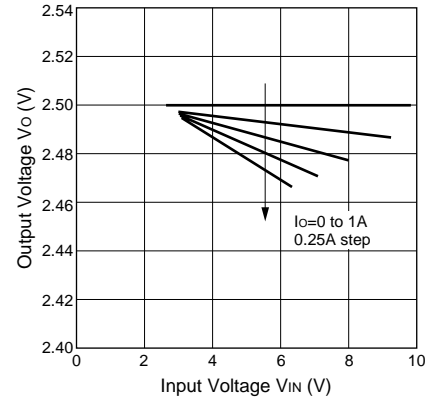

Load Regulation

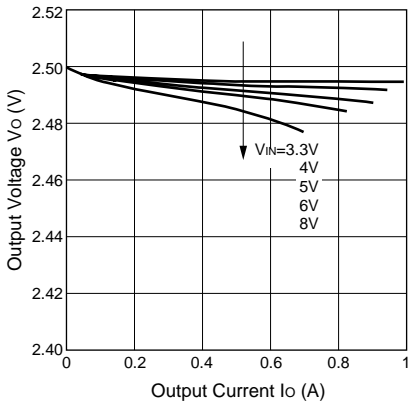

Overcurrent Protection Characteristics

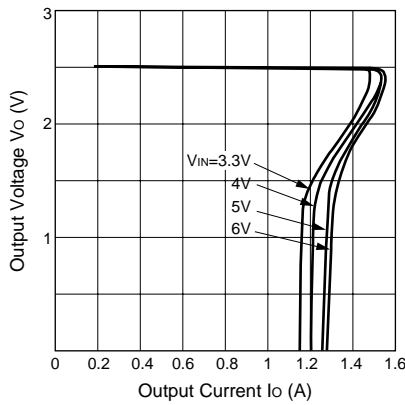

Quiescent Circuit Current

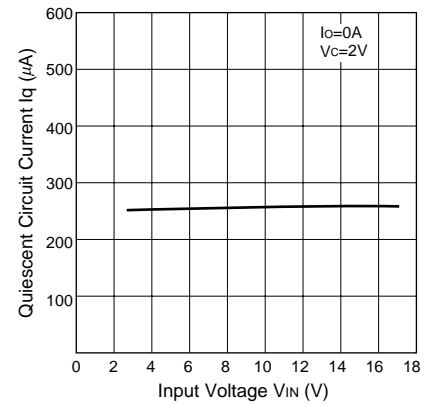

Circuit Current

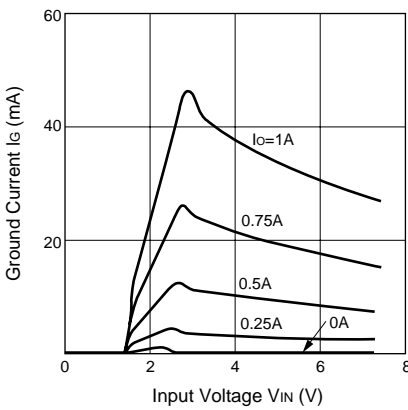

Output ON/OFF Control

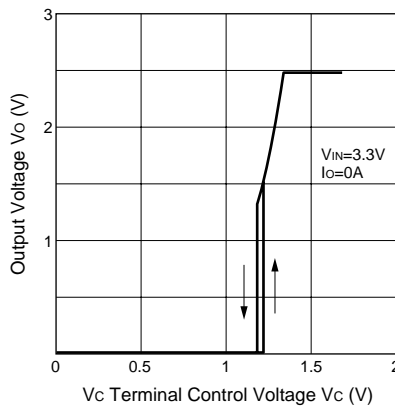

Output ON/OFF Control Current

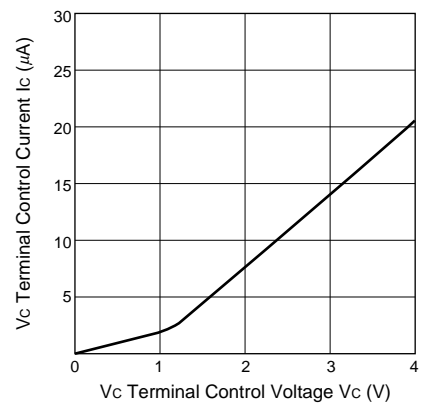

■SI-3025KM Typical Characteristics

($T_a=25^\circ\text{C}$)

Dropout Voltage

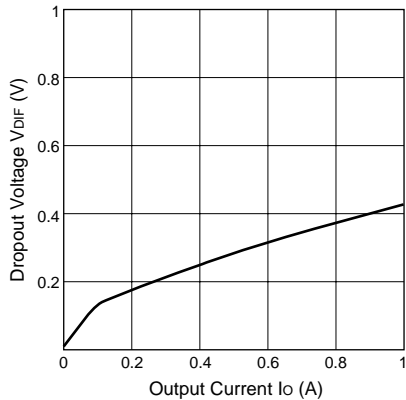

Output Rise Characteristics

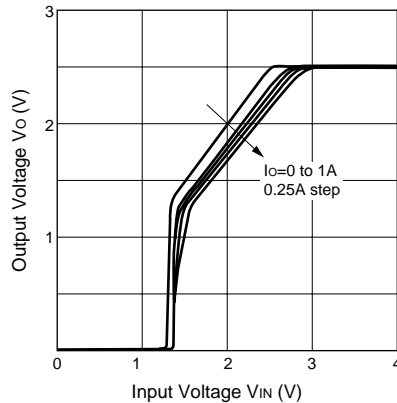

Line Regulation

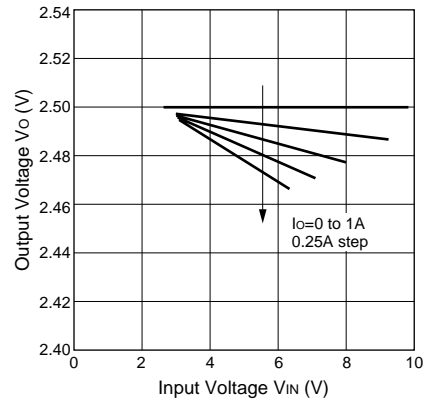

Load Regulation

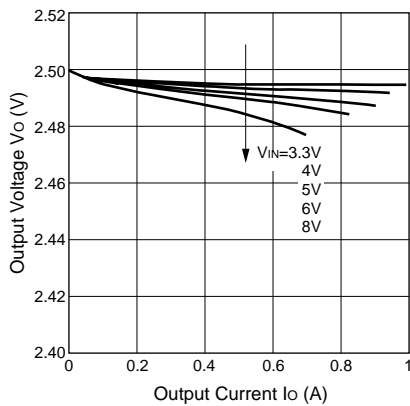

Overcurrent Protection Characteristics

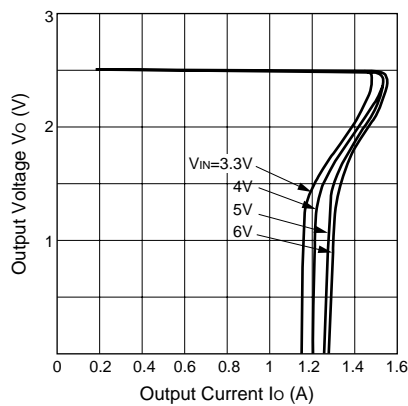

Quiescent Circuit Current

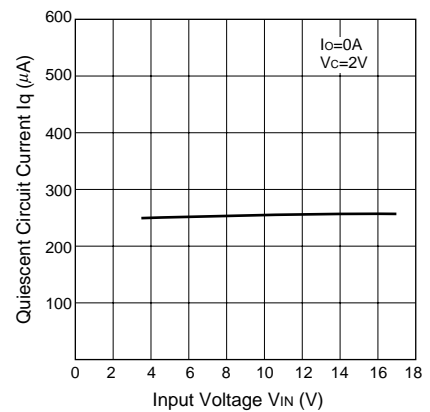

Circuit Current

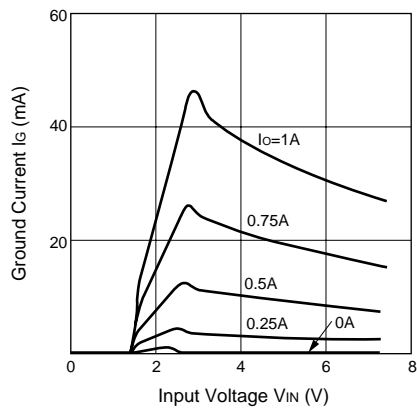

Output ON/OFF Control

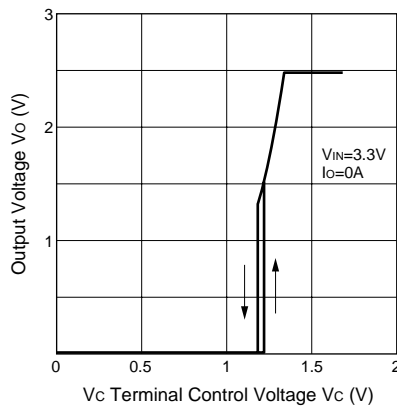

Output ON/OFF Control Current

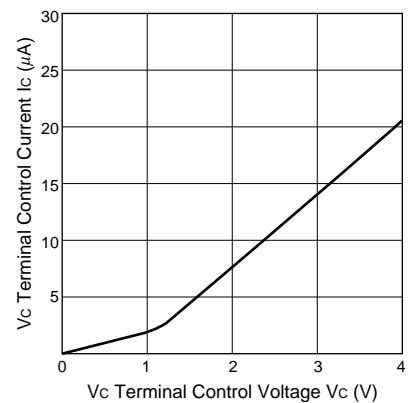

Thermal Protection Characteristics

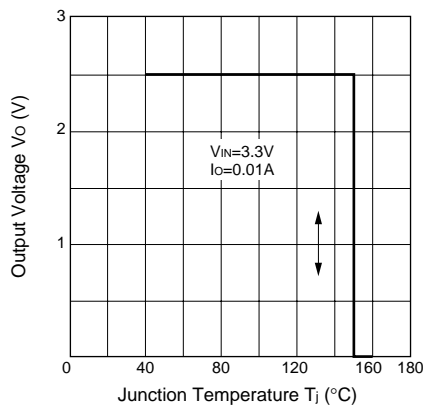

■SI-3033KM Typical Characteristics

($T_a=25^\circ\text{C}$)

Dropout Voltage

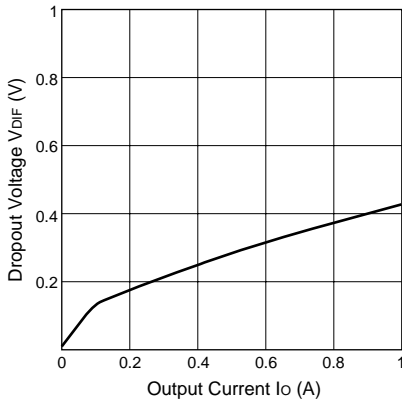

Output Rise Characteristics

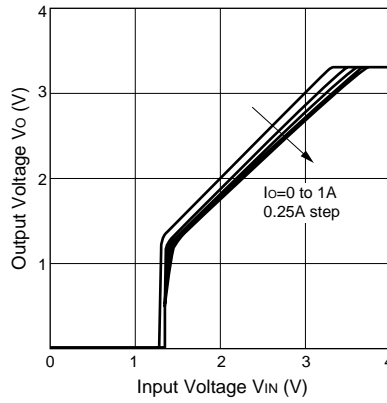

Line Regulation

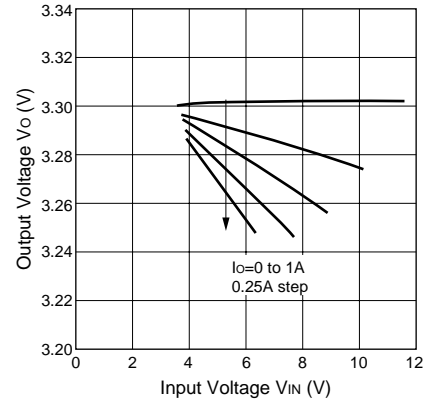

Load Regulation

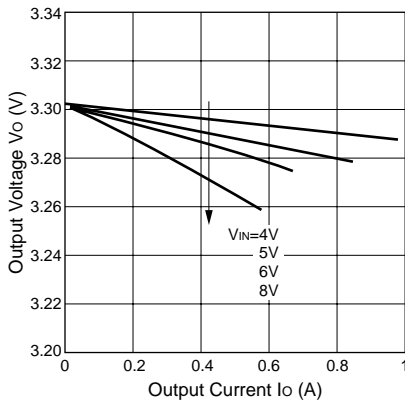

Overcurrent Protection Characteristics

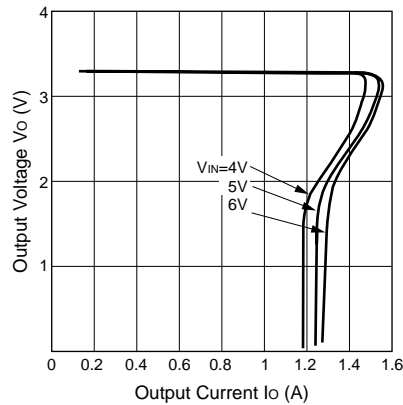

Quiescent Circuit Current

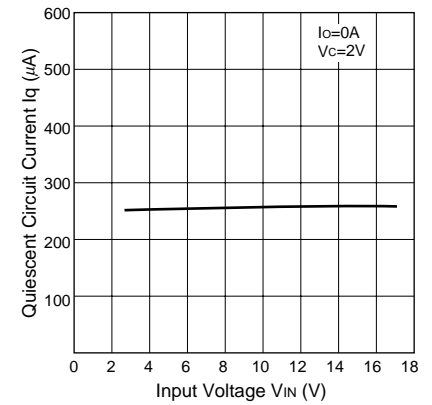

Circuit Current

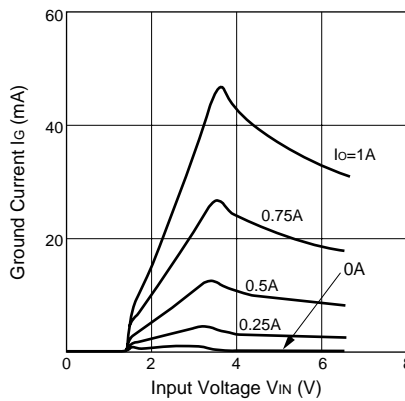

Output ON/OFF Control

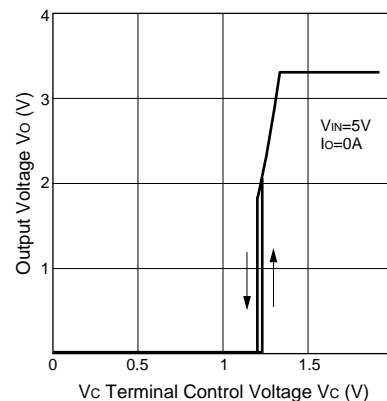

Output ON/OFF Control Current

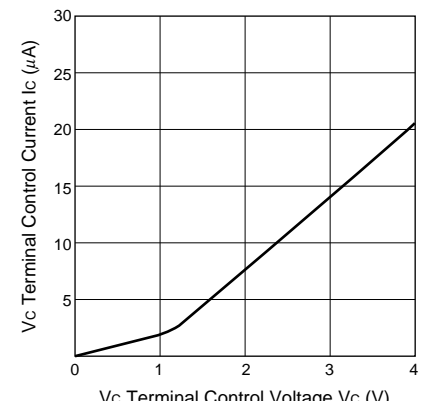

Thermal Protection Characteristics

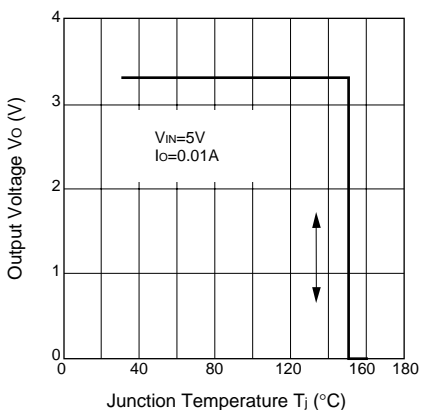

■SI-3010KM Typical Characteristics

($T_a=25^{\circ}\text{C}$) *At $V_{\text{out}}=2.5\text{V}$ measurement ($R_2=10\text{ k}\Omega$)

Dropout Voltage

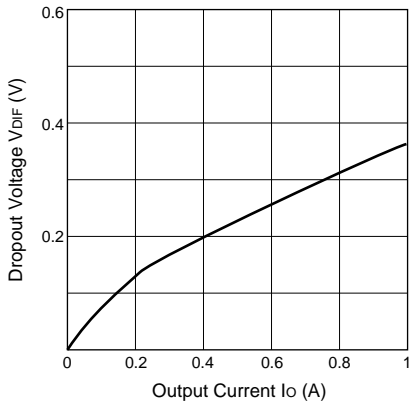

Output Rise Characteristics

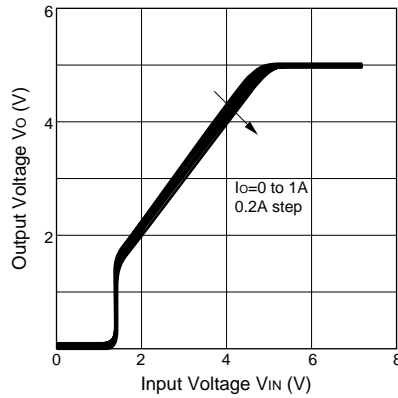

Line Regulation

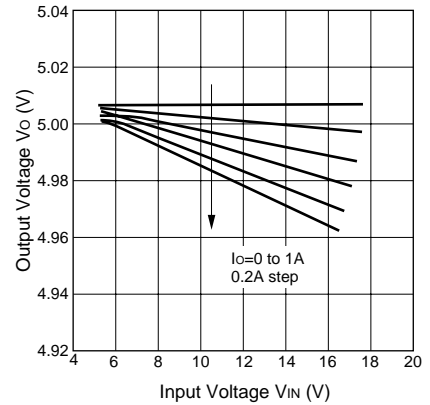

Load Regulation

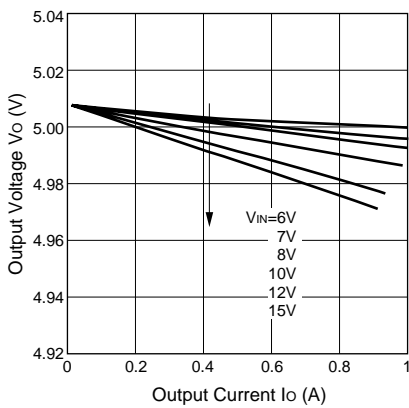

Overcurrent Protection Characteristics

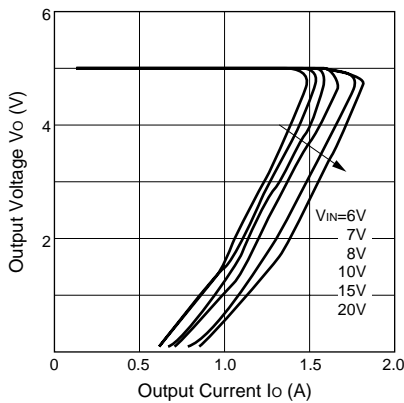

Quiescent Circuit Current

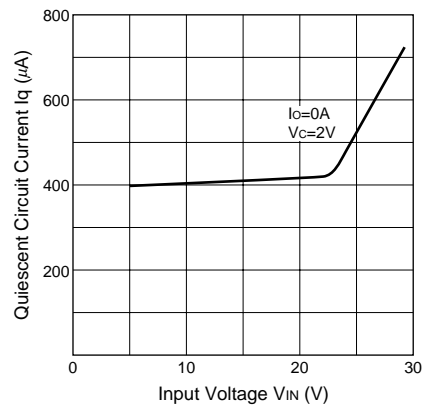

Circuit Current

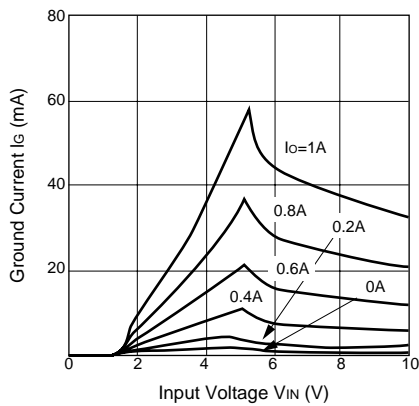

Output ON/OFF Control

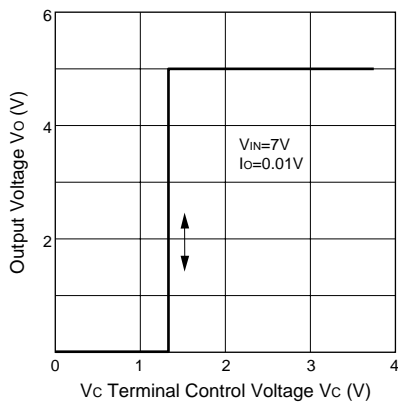

Output ON/OFF Control Current

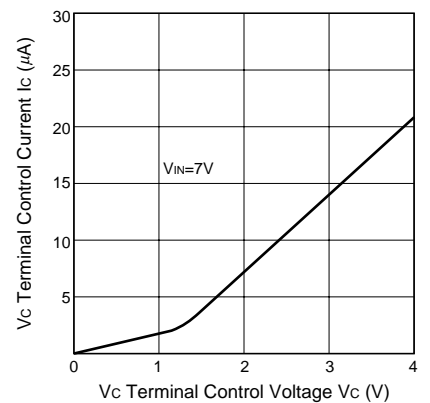

Thermal Protection Characteristics

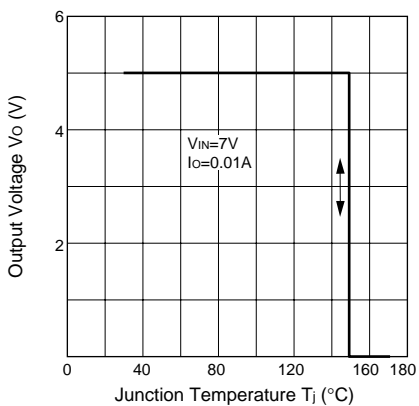

Overinput Voltage Protection Characteristics

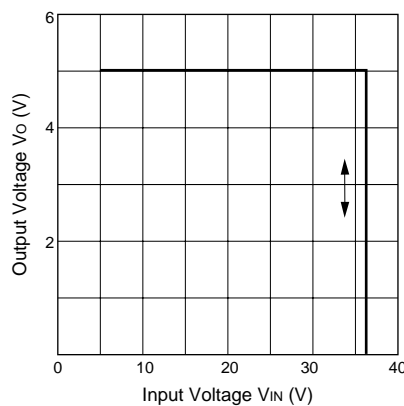

■SI-3050KM Typical Characteristics

($T_a=25^\circ\text{C}$)

Dropout Voltage

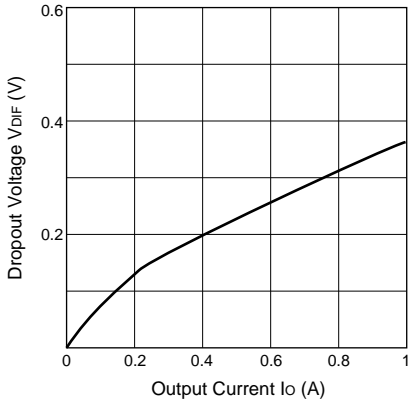

Output Rise Characteristics

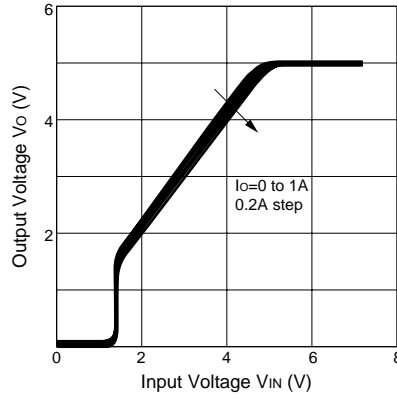

Line Regulation

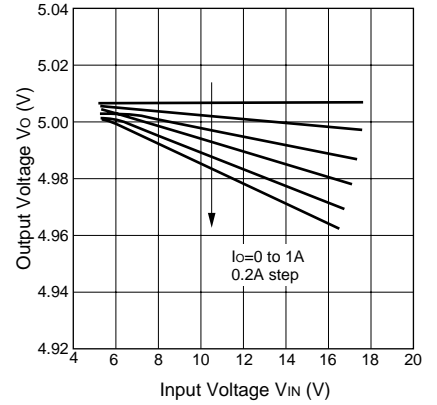

Load Regulation

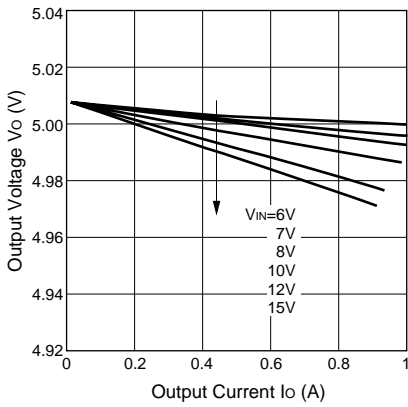

Overcurrent Protection Characteristics

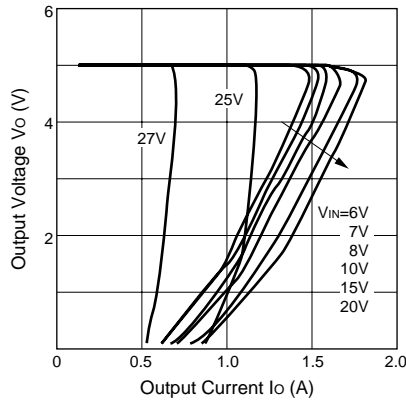

Quiescent Circuit Current

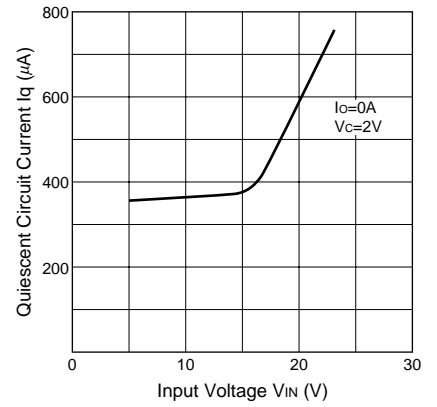

Circuit Current

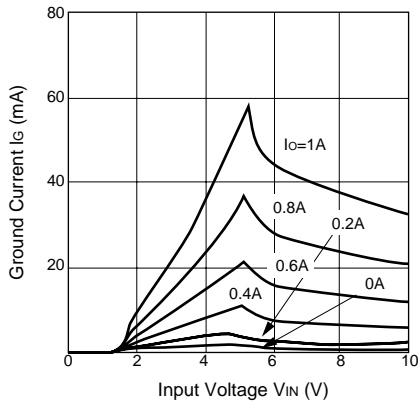

Output ON/OFF Control

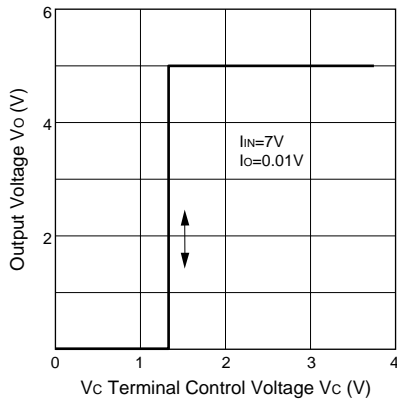

Output ON/OFF Control Current

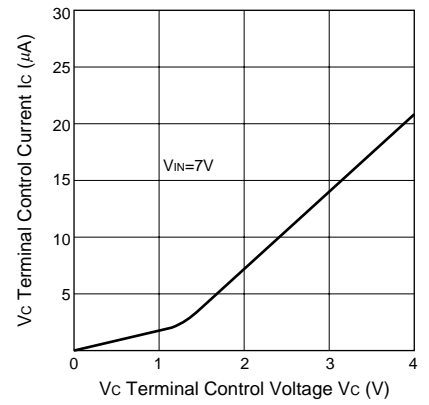

Thermal Protection Characteristics

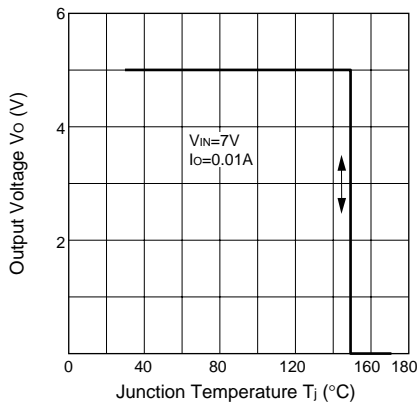

Overinput Voltage Protection Characteristics

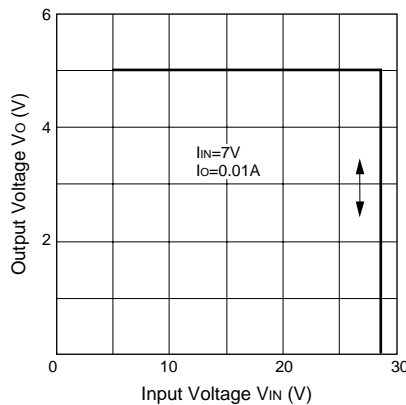

■SI-3090KM Typical Characteristics

($T_a=25^\circ\text{C}$)

Dropout Voltage

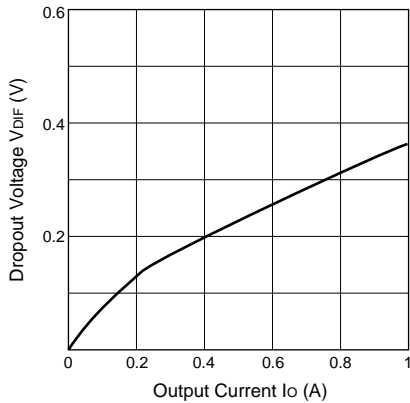

Output Rise Characteristics

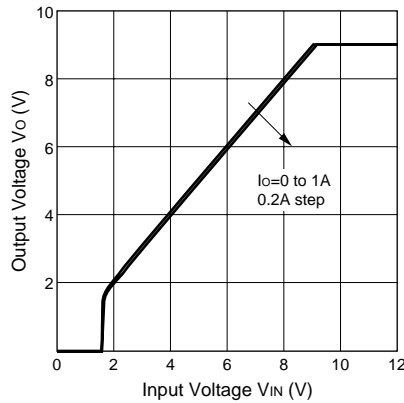

Line Regulation

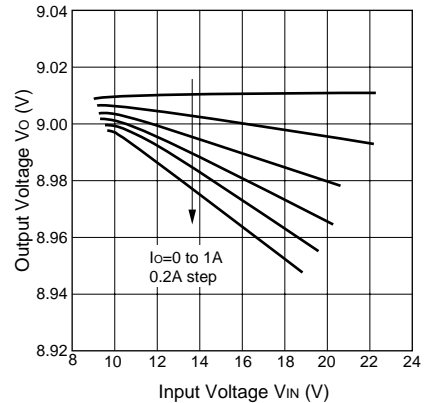

Load Regulation

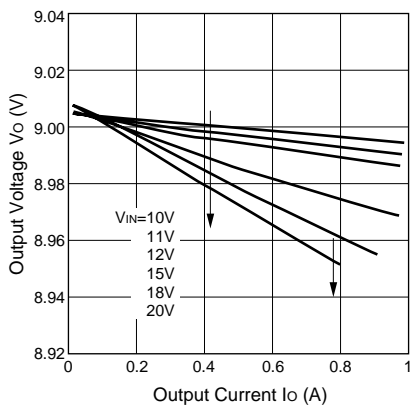

Overcurrent Protection Characteristics

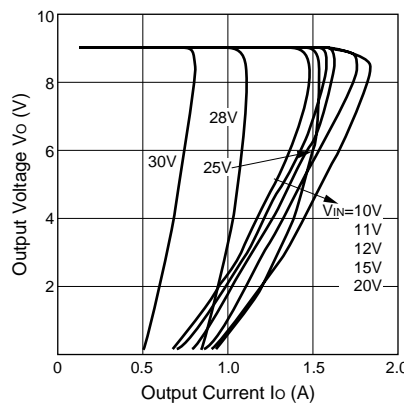

Quiescent Circuit Current

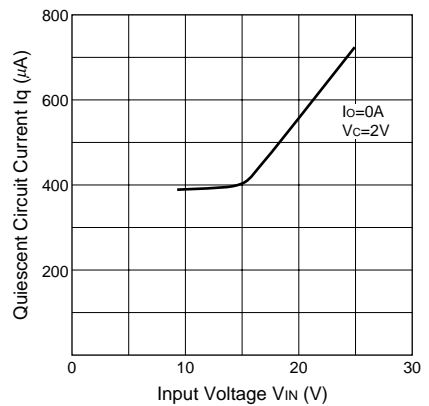

Circuit Current

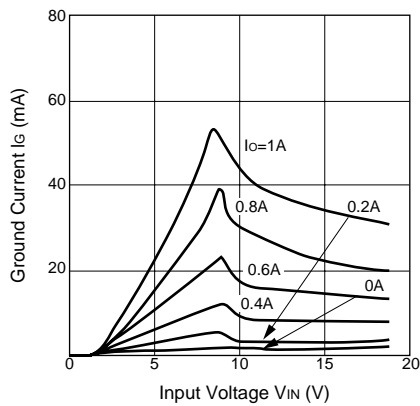

Output ON/OFF Control

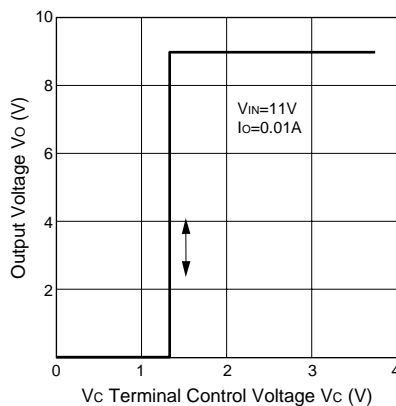

Output ON/OFF Control Current

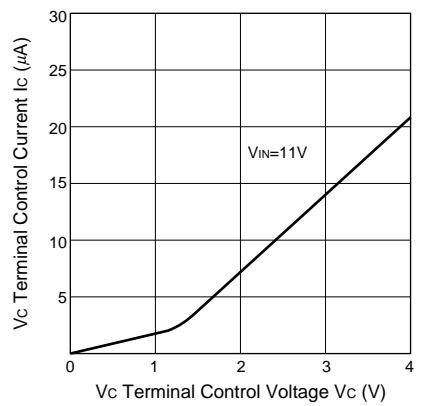

Thermal Protection Characteristics

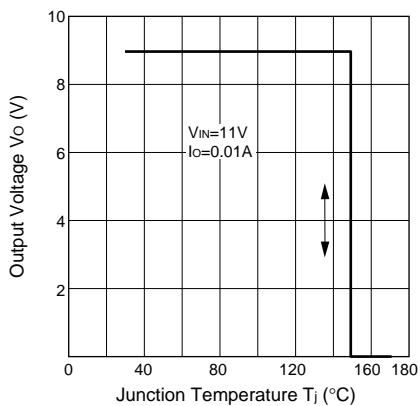

Overinput Voltage Protection Characteristics

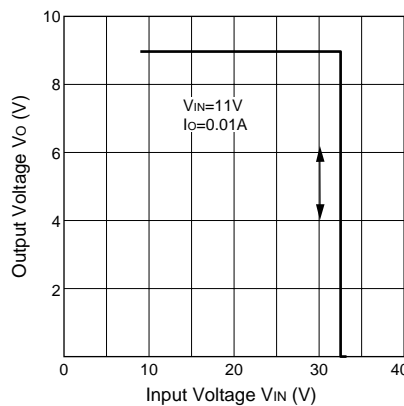

■SI-3120KM Typical Characteristics

($T_a=25^\circ\text{C}$)

Dropout Voltage

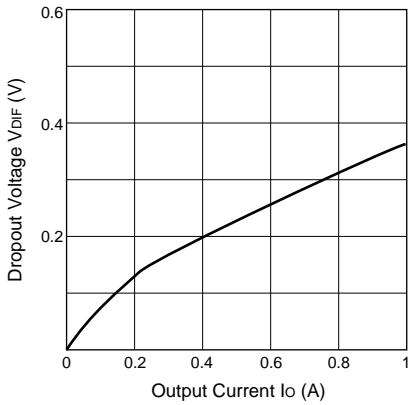

Output Rise Characteristics

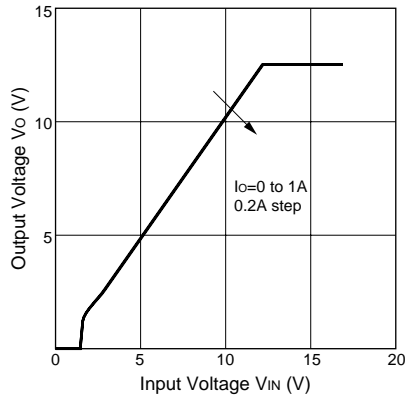

Line Regulation

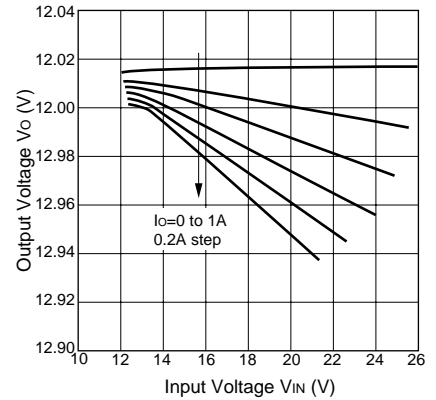

Load Regulation

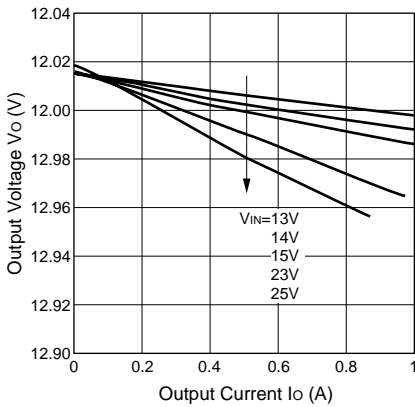

Overcurrent Protection Characteristics

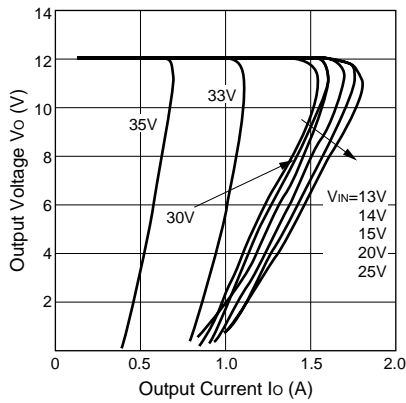

Quiescent Circuit Current

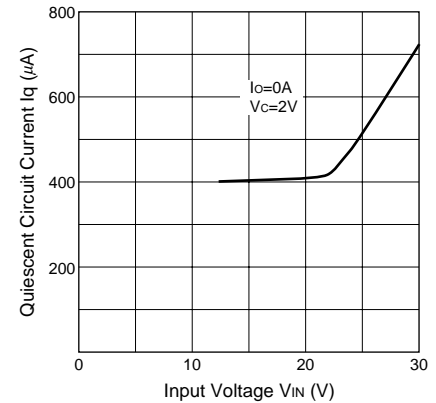

Circuit Current

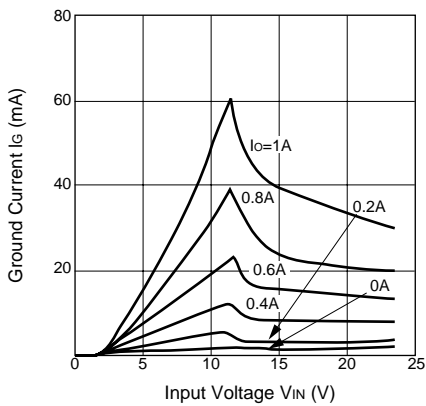

Output ON/OFF Control

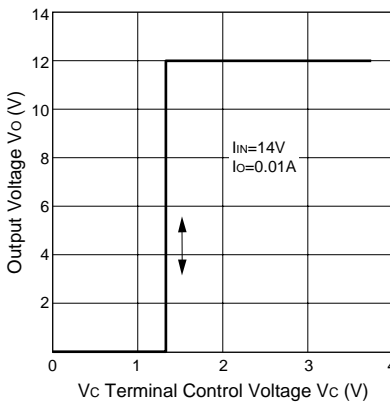

Output ON/OFF Control Current

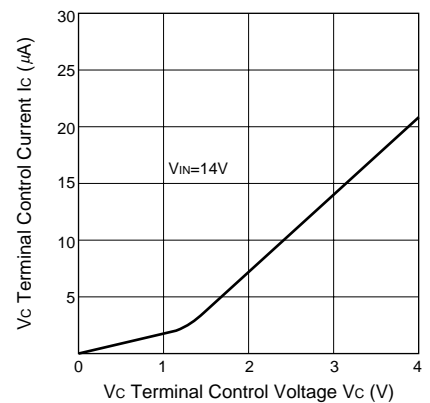

Thermal Protection Characteristics

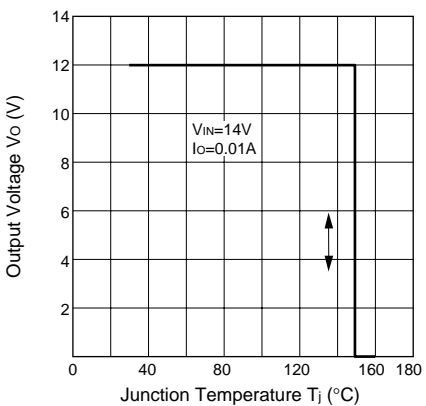

Overinput Voltage Protection Characteristics

