

Features

- Single 10 dB Step
- Low Loss: 0.3 dB @ 900 MHz
- Low Cost SOT-25 Package

Description

M/A-COM's AT-266 is a 1 bit, 10 dB step GaAs MMIC digital attenuator in a low cost SOT-25 surface mount plastic package. The AT-266 is ideally suited for use where high accuracy, very low power consumption and low intermodulation products are required. Typical applications include radio, wireless LANs, GPS equipment and other gain/level control circuits.

The AT-266 is fabricated using a mature GaAs MMIC process featuring full chip passivation for increased performance and reliability.

Ordering Information ¹

Part Number	Package
AT-266	Bulk Packaging
AT-266TR	1000 piece reel

1. Reference Application Note M513 for reel size information.

Absolute Maximum Ratings ^{2,3}

Parameter	Absolute Maximum
Input Power 50 MHz 500 - 2000 MHz	+27 dBm +34 dBm
Control Voltage	$-8.5\text{ V} \leq V_c \leq +8\text{ V}$
Operating Temperature	-40°C to $+85^\circ\text{C}$
Storing Temperature	-65°C to $+150^\circ\text{C}$

- Exceeding any one or combination of these limits may cause permanent damage to this device.
- M/A-COM does not recommend sustained operation near these survivability limits.

Functional Block Diagram

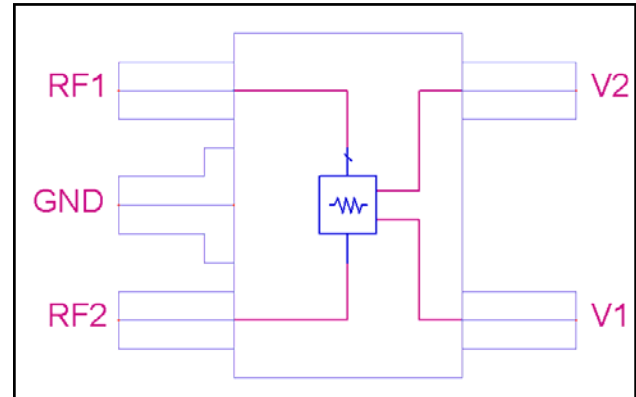

Pin Configuration

Pin No.	Function	Description
1	RF1	RF In/Out
2	GND	RF Ground
3	RF2	RF In/Out
4	V1	Control Voltage
5	V2	Control Voltage

Truth Table ^{4,5,6}

V1	V2	Attenuation State
0	1	10 dB
1	0	Insertion Loss

- For positive voltage control, external DC blocking capacitors are required on all RF ports (pins 1, 2 and 3).
- Differential voltage, $V(\text{state } 1) - V(\text{state } 0)$, must be +2.8 V minimum and less than 8 V.
- $0 = -8\text{ V}$ to 0.2 V , $1 = -0.2\text{ V}$ to 8 V

Electrical Specifications: $T_A = 25^\circ\text{C}$, $V_C = 0\text{ V} / -3\text{ V}$, $Z_0 = 50\ \Omega$

Parameter	Test Conditions	Units	Min.	Typ.	Max.
Insertion Loss	0 - 1 GHz	dB	—	0.3	0.45
	1 - 2 GHz	dB	—	0.5	0.7
Attenuation	DC - 1 GHz	dB	9.6	10	10.4
	1 - 2 GHz	dB	9.5	10	10.5
VSWR	0 - 2 GHz	Ratio	—	1.4:1	1.5:1
IP ₃	2 Tone @ 0 dBm, 5 MHz spacing	dBm	42	50	—
P1dB	1 GHz	dBm	23	28	—
Trise, Tfall	10% to 90% RF, 90% to 10% RF	nS	—	5	20
Ton, Toff	50% Control to 90% RF, 50% Control to 10% RF	nS	—	10	25
Transients	In Band	mV	—	6	10
Control Current	$ V_C = 3\text{ V}$	μA	—	25	—

SOT-25 Plastic Package

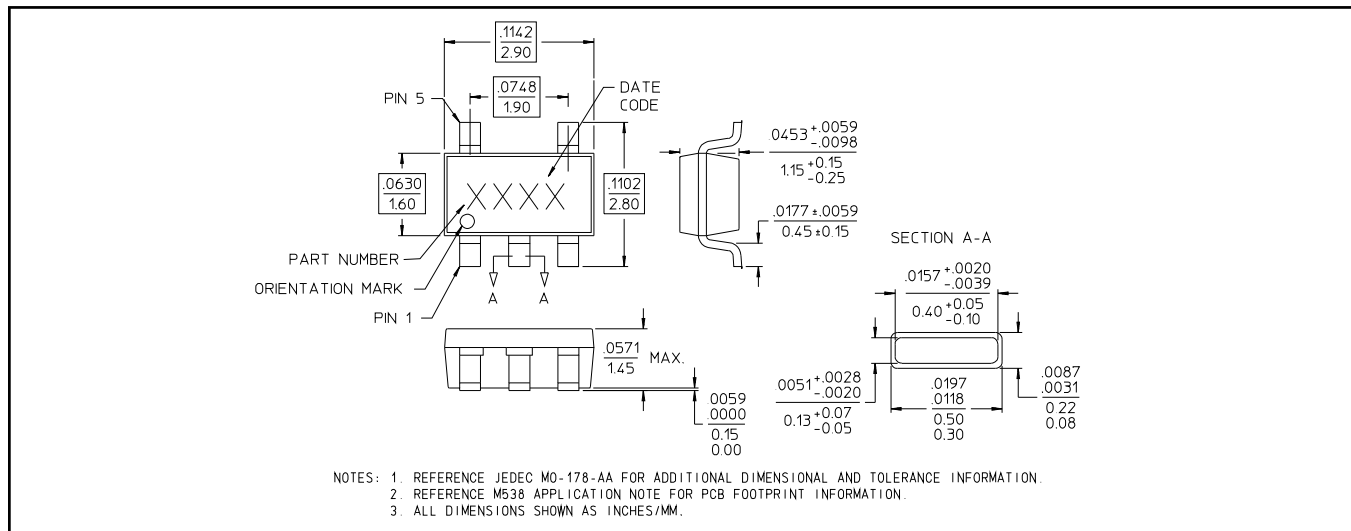

Handling Procedures

Please observe the following precautions to avoid damage:

Static Sensitivity

Gallium Arsenide Integrated Circuits are sensitive to electrostatic discharge (ESD) and can be damaged by static electricity. Proper ESD control techniques should be used when handling these devices.

Typical Performance Curves (39 pF capacitors used for positive voltage control)

Insertion Loss (Positive Control)

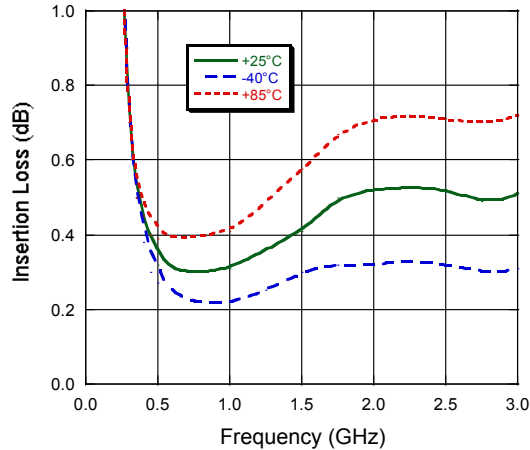

Insertion Loss (Negative Control)

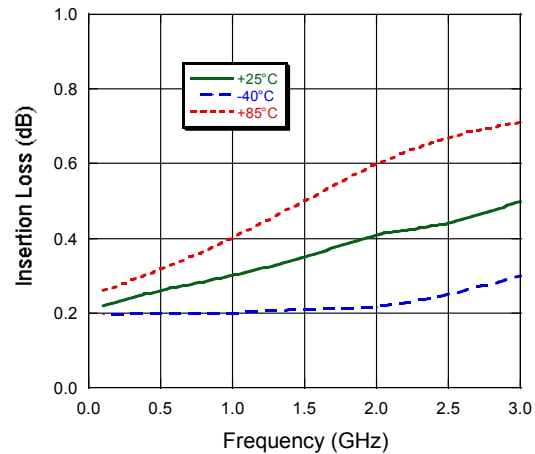

Relative Attenuation (Positive Control)

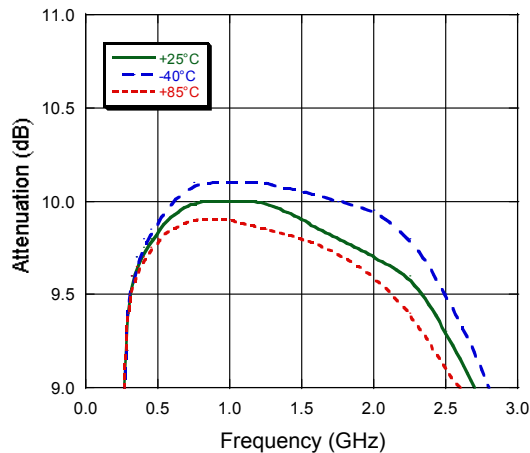

Relative Attenuation (Negative Control)

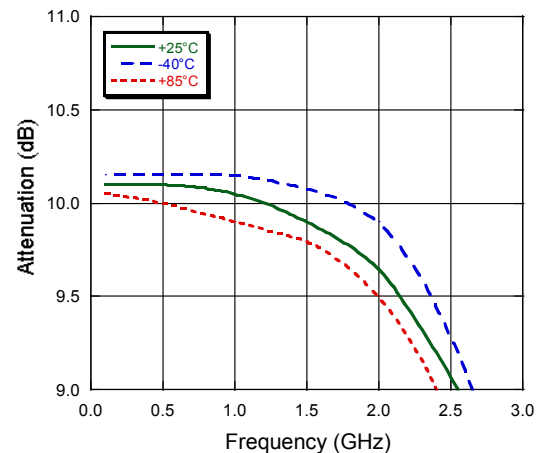

Return Loss (Reference State)

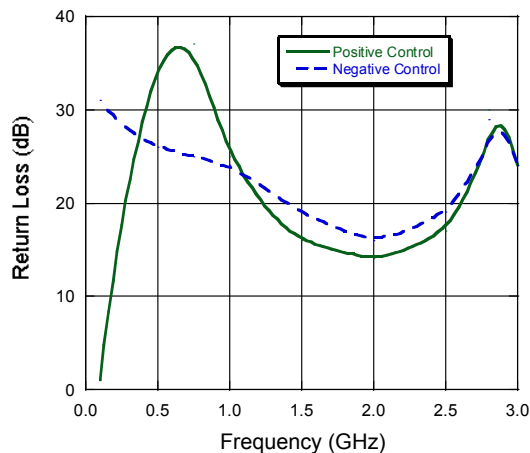

Return Loss (10 dB State)

