

PM600DVA060

FLAT-BASE TYPE
INSULATED PACKAGE

PM600DVA060



FEATURE

- 1φ 600A, 600V Current-sense IGBT for 20kHz switching
- Monolithic gate drive & protection logic
- Detection, protection & status indication circuits for over-current, short-circuit, over-temperature & under-voltage (P-Fo available from upper leg devices)
- Acoustic noise-less 55kW class inverter application
- UL Recognized

Yellow Card No. E80276(N)

File No. E80271

APPLICATION

General purpose inverter, servo drives and other motor controls

PACKAGE OUTLINES

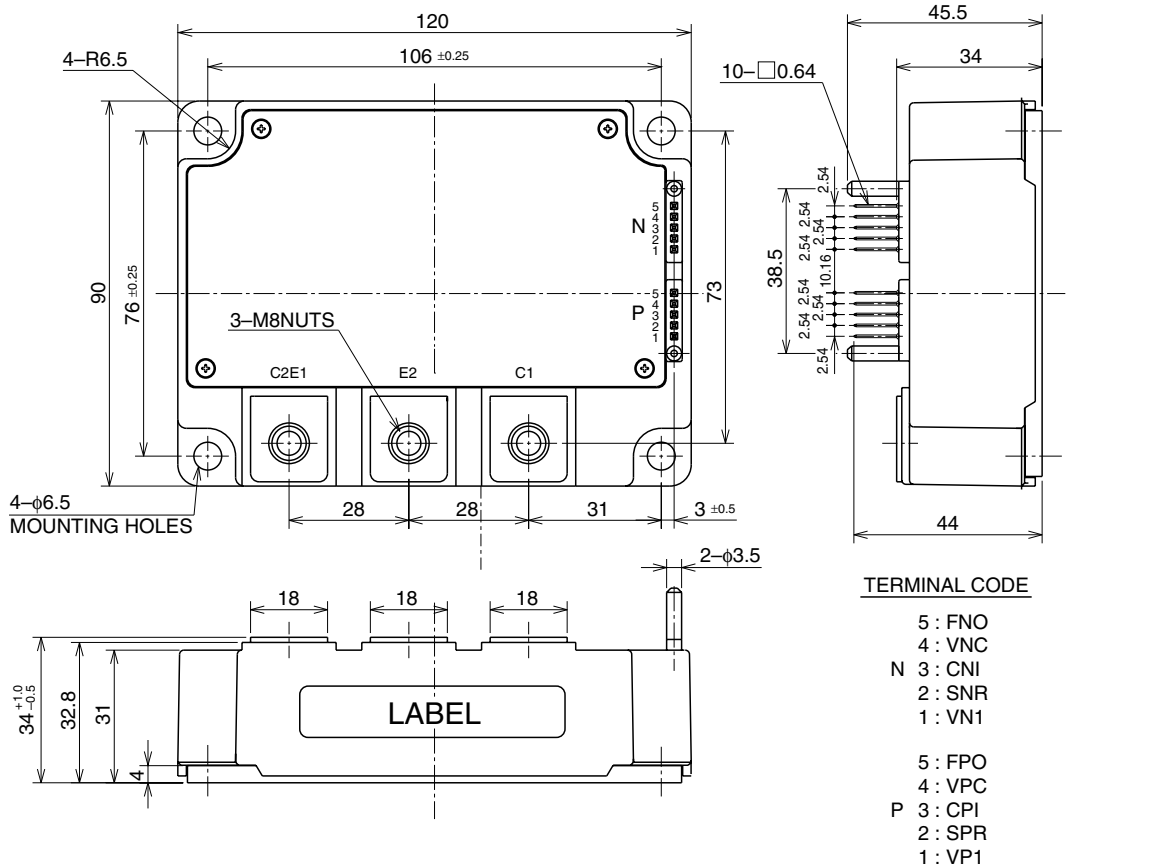

PM600DVA060

FLAT-BASE TYPE
INSULATED PACKAGE

TOTAL SYSTEM

Symbol	Parameter	Condition	Ratings	Unit
V _{CC(PROT)}	Supply Voltage Protected by SC	V _D = 13.5 ~ 16.5V, Inverter Part, T _j = 125°C Start	400	V
V _{CC(surge)}	Supply Voltage (Surge)	Applied between : C1-E2, Surge value or without switching	500	V
T _C	Module Case Operating Temperature	(Note-1)	-20 ~ +100	°C
T _{stg}	Storage Temperature		-40 ~ +125	°C
V _{iso}	Isolation Voltage	60Hz, Sinusoidal, Charged part to Base, AC 1 min.	2500	V _{rms}

(Note-1) T_C measurement point is below. (3mm depth at the center of the side of base plate)

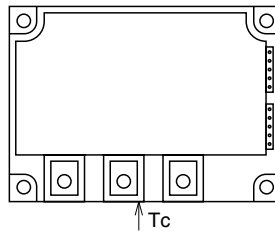

ELECTRICAL CHARACTERISTICS (T_j = 25°C, unless otherwise noted)

INVERTER PART

Symbol	Parameter	Test Condition	Limits			Unit	
			Min.	Typ.	Max.		
V _{CE(sat)}	Collector-Emitter Saturation Voltage	V _D = 15V, I _C = 600A V _{CIN} = 0V	T _j = 25°C	—	2.35	2.80	V
			T _j = 125°C	—	2.55	3.05	
V _{EC}	FWDI Forward Voltage	-I _C = 600A, V _D = 15V, V _{CIN} = 5V	—	2.20	3.30	V	
t _{on}	Switching Time	V _D = 15V, V _{CIN} = 0V↔5V V _{CC} = 300V, I _C = 600A T _j = 125°C Inductive Load (upper and lower arm)	—	0.4	0.8	μs	
t _{rr}			—	0.2	0.3		
t _{c(on)}			—	0.3	1.1		
t _{off}			—	1.8	2.9		
t _{c(off)}			—	0.6	1.2		
I _{CES}	Collector-Emitter Cutoff Current	V _{CE} = V _{CES} , V _{CIN} = 5V	T _j = 25°C	—	—	1	mA
			T _j = 125°C	—	—	10	

CONTROL PART

Symbol	Parameter	Test Condition	Limits			Unit	
			Min.	Typ.	Max.		
I _D	Circuit Current	V _D = 15V, V _{CIN} = 5V	V _{N1} -V _{NC}	—	27	38	mA
			V _{P1} -V _{PC}	—	27	38	
V _{th(ON)}	Input ON Threshold Voltage	Applied between : C _{P1} -V _{PC} , C _{N1} -V _{NC}	1.2	1.5	1.8	V	
V _{th(OFF)}	Input OFF Threshold Voltage		1.7	2.0	2.3		
SC	Short Circuit Trip Level	-20 ≤ T _j ≤ 125°C, V _D = 15V	740	—	—	A	
t _{off(SC)}	Short Circuit Current Delay Time	V _D = 15V	—	10	—	μs	
OT	Over Temperature Protection (Lower-arms only)	Base-plate Temperature detection, V _D = 15V	Trip level	111	118	125	°C
			Reset level	—	100	—	
UV	Supply Circuit Under-Voltage Protection	-20 ≤ T _j ≤ 125°C	Trip level	11.5	12.0	12.5	V
			Reset level	—	12.5	—	
I _{FO(H)}	Fault Output Current	V _D = 15V, V _{FO} = 15V (Note-2)	—	—	0.01	mA	
I _{FO(L)}			—	10	15		
t _{FO}	Minimum Fault Output Pulse Width	V _D = 15V (Note-2)	1.0	1.8	—	ms	
V _{SXR}	SXR Terminal Output Voltage	-20 ≤ T _j ≤ 125°C, R _{in} =6.8kΩ	4.5	5.1	5.6	V	

(Note-2) Fault output is given only when the internal SC, OT & UV protection.
 Fault output of OT protection operate by lower arm
 Fault output of OT, UV protection given pulse while over level.

PM600DVA060

FLAT-BASE TYPE
INSULATED PACKAGE

THERMAL RESISTANCES

Symbol	Parameter	Test Condition	Limits			Unit
			Min.	Typ.	Max.	
R _{th(j-c)Q}	Junction to case Thermal Resistances	Inverter IGBT part (per 1/2 module)	—	—	0.099	°C/W
R _{th(j-c)F}		Inverter FWDi part (per 1/2 module)	—	—	0.13	
R _{th(c-f)}	Contact Thermal Resistance	Case to fin, Thermal grease applied (per 1/2 module)	—	—	0.065	

MECHANICAL RATINGS AND CHARACTERISTICS

Symbol	Parameter	Test Condition	Limits			Unit
			Min.	Typ.	Max.	
—	Mounting torque	Mounting part screw : M6	3.92	4.90	5.88	N • m
—	Mounting torque	Main terminal screw : M8	8.83	9.81	10.8	N • m
—	Weight		—	720	—	g

RECOMMENDED CONDITIONS FOR USE

Symbol	Parameter	Test Condition	Recommended value	Unit
V _{CC}	Supply Voltage	Applied across C1-E2 terminals	≤ 400	V
V _D	Control Supply Voltage	Applied between : V _{P1} -V _{PC} , V _{N1} -V _{NC} (Note-3)	15 ± 1.5	V
V _{CIN(ON)}	Input ON Voltage	Applied between : C _{P1} -V _{PC} , C _{N1} -V _{NC}	≤ 0.8	V
V _{CIN(OFF)}	Input OFF Voltage		≥ 4.0	
t _{dead}	Arm Shoot-through Blocking Time	For IPM's each input signals	≥ 3.0	μs
f _{PWM}	PWM Input Frequency	Using Application Circuit input signal of IPM, 3φ Sinusoidal PWM VVVF inverter	≤ 20	kHz

(Note-3) With ripple satisfying the following conditions dv/dt swing ≤ ±5V/μs, Variation ≤ 2V peak to peak

PM600DVA060

FLAT-BASE TYPE
INSULATED PACKAGE

PERFORMANCE CURVES

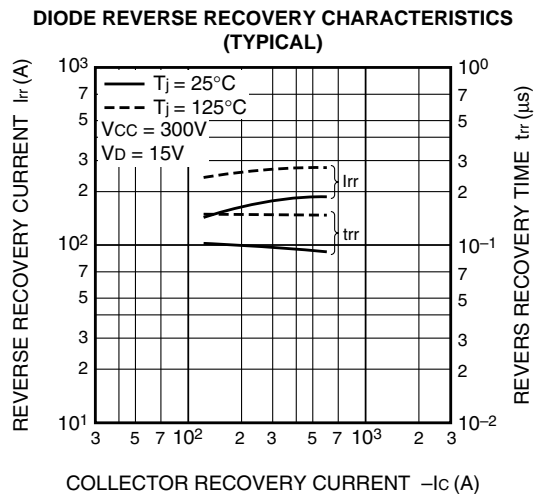
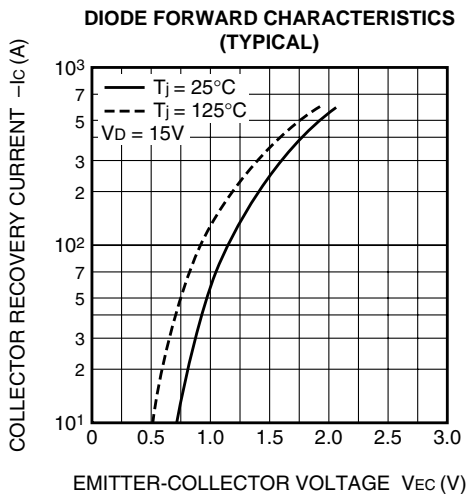
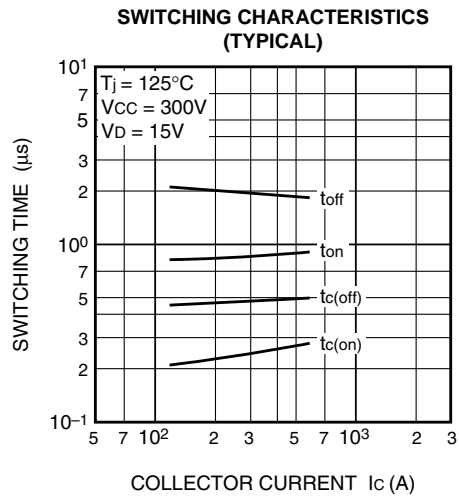
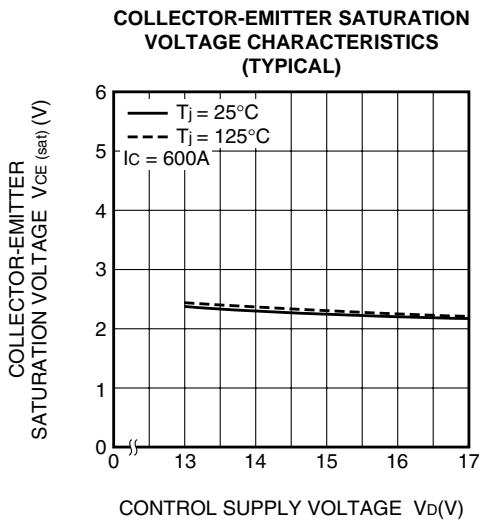
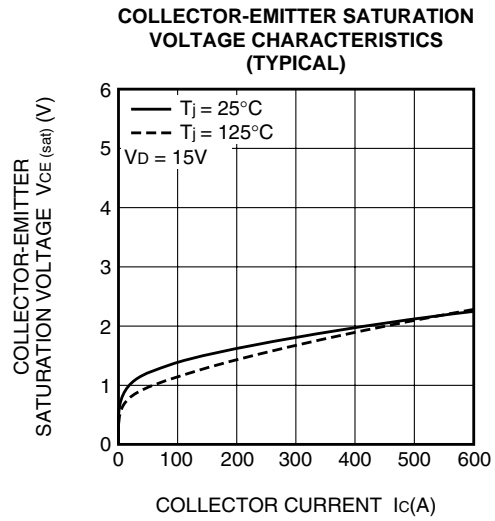
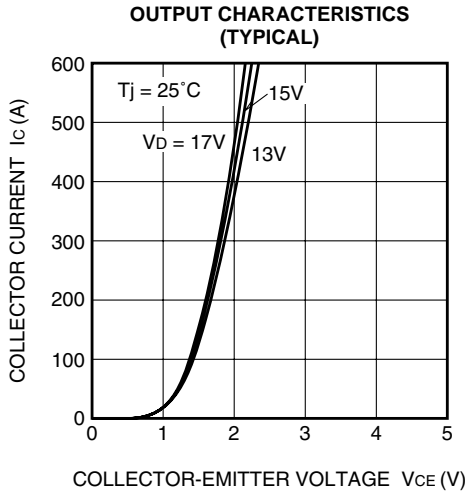

PM600DVA060

FLAT-BASE TYPE
INSULATED PACKAGE

**TRANSIENT THERMAL
IMPEDANCE CHARACTERISTICS
(IGBT per 1 element)**

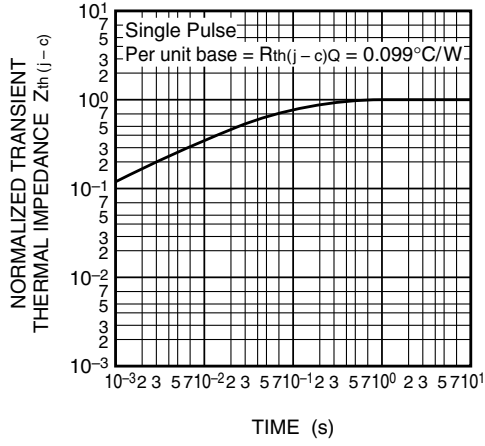

**TRANSIENT THERMAL
IMPEDANCE CHARACTERISTICS
(FWDi per 1 element)**

