



Spec. No.	PS-ND-0807
Rev.	A

# PRODUCT SPECIFICATION

**Model No : CSS-312T9/313T9**

## Descriptions:

- 0.30 Inch Single Digit Display
- Emitting Color : Super Bright Yellow



CUSTOMER APPROVED	APPROVED BY	CHECKED BY	PREPARED BY
SIGNATURES			陳新強

CHINA SEMICONDUCTOR CORPORATION  
Address:2FL. NO.909,Chung-Cheng Road,  
Chung-Ho City Taipei Hsien,Taiwan.

Tel:886-2-2223-9696  
Fax:886-2-2223-9377

OPTO PLUS TECHNOLOGIES CO.,LTD  
Address:696 Shun jiang Rd.,Ji Shan St.Shaoxing,  
ZheJiang,China

Tel:86-0575-88623888  
Fax:86-0575-88623112



**Model No:** CSS-312T9/313T9

■ **Features -**

1. 0.30 inch (7.8mm) digit height.
2. Case mold type.
3. RoHs compliant.
4. Low power consumption.
5. Easy mounting on P.C. board or socket.

■ **Device Selection Guide -**

Model No.	Chip		Description
	Material	Emitted Color	
<b>CSS-312T9</b>	<b>AlGaInP</b>	<b>Super Bright Yellow</b>	<b>Common Anode</b>
<b>CSS-313T9</b>	<b>AlGaInP</b>	<b>Super Bright Yellow</b>	<b>Common Cathode</b>

■ **Mechanical Dimensions -**

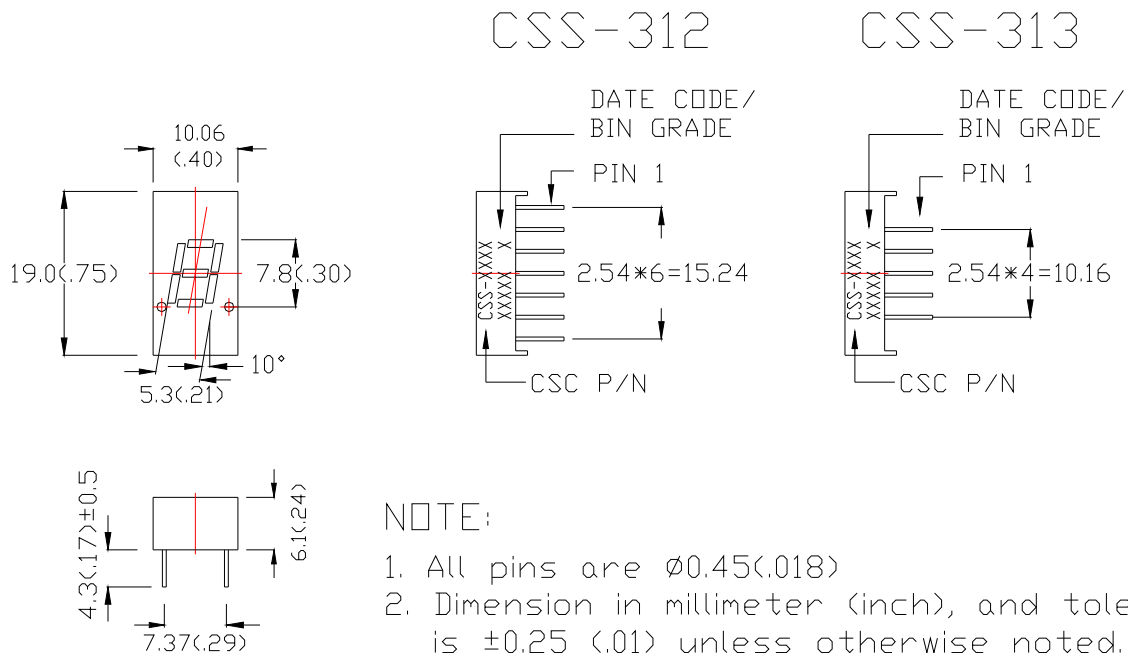



**Model No : CSS-312T9/313T9**

**Internal Circuit Diagrams -**

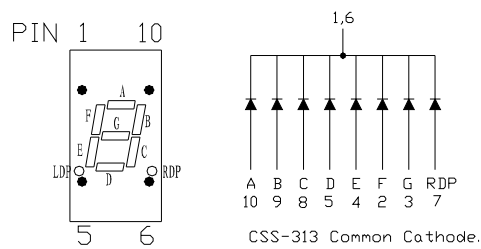
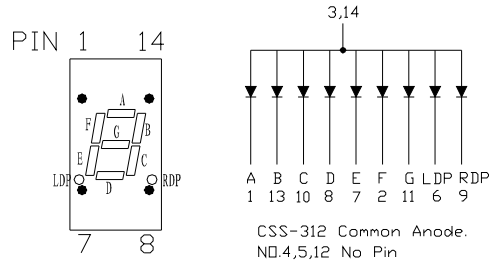

**Absolute Maximum Rating -**

(Ta=25°C)

Parameter	Symbol	Rating	Unit
Power Dissipation Per Dice	Pd	70	mW
Continuous Forward Current Per Dice	IAF	25	mA
Peak Current Per Dice	IPF	90	mA
Continuous Forward Current Per Dice	-	0.33	mA/°C
Reverse Voltage Per Dice	VR	5	V
Operating Temperature	Topr	-35 ~ +85	°C
Storage Temperature	Tstg	-35 ~ +85	°C
Solder temperature 1/16 inch below seating plane for 3 seconds at 260 °C			



Model No : CSS-312T9/313T9

■ Electro-optical Characteristics -

(Ta=25°C)

Parameter	Symbol	Min.	Typ.	Max.	Unit	Condition
Forward Voltage Per Segment	VF	-	2.1	2.8	V	IF=20mA
Luminous Intensity Per Segment	Iv	5000	12000	-	ucd	IF=10mA
Peak Emission Wavelength	$\lambda P$	-	592	-	nm	IF=20mA
Dominant Wavelength	$\lambda d$	-	590	-	nm	IF=20mA
Spectrum Radiation Bandwidth	$\Delta \lambda$	-	20	-	nm	IF=20mA
Reverse Current	IR	-	-	100	$\mu A$	VR=5V
Luminous Intensity Matching Ratio	IV-m	-	-	2:1	-	IF=10mA



Model No : CSS-312T9/313T9

### Typical Electrical / Optical Characteristics Curves -

(Ta = 25°C Unless Otherwise Noted)

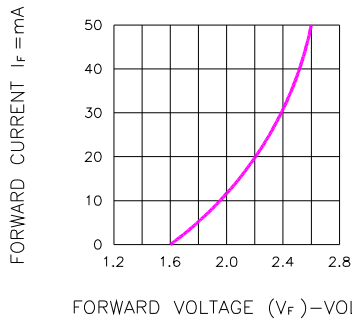

Fig.1 FORWARD CURRENT VS. FORWARD VOLTAGE

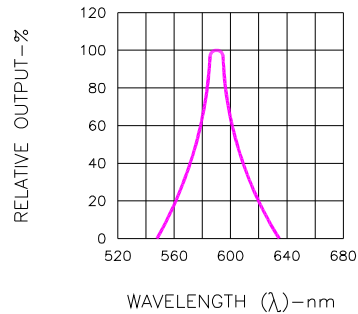

Fig.2 SPECTRAL RESPONSE

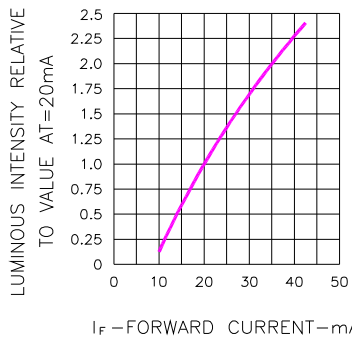

Fig.3 RELATIVE LUMINOUS INTENSITY VS. FORWARD CURRENT

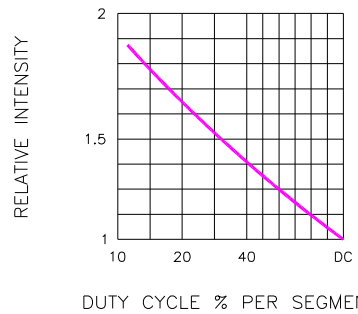

Fig.5 LUMINOUS INTENSITY VS. DUTY CYCLE  
(AVERAGE I<sub>F</sub> = 10mA)

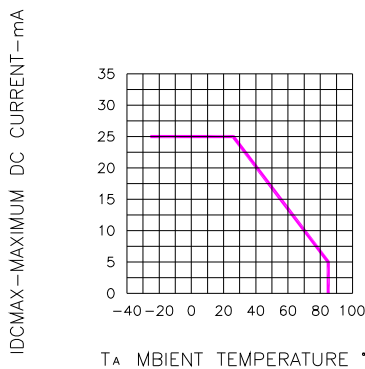

Fig.4 MAXIMUM ALLOWABLE DC CURRENT PER SEGMENT VS. A FUNCTION OF AMBIENT TEMPERATURE

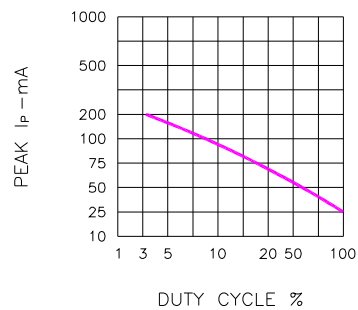

Fig.6 MAX PEAK CURRENT VS. DUTY CYCLE %  
(REFRESH RATE f = 1 KHz)



Spec. No.	PS-ND-0807
Rev.	A

Model No: CSS-312T9/313T9

■ Package Dimensions

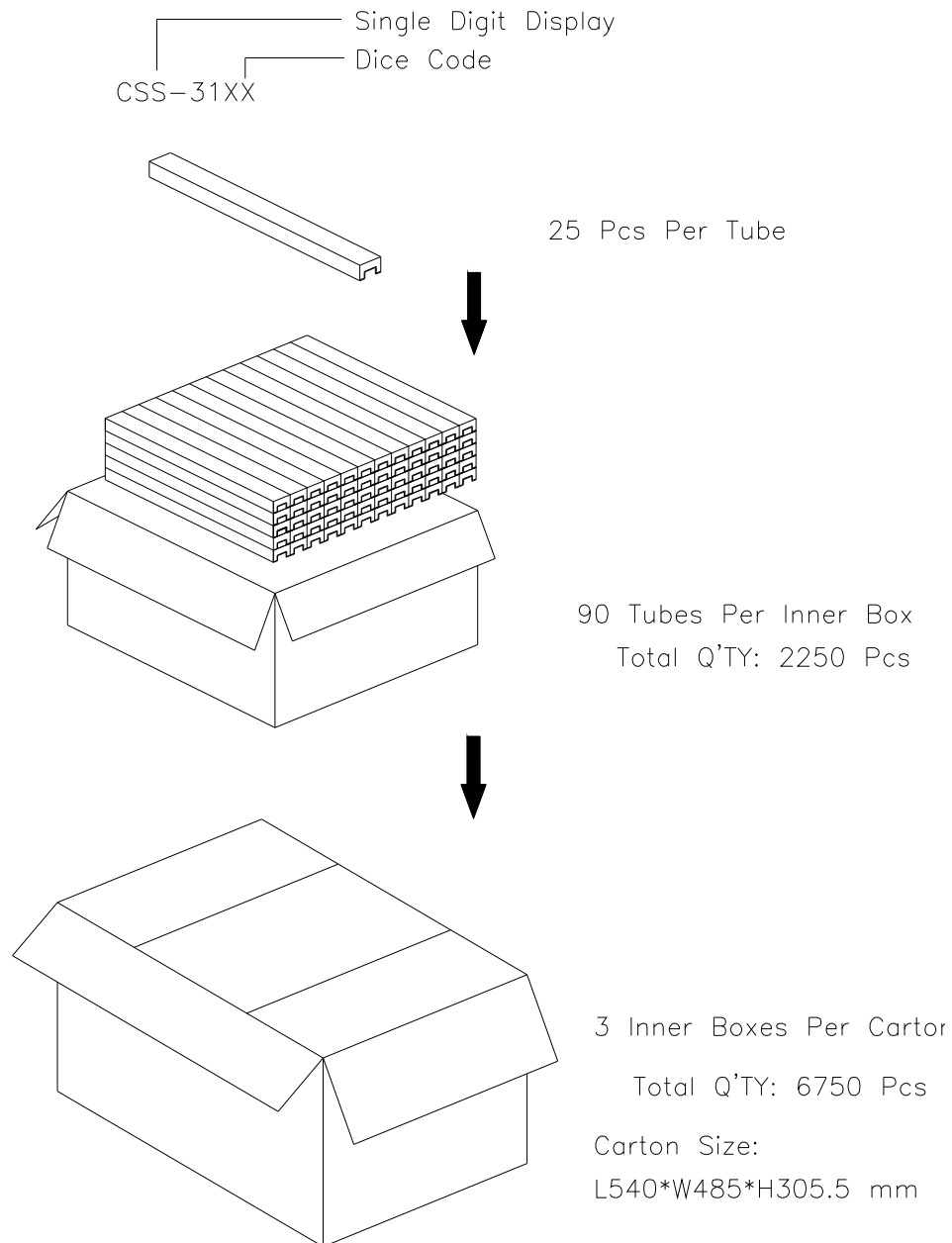

Note: The specifications are subject to change without notice. Please contact us for updated information

<http://www.csctw.com.tw>