

2.6W Stereo Audio Power Amplifier and DirectDrive Headphone Amplifier

General Description

The MAX9779 combines a stereo, 2.6W audio power amplifier and stereo DirectDrive™ 110mW headphone amplifier in a single device. The headphone amplifier uses Maxim's patented DirectDrive architecture that produces a ground-referenced output from a single supply, eliminating the need for large DC-blocking capacitors, saving cost, space, and component height. A high 90dB PSRR and low 0.01% THD+N ensures clean, low-distortion amplification of the audio signal through the Class AB speaker amplifiers.

The MAX9779 features a single-supply voltage, a shutdown mode, logic-selectable gain, and a headphone sense input. Industry-leading click-and-pop suppression eliminates audible transients during power and shutdown cycles.

The MAX9779 is offered in a space-saving, thermally efficient 28-pin thin QFN (5mm x 5mm x 0.8mm) package. The device has thermal-overload and output short-circuit protection, and is specified over the extended -40°C to +85°C temperature range.

Applications

Notebook PCs Flat-Panel TVs
Tablet PCs Multimedia Monitors
Portable DVD Players LCD Projectors

Simplified Block Diagram

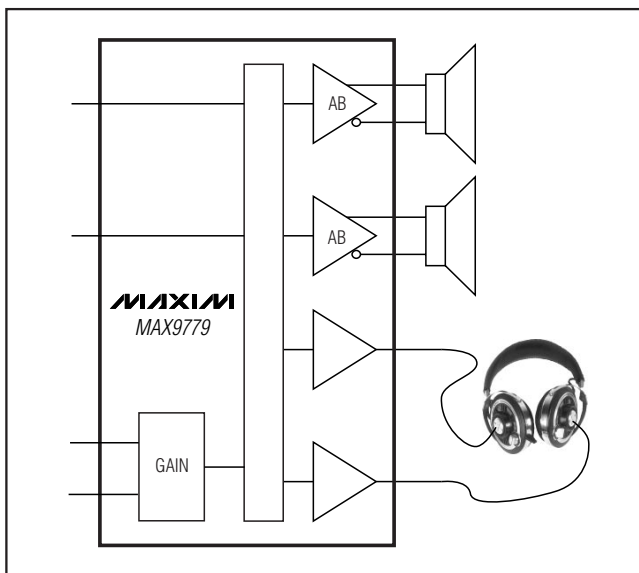

Features

- ◆ No DC-Blocking Capacitors Required—Provides Industry's Most Compact Notebook Audio Solution
- ◆ PC2001 Compliant
- ◆ 5V Single-Supply Operation
- ◆ Class AB 2.6W Stereo BTL Speaker Amplifiers
- ◆ 110mW DirectDrive Headphone Amplifiers
- ◆ High 90dB PSRR
- ◆ Low-Power Shutdown Mode
- ◆ Industry-Leading Click-and-Pop Suppression
- ◆ Low 0.01% THD+N at 1kHz
- ◆ Short-Circuit and Thermal-Overload Protection
- ◆ Selectable Gain Settings (15dB, 16.5dB, 18dB, and 19.5dB)
- ◆ ±8kV ESD-Protected Headphone Driver Outputs
- ◆ Available in Space-Saving, Thermally Efficient Package
28-Pin Thin QFN (5mm x 5mm x 0.8mm)

Ordering Information

PART	TEMP RANGE	PIN-PACKAGE
MAX9779ETI+	-40°C to +85°C	28 Thin QFN-EP*

+Denotes lead-free package.

*EP = Exposed paddle.

Pin Configuration appears at end of data sheet.

2.6W Stereo Audio Power Amplifier and DirectDrive Headphone Amplifier

ABSOLUTE MAXIMUM RATINGS

Supply Voltage (V_{DD}, PV_{DD}, HPV_{DD}, CPV_{DD} to GND)+6V
 GND to PGND±0.3V
 CPV_{SS}, C1N, V_{SS} to GND-6.0V to (GND + 0.3V)
 HPOUT₋ to GND±3V
 Any Other Pin-0.3V to (V_{DD} + 0.3V)
 Duration of OUT₋ Short Circuit to GND or PV_{DD}Continuous
 Duration of OUT₊ Short Circuit to OUT₋Continuous
 Duration of HPOUT₋ Short Circuit to GND,
 V_{SS} or HPV_{DD}Continuous
 Continuous Current (PV_{DD}, OUT₋, PGND)1.7A

Continuous Current (CPV_{DD}, C1N, C1P, CPV_{SS}, V_{SS}, HPV_{DD},
 HPOUT₋)850mA
 Continuous Input Current (all other pins)±20mA
 Continuous Power Dissipation (T_A = +70°C)
 28-Pin Thin QFN (derate 20.8mW/°C above +70°C) ..1667mW
 Junction Temperature+150°C
 Operating Temperature Range-40°C to +85°C
 Storage Temperature Range-65°C to +150°C
 Lead Temperature (soldering, 10s)+300°C

Stresses beyond those listed under "Absolute Maximum Ratings" may cause permanent damage to the device. These are stress ratings only, and functional operation of the device at these or any other conditions beyond those indicated in the operational sections of the specifications is not implied. Exposure to absolute maximum rating conditions for extended periods may affect device reliability.

ELECTRICAL CHARACTERISTICS

(V_{DD} = PV_{DD} = CPV_{DD} = HPV_{DD} = 5V, GND = PGND = CPGND = 0V, $\overline{\text{SHDN}}$ = V_{DD}, C_{BIAS} = 1μF, C1 = C2 = 1μF, speaker load terminated between OUT₊ and OUT₋, headphone load terminated between HPOUT₋ and GND, GAIN1 = GAIN2 = 0V, T_A = T_{MIN} to T_{MAX}, unless otherwise noted. Typical values are at T_A = +25°C.) (Note 1)

PARAMETER	SYMBOL	CONDITIONS	MIN	TYP	MAX	UNITS
GENERAL						
Supply Voltage Range	V _{DD} , PV _{DD}	Inferred from PSRR test	4.5		5.5	V
Headphone Supply Voltage	CPV _{DD} , HPV _{DD}	Inferred from PSRR test	3.0		5.5	V
Quiescent Supply Current	I _{DD}	HPS = GND, speaker mode, R _L = ∞		14	29	mA
		HPS = V _{DD} , headphone mode, R _L = ∞		7	13	
Shutdown Supply Current	I _{SHDN}	$\overline{\text{SHDN}}$ = GND		0.2	5	μA
Bias Voltage	V _{BIAS}		1.7	1.8	1.9	V
Switching Time	t _{SW}	Gain or input switching		10		μs
Input Resistance	R _{IN}	Amplifier inputs (Note 2)	10	20	30	kΩ
Turn-On Time	t _{SON}			25		ms
SPEAKER AMPLIFIER (HPS = GND)						
Output Offset Voltage	V _{OS}	Measured between OUT ₊ and OUT ₋ , T _A = +25°C		±1	±15	mV
Power-Supply Rejection Ratio (Note 3)	PSRR	PV _{DD} or V _{DD} = 4.5V to 5.5V (T _A = +25°C)	75	90		dB
		f = 1kHz, V _{RIPPLE} = 200mV _{P-P}		80		
		f = 10kHz, V _{RIPPLE} = 200mV _{P-P}		55		

2.6W Stereo Audio Power Amplifier and DirectDrive Headphone Amplifier

MAX9779

ELECTRICAL CHARACTERISTICS (continued)

($V_{DD} = P_{VDD} = CP_{VDD} = HP_{VDD} = 5V$, $GND = PGND = CPGND = 0V$, $\overline{SHDN} = V_{DD}$, $C_{BIAS} = 1\mu F$, $C1 = C2 = 1\mu F$, speaker load terminated between OUT_{+} and OUT_{-} , headphone load terminated between $HPOUT_{-}$ and GND , $GAIN1 = GAIN2 = 0V$, $T_A = T_{MIN}$ to T_{MAX} , unless otherwise noted. Typical values are at $T_A = +25^{\circ}C$.) (Note 1)

PARAMETER	SYMBOL	CONDITIONS	MIN	TYP	MAX	UNITS
Output Power (Note 4)	P_{OUT}	THD+N = 1%, f = 1kHz, $T_A = +25^{\circ}C$	$R_L = 8\Omega$	0.9	1.4	W
			$R_L = 4\Omega$		2.3	
			$R_L = 3\Omega$		2.6	
Total Harmonic Distortion Plus Noise	THD+N	$R_L = 8\Omega$, $P_{OUT} = 500mW$, f = 1kHz		0.01		%
		$R_L = 4\Omega$, $P_{OUT} = 1W$, f = 1kHz		0.02		
Signal-to-Noise Ratio	SNR	$R_L = 8\Omega$, $P_{OUT} = 500mW$, BW = 22Hz to 22kHz		90		dB
Noise	V_n	BW = 22Hz to 22kHz, A-weighted		80		μV_{RMS}
Capacitive-Load Drive	C_L	No sustained oscillations		200		pF
Crosstalk		L to R, R to L, f = 10kHz		75		dB
Slew Rate	SR			1.4		V/ μs
Gain (Maximum Volume Setting)	$A_{VMAX(SPKR)}$	GAIN1 = 0, GAIN2 = 0		15		dB
		GAIN1 = 1, GAIN2 = 0		16.5		
		GAIN1 = 0, GAIN2 = 1		18		
		GAIN1 = 1, GAIN2 = 1		19.5		
HEADPHONE AMPLIFIER (HPS = V_{DD})						
Output Offset Voltage	V_{OS}	$T_A = +25^{\circ}C$		± 2	± 7	mV
Power-Supply Rejection Ratio (Note 3)	PSRR	HPVDD = 3V to 5.5V, $T_A = +25^{\circ}C$		60	75	dB
		f = 1kHz, $V_{RIPPLE} = 200mV_{P-P}$		73		
		f = 10kHz, $V_{RIPPLE} = 200mV_{P-P}$		63		
Output Power	P_{OUT}	THD+N = 1%, f = 1kHz, $T_A = +25^{\circ}C$	$R_L = 32\Omega$	40	50	mW
			$R_L = 16\Omega$		110	
Total Harmonic Distortion Plus Noise	THD+N	$R_L = 32\Omega$, $P_{OUT} = 20mW$, f = 1kHz		0.007		%
		$R_L = 16\Omega$, $P_{OUT} = 75mW$, f = 1kHz		0.03		
Signal-to-Noise Ratio	SNR	$R_L = 32\Omega$, $P_{OUT} = 50mW$, BW = 22Hz to 22kHz		95		dB
Noise	V_n	BW = 22Hz to 22kHz		12		μV_{RMS}
Capacitive-Load Drive	C_L	No sustained oscillations		200		pF
Crosstalk		L to R, R to L, f = 10kHz		88		dB
Off-Isolation		Any unselected input to any active input, f = 10kHz, input referred		74		
Slew Rate	SR			0.4		V/ μs
ESD	ESD	IEC air discharge		± 8		kV
Gain	A_V	GAIN2 = 0, GAIN1 = X		0		dB
		GAIN2 = 1, GAIN1 = X		3		

2.6W Stereo Audio Power Amplifier and DirectDrive Headphone Amplifier

ELECTRICAL CHARACTERISTICS (continued)

($V_{DD} = PV_{DD} = CPV_{DD} = HPV_{DD} = 5V$, $GND = PGND = CPGND = 0V$, $\overline{SHDN} = V_{DD}$, $C_{BIAS} = 1\mu F$, $C1 = C2 = 1\mu F$, speaker load terminated between OUT_{+} and OUT_{-} , headphone load terminated between $HPOUT_{-}$ and GND , $GAIN1 = GAIN2 = 0V$, $T_A = T_{MIN}$ to T_{MAX} , unless otherwise noted. Typical values are at $T_A = +25^{\circ}C$.) (Note 1)

PARAMETER	SYMBOL	CONDITIONS	MIN	TYP	MAX	UNITS
CHARGE PUMP						
Charge-Pump Frequency	f_{OSC}		500	550	600	kHz
LOGIC INPUT (\overline{SHDN}, $GAIN1$, $GAIN2$)						
Logic-Input High Voltage	V_{IH}		2			V
Logic-Input Low Voltage	V_{IL}				0.8	V
Logic-Input Current	I_{IN}				± 1	μA
LOGIC-INPUT HEADPHONE (HPS)						
Logic-Input High Voltage	V_{IH}		2			V
Logic-Input Low Voltage	V_{IL}				0.8	V
Logic-Input Current	I_{IN}			10		μA

Note 1: All devices are 100% production tested at room temperature. All temperature limits are guaranteed by design.

Note 2: Guaranteed by design. Not production tested.

Note 3: PSRR is specified with the amplifier input connected to GND through C_{IN} .

Note 4: Output power levels are measured with the thin QFN's exposed paddle soldered to the ground plane.

2.6W Stereo Audio Power Amplifier and DirectDrive Headphone Amplifier

Typical Operating Characteristics

(Measurement BW = 22Hz to 22kHz, $T_A = +25^\circ\text{C}$, unless otherwise noted.)

MAX9779

TOTAL HARMONIC DISTORTION PLUS NOISE vs. FREQUENCY (SPEAKER MODE)

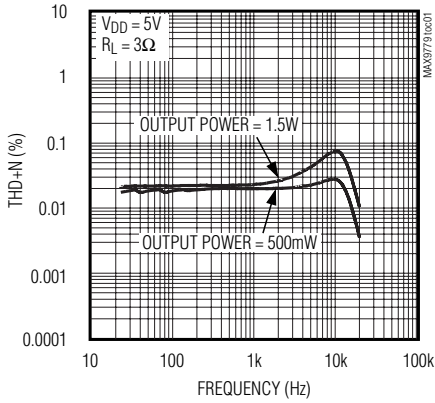

TOTAL HARMONIC DISTORTION PLUS NOISE vs. FREQUENCY (SPEAKER MODE)

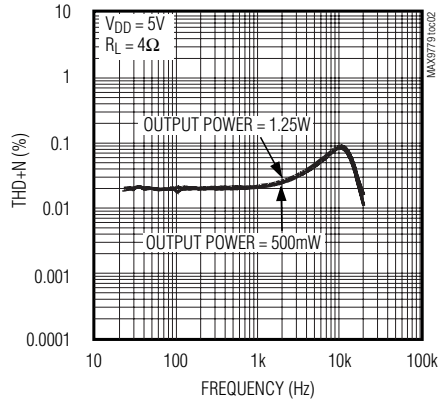

TOTAL HARMONIC DISTORTION PLUS NOISE vs. FREQUENCY (SPEAKER MODE)

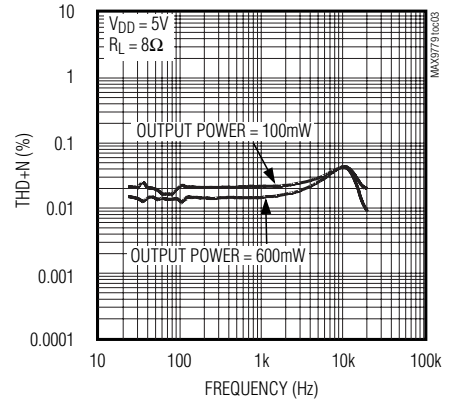

TOTAL HARMONIC DISTORTION PLUS NOISE vs. OUTPUT POWER (SPEAKER MODE)

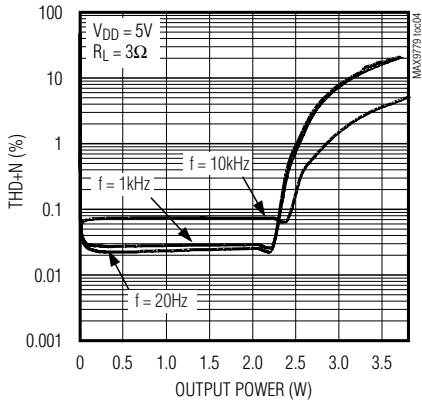

TOTAL HARMONIC DISTORTION PLUS NOISE vs. OUTPUT POWER (SPEAKER MODE)

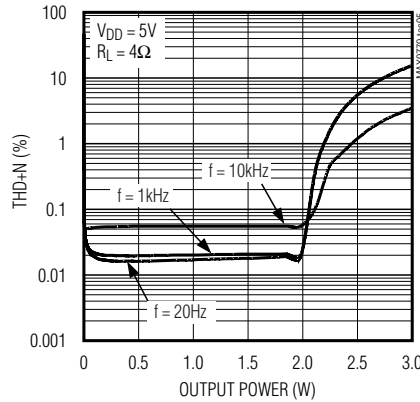

TOTAL HARMONIC DISTORTION PLUS NOISE vs. OUTPUT POWER (SPEAKER MODE)

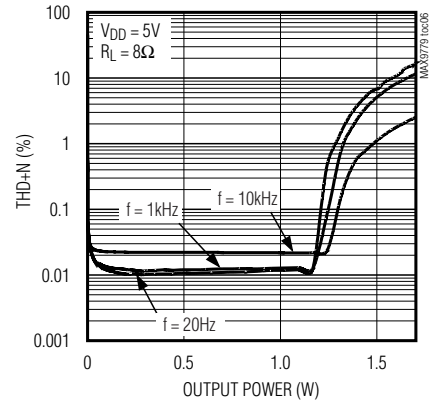

OUTPUT POWER vs. LOAD RESISTANCE (SPEAKER MODE)

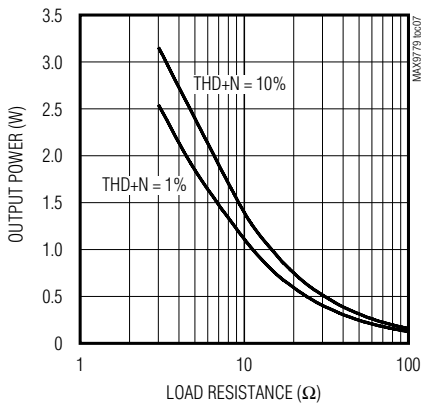

POWER DISSIPATION vs. OUTPUT POWER (SPEAKER MODE)

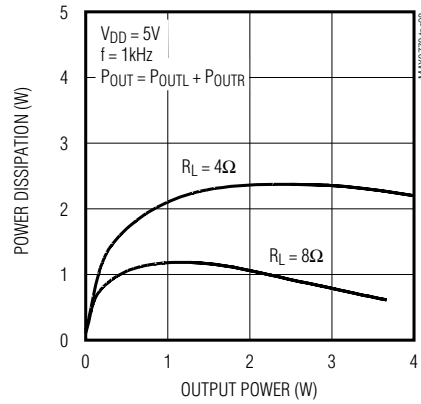

POWER-SUPPLY REJECTION RATIO vs. FREQUENCY (SPEAKER MODE)

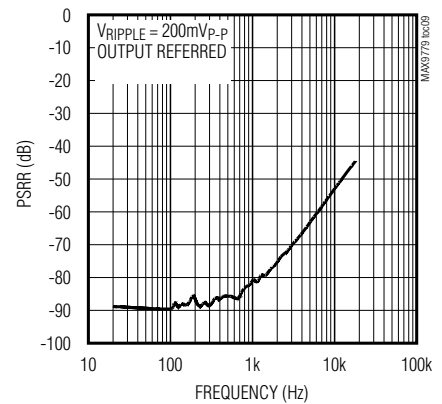

2.6W Stereo Audio Power Amplifier and DirectDrive Headphone Amplifier

Typical Operating Characteristics (continued)

(Measurement BW = 22Hz to 22kHz, T_A = +25°C, unless otherwise noted.)

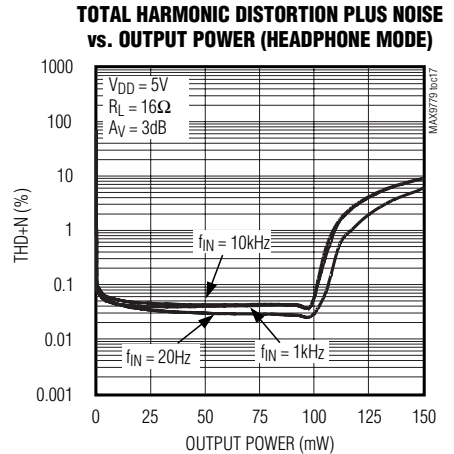
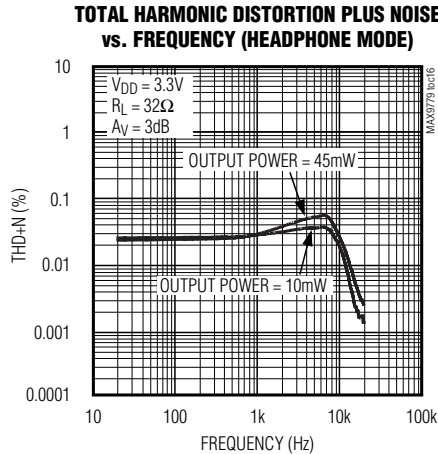
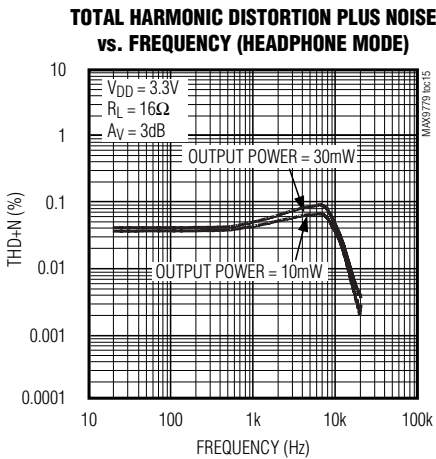
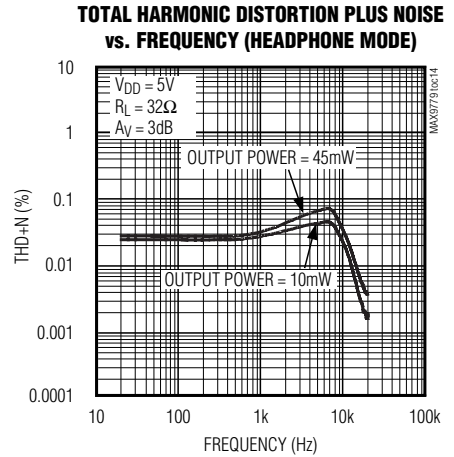
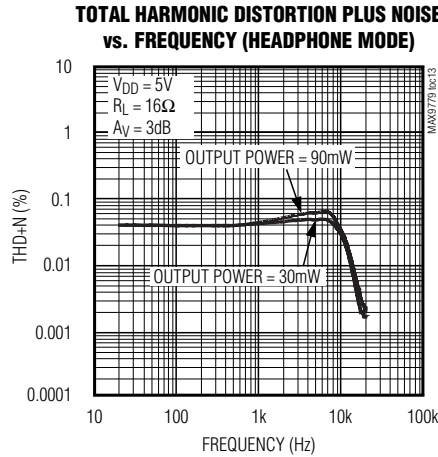
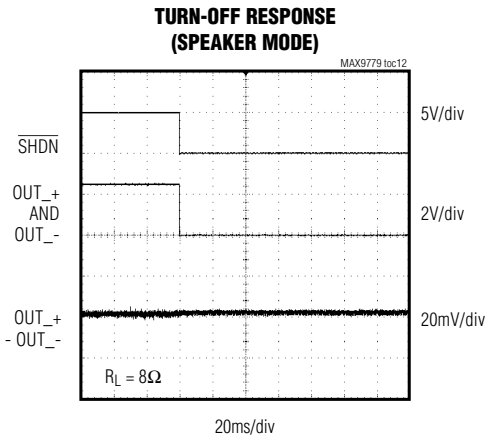
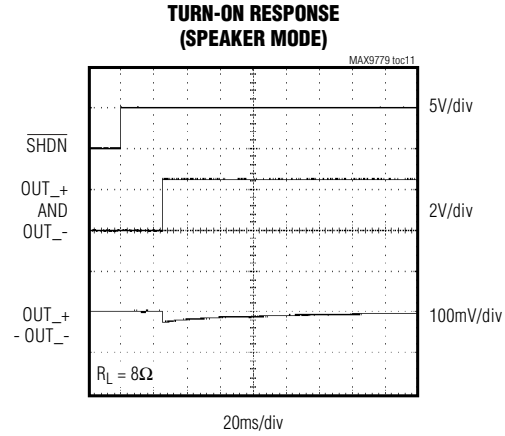
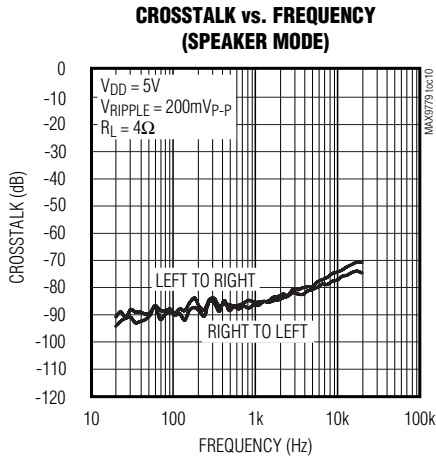

2.6W Stereo Audio Power Amplifier and DirectDrive Headphone Amplifier

MAX9779

Typical Operating Characteristics (continued)

(Measurement BW = 22Hz to 22kHz, $T_A = +25^\circ\text{C}$, unless otherwise noted.)

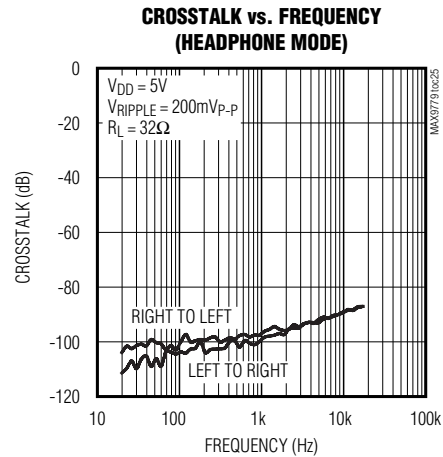
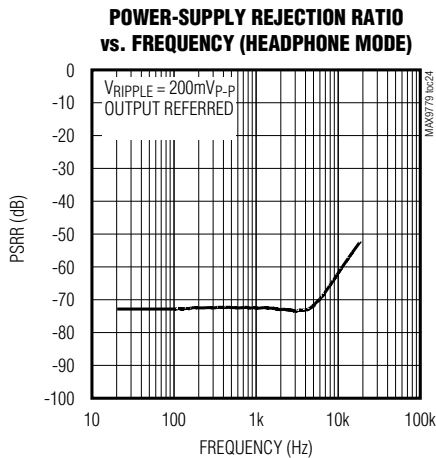
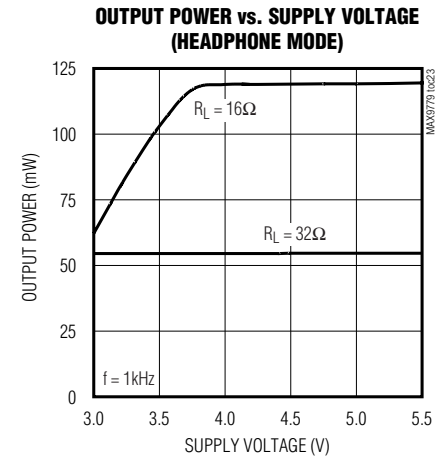
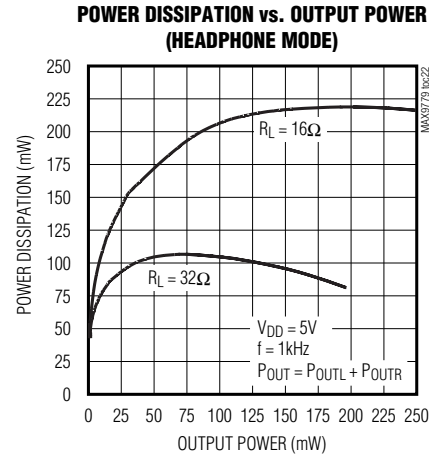
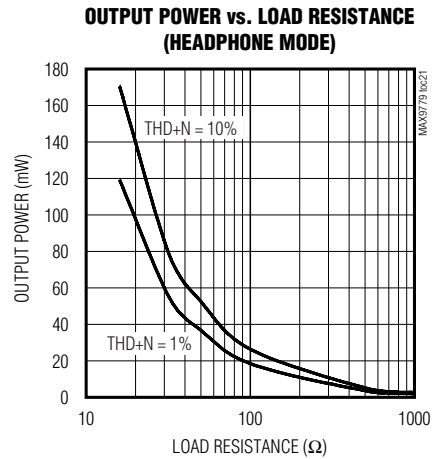
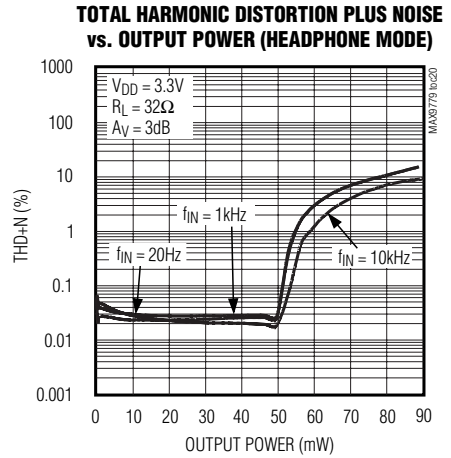
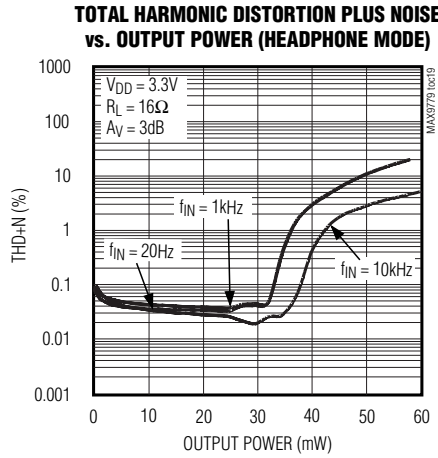
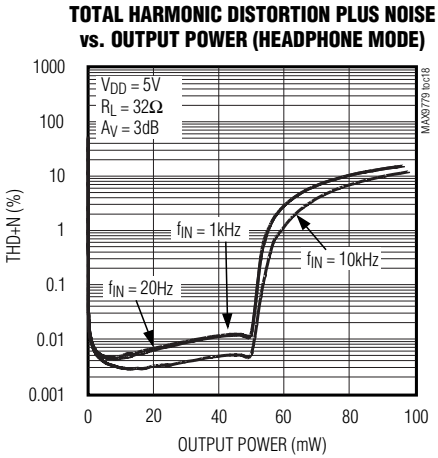

2.6W Stereo Audio Power Amplifier and DirectDrive Headphone Amplifier

Typical Operating Characteristics (continued)

(Measurement BW = 22Hz to 22kHz, $T_A = +25^\circ\text{C}$, unless otherwise noted.)

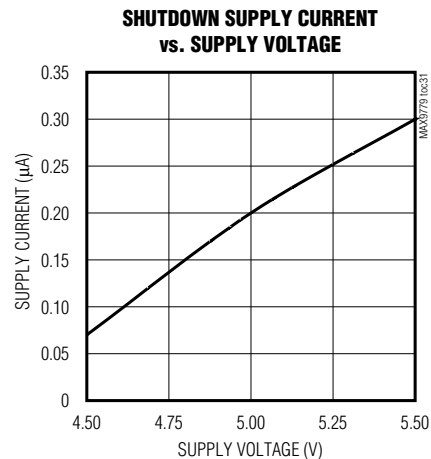
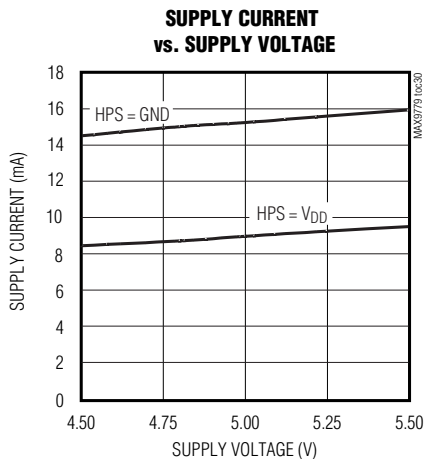
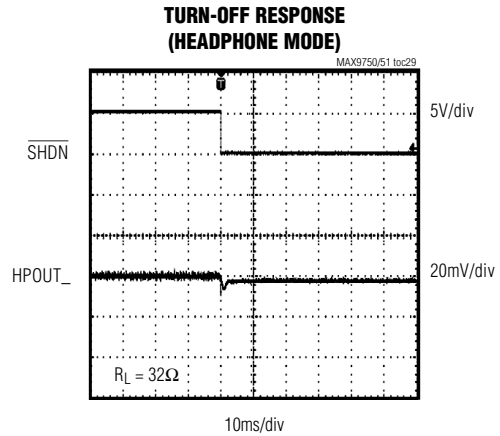
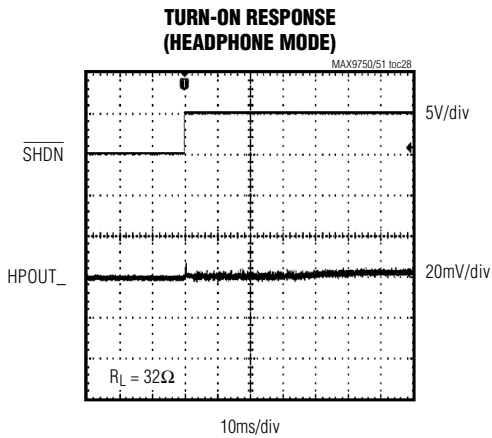
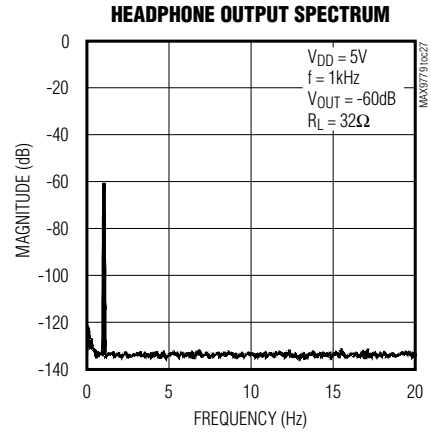
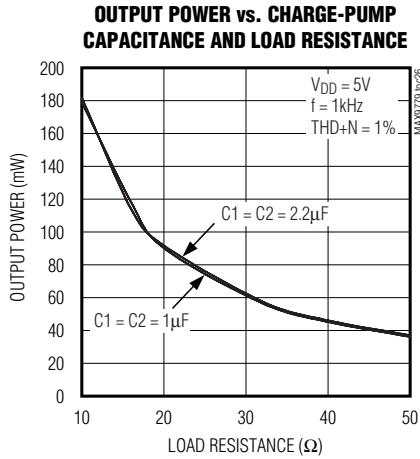

2.6W Stereo Audio Power Amplifier and DirectDrive Headphone Amplifier

Pin Description

MAX9779

PIN	NAME	FUNCTION
1	INL	Left-Channel Audio Input
2	N.C.	No Connection. Not internally connected.
3, 19	PGND	Power Ground
4	OUTL+	Left-Channel Positive Speaker Output
5	OUTL-	Left-Channel Negative Speaker Output
6, 16	PVDD	Speaker Amplifier Power Supply
7	CPVDD	Charge-Pump Power Supply
8	C1P	Charge-Pump Flying-Capacitor Positive Terminal
9	CPGND	Charge-Pump Ground
10	C1N	Charge-Pump Flying-Capacitor Negative Terminal
11	CPVSS	Charge-Pump Output. Connect to VSS.
12	VSS	Headphone Amplifier Negative Power Supply
13	HPOUTR	Right-Channel Headphone Output
14	HPOUTL	Left-Channel Headphone Output
15	HPVDD	Headphone Positive Power Supply
17	OUTR-	Right-Channel Negative Speaker Output
18	OUTR+	Right-Channel Positive Speaker Output
20	HPS	Headphone Sense Input
21	BIAS	Common-Mode Bias Voltage. Bypass with a 1 μ F capacitor to GND.
22	$\overline{\text{SHDN}}$	Shutdown. Drive $\overline{\text{SHDN}}$ low to disable the device. Connect $\overline{\text{SHDN}}$ to VDD for normal operation.
23	GAIN2	Gain Control Input 2
24	GAIN1	Gain Control Input 1
25	VDD	Power Supply
26, 28	GND	Ground
27	INR	Right-Channel Audio Input
EP	EP	Exposed Paddle. Connect EP to GND.

2.6W Stereo Audio Power Amplifier and DirectDrive Headphone Amplifier

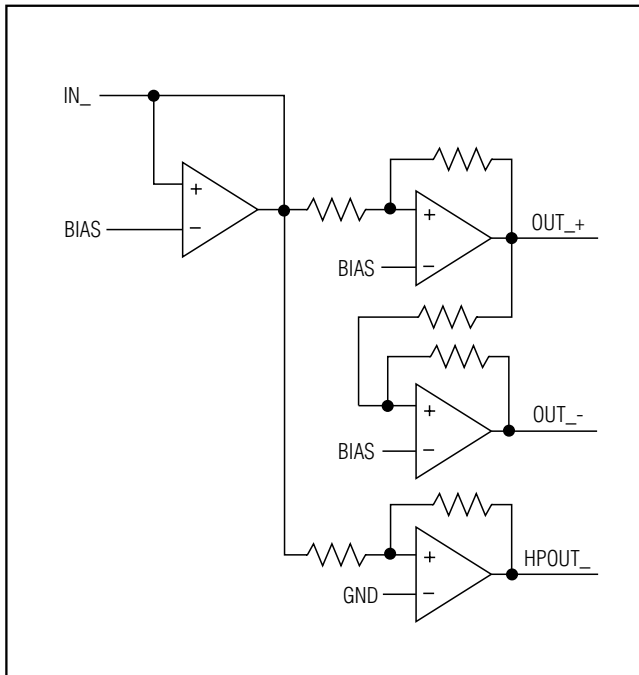

Figure 1. MAX9779 Signal Path

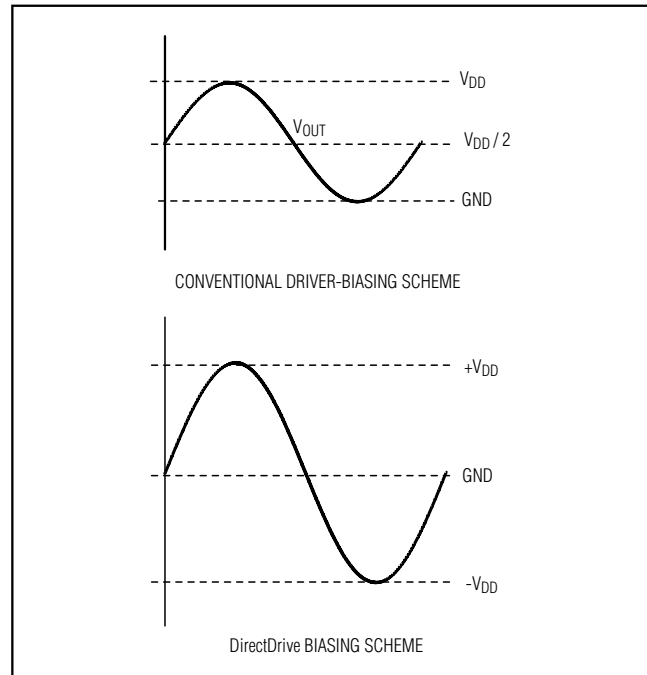

Figure 2. Traditional Headphone Amplifier Output Waveform vs. DirectDrive Headphone Amplifier Output Waveform

Detailed Description

The MAX9779 combines a 2.6W BTL speaker amplifier and a 110mW DirectDrive headphone amplifier with integrated headphone sensing and comprehensive click-and-pop suppression. The MAX9779 features four-level gain control. The device features high 90dB PSRR, low 0.01% THD+N, industry-leading click-pop performance, and a low-power shutdown mode.

Each signal path consists of an input amplifier that sets the gain of the signal path and feeds both the speaker and headphone amplifier (Figure 1). The speaker amplifier uses a BTL architecture, doubling the voltage drive to the speakers and eliminating the need for DC-blocking capacitors. The output consists of two signals, identical in magnitude, but 180° out of phase.

The headphone amplifiers use Maxim's patented DirectDrive architecture that eliminates the bulky output DC-blocking capacitors required by traditional headphone amplifiers. A charge pump inverts the positive supply (CPV_{DD}), creating a negative supply (CPV_{SS}). The headphone amplifiers operate from these bipolar supplies with their outputs biased about GND (Figure 2). The amplifiers have almost twice the supply range compared to other single-supply amplifiers, nearly quadrupling the available output power. The benefit of the

GND bias is that the amplifier outputs no longer have a DC component (typically $V_{DD} / 2$). This eliminates the large DC-blocking capacitors required with conventional headphone amplifiers, conserving board space and system cost, and improving frequency response.

The device features an undervoltage lockout that prevents operation from an insufficient power supply and click-and-pop suppression that eliminates audible transients on startup and shutdown. The amplifiers include thermal-overload and short-circuit protection, and can withstand $\pm 8\text{kV}$ ESD strikes on the headphone amplifier outputs (IEC air discharge). An additional feature of the speaker amplifiers is that there is no phase inversion from input to output.

DirectDrive

Conventional single-supply headphone amplifiers have their outputs biased about a nominal DC voltage (typically half the supply) for maximum dynamic range. Large coupling capacitors are needed to block this DC bias from the headphones. Without these capacitors, a significant amount of DC current flows to the headphone, resulting in unnecessary power dissipation and possible damage to both headphone and headphone amplifier.

Maxim's patented DirectDrive architecture uses a charge pump to create an internal negative supply voltage. This

2.6W Stereo Audio Power Amplifier and DirectDrive Headphone Amplifier

allows the MAX9779 headphone amplifier output to be biased about GND, almost doubling the dynamic range while operating from a single supply. With no DC component, there is no need for the large DC-blocking capacitors. Instead of two large capacitors (220µF typ), the charge pump requires only two small ceramic capacitors (1µF typ), conserving board space, reducing cost, and improving the frequency response of the headphone amplifier. See the Output Power vs. Charge-Pump Capacitance and Load Resistance graph in the *Typical Operating Characteristics* for details of the possible capacitor values.

Previous attempts to eliminate the output-coupling capacitors involved biasing the headphone return (sleeve) to the DC bias voltage of the headphone amplifiers. This method raised some issues:

- 1) The sleeve is typically grounded to the chassis. Using this biasing approach, the sleeve must be isolated from system ground, complicating product design.
- 2) During an ESD strike, the amplifier's ESD structures are the only path to system ground. The amplifier must be able to withstand the full ESD strike.
- 3) When using the headphone jack as a lineout to other equipment, the bias voltage on the sleeve may conflict with the ground potential from other equipment, resulting in large ground-loop current and possible damage to the amplifiers.

Low-Frequency Response

In addition to the cost and size disadvantages, the DC-blocking capacitors limit the low-frequency response of the amplifier and distort the audio signal:

- 1) The impedance of the headphone load to the DC-blocking capacitor forms a highpass filter with the -3dB point determined by:

$$f_{-3dB} = \frac{1}{2\pi R_L C_{OUT}}$$

where R_L is the impedance of the headphone and C_{OUT} is the value of the DC-blocking capacitor.

The highpass filter is required by conventional single-ended, single-supply headphone amplifiers to block the midrail DC component of the audio signal from the headphones. Depending on the -3dB point, the filter can attenuate low-frequency signals within the audio band. Larger values of C_{OUT} reduce the attenuation but are physically larger, more expensive capacitors. Figure 3 shows the relationship between the size of C_{OUT} and the resulting low-frequency attenuation. Note that the -3dB point for a

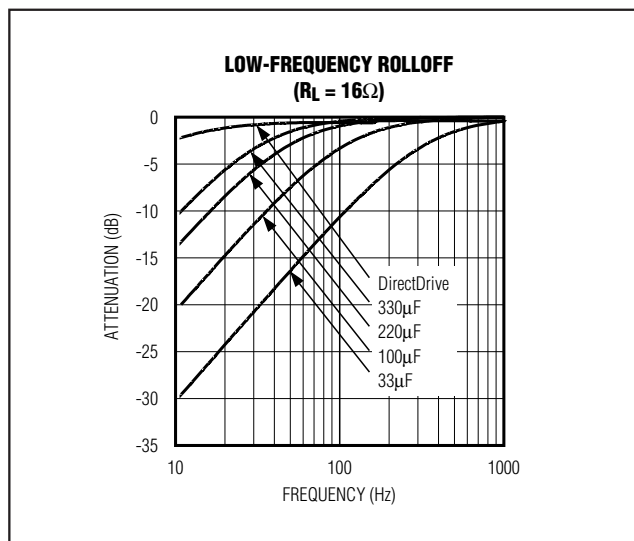

Figure 3. Low-Frequency Attenuation of Common DC-Blocking Capacitor Values

16Ω headphone with a 100µF blocking capacitor is 100Hz, well within the audio band.

- 2) The voltage coefficient of the capacitor, the change in capacitance due to a change in the voltage across the capacitor, distorts the audio signal. At frequencies around the -3dB point, the reactance of the capacitor dominates, and the voltage coefficient appears as frequency-dependent distortion. Figure 4 shows the THD+N introduced by two different capacitor dielectrics. Note that around the -3dB point, THD+N increases dramatically.

The combination of low-frequency attenuation and frequency-dependent distortion compromises audio reproduction. DirectDrive improves low-frequency reproduction in portable audio equipment that emphasizes low-frequency effects such as multimedia laptops, and MP3, CD, and DVD players.

Charge Pump

The MAX9779 features a low-noise charge pump. The 550kHz switching frequency is well beyond the audio range, and does not interfere with the audio signals. The switch drivers feature a controlled switching speed that minimizes noise generated by turn-on and turn-off transients. Limiting the switching speed of the charge pump minimizes the di/dt noise caused by the parasitic bond wire and trace inductance. Although not typically required, additional high-frequency ripple attenuation can be achieved by increasing the size of C_2 (see the *Block Diagram*).

2.6W Stereo Audio Power Amplifier and DirectDrive Headphone Amplifier

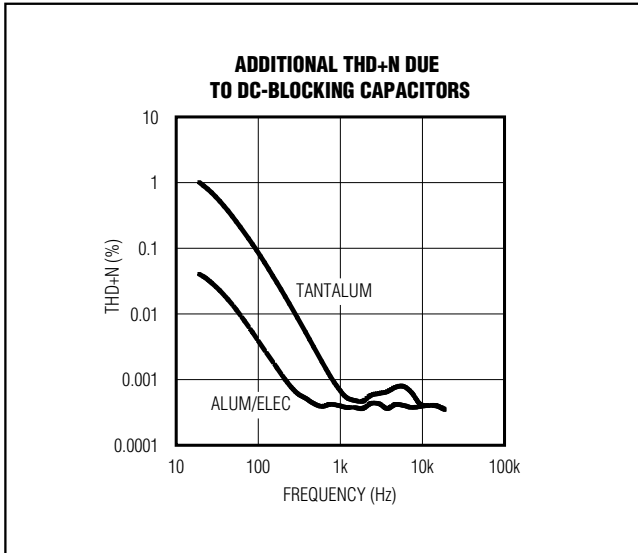

Figure 4. Distortion Contributed by DC-Blocking Capacitors

Headphone Sense Input (HPS)

The headphone sense input (HPS) monitors the headphone jack and automatically configures the device based upon the voltage applied at HPS. A voltage of less than 0.8V sets the device to speaker mode. A voltage of greater than 2V disables the bridge amplifiers and enables the headphone amplifiers.

For automatic headphone detection, connect HPS to the control pin of a 3-wire headphone jack as shown in Figure 5. With no headphone present, the output impedance of the headphone amplifier pulls HPS low. When a headphone plug is inserted into the jack, the control pin is disconnected from the tip contact and HPS is pulled to V_{DD} through a 10 μ A current source.

BIAS

The MAX9779 features an internally generated, power-supply independent, common-mode bias voltage of 1.8V referenced to GND. BIAS provides both click-and-pop suppression and sets the DC bias level for the amplifiers. Choose the value of the bypass capacitor as described in the *BIAS Capacitor* section. No external load should be applied to BIAS. Any load lowers the BIAS voltage, affecting the overall performance of the device.

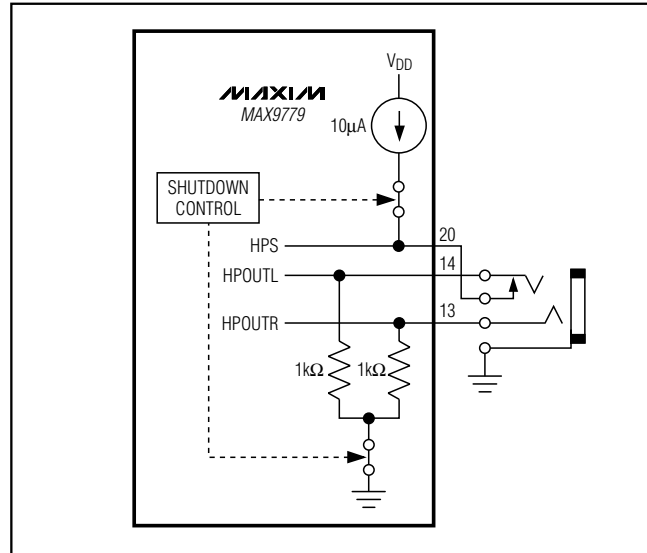

Figure 5. HPS Configuration

Gain Selection

The MAX9779 features an internally set, selectable gain. The GAIN1 and GAIN2 inputs set the maximum gain of the MAX9779 speaker and headphone amplifiers (Table 1).

Shutdown

The MAX9779 features a 0.2 μ A, low-power shutdown mode that reduces quiescent current consumption and extends battery life. Driving $\overline{\text{SHDN}}$ low disables the drive amplifiers, bias circuitry, and charge pump, and drives BIAS and all outputs to GND. Connect $\overline{\text{SHDN}}$ to V_{DD} for normal operation.

Click-and-Pop Suppression

Speaker Amplifier

The MAX9779 speaker amplifiers feature Maxim's comprehensive, industry-leading click-and-pop suppression. During startup, the click-pop suppression circuitry eliminates any audible transient sources internal to the device. When entering shutdown, both amplifier outputs ramp to GND quickly and simultaneously.

2.6W Stereo Audio Power Amplifier and DirectDrive Headphone Amplifier

Table 1. MAX9779 Maximum Gain Settings

GAIN2	GAIN1	SPEAKER-MODE GAIN (dB)	HEADPHONE-MODE GAIN (dB)
0	0	15	0
0	1	16.5	0
1	0	18	3
1	1	19.5	3

Headphone Amplifier

In conventional single-supply headphone amplifiers, the output-coupling capacitor is a major contributor of audible clicks and pops. Upon startup, the amplifier charges the coupling capacitor to its bias voltage, typically half the supply. Likewise, during shutdown, the capacitor is discharged to GND. A DC shift across the capacitor results, which in turn appears as an audible transient at the speaker. Since the MAX9779 does not require output-coupling capacitors, no audible transient occurs.

Additionally, the MAX9779 features extensive click-and-pop suppression that eliminates any audible transient sources internal to the device. The Power-Up/Down Waveform in the *Typical Operating Characteristics* shows that there are minimal spectral components in the audible range at the output upon startup and shutdown.

Applications Information

BTL Speaker Amplifiers

The MAX9779 features speaker amplifiers designed to drive a load differentially, a configuration referred to as bridge-tied load (BTL). The BTL configuration (Figure 6) offers advantages over the single-ended configuration, where one side of the load is connected to ground. Driving the load differentially doubles the output voltage compared to a single-ended amplifier under similar conditions. Thus, the device's differential gain is twice the closed-loop gain of the input amplifier. The effective gain is given by:

$$A_{VD} = 2 \times \frac{R_F}{R_{IN}}$$

Substituting $2 \times V_{OUT(P-P)}$ into the following equation yields four times the output power due to double the output voltage:

$$V_{RMS} = \frac{V_{OUT(P-P)}}{2\sqrt{2}}$$

$$P_{OUT} = \frac{V_{RMS}^2}{R_L}$$

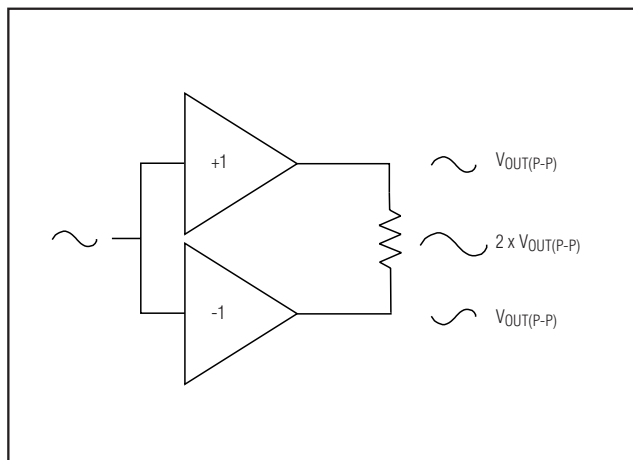

Figure 6. Bridge-Tied Load Configuration

Since the differential outputs are biased at midsupply, there is no net DC voltage across the load. This eliminates the need for DC-blocking capacitors required for single-ended amplifiers. These capacitors can be large and expensive, can consume board space, and can degrade low-frequency performance.

Power Dissipation and Heatsinking

Under normal operating conditions, the MAX9779 can dissipate a significant amount of power. The maximum power dissipation for the TQFN package is given in the *Absolute Maximum Ratings* under Continuous Power Dissipation, or can be calculated by the following equation:

$$P_{DISSPKG(MAX)} = \frac{T_{J(MAX)} - T_A}{\theta_{JA}}$$

where $T_{J(MAX)}$ is $+150^{\circ}\text{C}$, T_A is the ambient temperature, and θ_{JA} is the reciprocal of the derating factor in $^{\circ}\text{C}/\text{W}$ as specified in the *Absolute Maximum Ratings* section. For example, θ_{JA} of the thin QFN package is $+42^{\circ}\text{C}/\text{W}$. For optimum power dissipation, the exposed paddle of the package should be connected to the ground plane (see the *Layout and Grounding* section).

2.6W Stereo Audio Power Amplifier and DirectDrive Headphone Amplifier

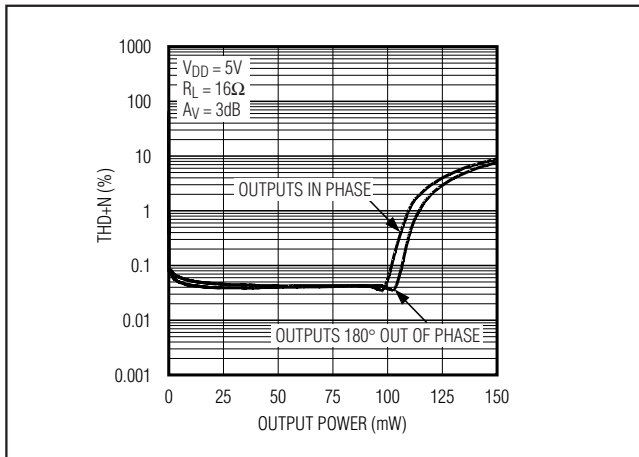

Figure 7. Total Harmonic Distortion Plus Noise vs. Output Power with Inputs In/Out of Phase (Headphone Mode)

For 8Ω applications, the worst-case power dissipation occurs when the output power is 1.1W/channel, resulting in a power dissipation of approximately 1W. In this case, the TQFN package can be used without violating the maximum power dissipation or exceeding the thermal protection threshold. For 4Ω applications, the TQFN package may require heatsinking or forced air cooling to prevent the device from reaching its thermal limit. The more thermally efficient TQFN package is suggested for speaker loads less than 8Ω .

Output Power (Speaker Amplifier)

The increase in power delivered by the BTL configuration directly results in an increase in internal power dissipation over the single-ended configuration. The maximum power dissipation for a given V_{DD} and load is given by the following equation:

$$P_{DISS(MAX)} = \frac{2V_{DD}^2}{\pi^2 R_L}$$

If the power dissipation for a given application exceeds the maximum allowed for a given package, either reduce V_{DD} , increase load impedance, decrease the ambient temperature, or add heatsinking to the device. Large output, supply, and ground PC board traces improve the maximum power dissipation in the package.

Thermal-overload protection limits total power dissipation in these devices. When the junction temperature exceeds $+160^\circ\text{C}$, the thermal-protection circuitry disables the amplifier output stage. The amplifiers are enabled once the junction temperature cools by 15°C . This results in a pulsing output under continuous thermal-overload conditions as the device heats and cools.

Output Power (Headphone Amplifier)

The headphone amplifiers have been specified for the worst-case scenario—when both inputs are in phase. Under this condition, the drivers simultaneously draw current from the charge pump, leading to a slight loss in headroom of V_{SS} . In typical stereo audio applications, the left and right signals have differences in both magnitude and phase, subsequently leading to an increase in the maximum attainable output power. Figure 7 shows the two extreme cases for in and out of phase. In reality, the available power lies between these extremes.

Power Supplies

The MAX9779 has different supplies for each portion of the device, allowing for the optimum combination of headroom, power dissipation, and noise immunity. The speaker amplifiers are powered from PV_{DD} . PV_{DD} ranges from 4.5V to 5.5V. The headphone amplifiers are powered from HPV_{DD} and V_{SS} . HPV_{DD} is the positive supply of the headphone amplifiers and ranges from 3V to 5.5V. V_{SS} is the negative supply of the headphone amplifiers. Connect V_{SS} to CPV_{SS} . The charge pump is powered by CPV_{DD} . CPV_{DD} ranges from 3V to 5.5V and should be the same potential as HPV_{DD} . The charge pump inverts the voltage at CPV_{DD} , and the resulting voltage appears at CPV_{SS} . The remainder of the device is powered by V_{DD} .

Component Selection

Input Filtering

The input capacitor (C_{IN}), in conjunction with the amplifier input resistance (R_{IN}), forms a highpass filter that removes the DC bias from an incoming signal (see the *Block Diagram*). The AC-coupling capacitor allows the amplifier to bias the signal to an optimum DC level. Assuming zero source impedance, the -3dB point of the highpass filter is given by:

$$f_{-3\text{dB}} = \frac{1}{2\pi R_{IN} C_{IN}}$$

R_{IN} is the amplifier's internal input resistance value given in the *Electrical Characteristics*. Choose C_{IN} such that $f_{-3\text{dB}}$ is well below the lowest frequency of interest. Setting $f_{-3\text{dB}}$ too high affects the amplifier's low-frequency response. Use capacitors with low-voltage coefficient dielectrics, such as tantalum or aluminum electrolytic. Capacitors with high-voltage coefficients, such as ceramics, may result in increased distortion at low frequencies.

2.6W Stereo Audio Power Amplifier and DirectDrive Headphone Amplifier

Table 2. Suggested Capacitor Manufacturers

SUPPLIER	PHONE	FAX	WEBSITE
Taiyo Yuden	800-348-2496	847-925-0899	www.t-yuden.com
TDK	807-803-6100	847-390-4405	www.component.tdk.com

BIAS Capacitor

BIAS is the output of the internally generated DC bias voltage. The BIAS bypass capacitor, C_{BIAS}, improves PSRR and THD+N by reducing power supply and other noise sources at the common-mode bias node, and also generates the clickless/popless, startup/shutdown DC bias waveforms for the speaker amplifiers. Bypass BIAS with a 1 μ F capacitor to GND.

Charge-Pump Capacitor Selection

Use capacitors with an ESR less than 100m Ω for optimum performance. Low-ESR ceramic capacitors minimize the output resistance of the charge pump. For best performance over the extended temperature range, select capacitors with an X7R dielectric. Table 4 lists suggested manufacturers.

Flying Capacitor (C1)

The value of the flying capacitor (C1) affects the load regulation and output resistance of the charge pump. A C1 value that is too small degrades the device's ability to provide sufficient current drive, which leads to a loss of output voltage. Increasing the value of C1 improves load regulation and reduces the charge-pump output resistance to an extent. See the Output Power vs. Charge-Pump Capacitance and Load Resistance graph in the *Typical Operating Characteristics*. Above 2.2 μ F, the on-resistance of the switches and the ESR of C1 and C2 dominate.

Output Capacitor (C2)

The output capacitor value and ESR directly affect the ripple at CPV_{SS}. Increasing the value of C2 reduces output ripple. Likewise, decreasing the ESR of C2 reduces both ripple and output resistance. Lower capacitance values can be used in systems with low maximum output power levels. See the Output Power vs. Charge-Pump Capacitance and Load Resistance graph in the *Typical Operating Characteristics*.

CPV_{DD} Bypass Capacitor

The CPV_{DD} bypass capacitor (C3) lowers the output impedance of the power supply and reduces the impact of the MAX9779's charge-pump switching

transients. Bypass CPV_{DD} with C3, the same value as C1, and place it physically close to CPV_{DD} and PGND (refer to the MAX9779 Evaluation Kit for a suggested layout).

Powering Other Circuits from a Negative Supply

An additional benefit of the MAX9779 is the internally generated negative supply voltage (CPV_{SS}). CPV_{SS} is used by the MAX9779 to provide the negative supply for the headphone amplifiers. It can also be used to power other devices within a design. Current draw from CPV_{SS} should be limited to 5mA; exceeding this affects the operation of the headphone amplifier. A typical application is a negative supply to adjust the contrast of LCD modules.

When considering the use of CPV_{SS} in this manner, note that the charge-pump voltage of CPV_{SS} is roughly proportional to CPV_{DD} and is not a regulated voltage. The charge-pump output impedance plot appears in the *Typical Operating Characteristics*.

Layout and Grounding

Proper layout and grounding are essential for optimum performance. Use large traces for the power-supply inputs and amplifier outputs to minimize losses due to parasitic trace resistance, as well as route head away from the device. Good grounding improves audio performance, minimizes crosstalk between channels, and prevents any switching noise from coupling into the audio signal. Connect CPGND, PGND, and GND together at a single point on the PC board. Route CPGND and all traces that carry switching transients away from GND, PGND, and the traces and components in the audio signal path.

Connect all components associated with the charge pump (C2 and C3) to the CPGND plane. Connect V_{SS} and CPV_{SS} together at the device. Place the charge-pump capacitors (C1, C2, and C3) as close to the device as possible. Bypass HPV_{DD} and PV_{DD} with a 0.1 μ F capacitor to GND. Place the bypass capacitors as close to the device as possible.

Use large, low-resistance output traces. As load impedance decreases, the current drawn from the device outputs increase. At higher current, the resistance of the output traces decrease the power delivered to the load.

2.6W Stereo Audio Power Amplifier and DirectDrive Headphone Amplifier

For example, when compared to a 0Ω trace, a 100mΩ trace reduces the power delivered to a 4Ω load from 2.1W to 2W. Large output, supply, and GND traces also improve the power dissipation of the device.

The MAX9779 thin QFN package features an exposed thermal pad on its underside. This pad lowers the package's thermal resistance by providing a direct heat-conduction path from the die to the PC board. Connect the exposed thermal pad to GND by using a large pad and multiple vias to the GND plane.

Block Diagram

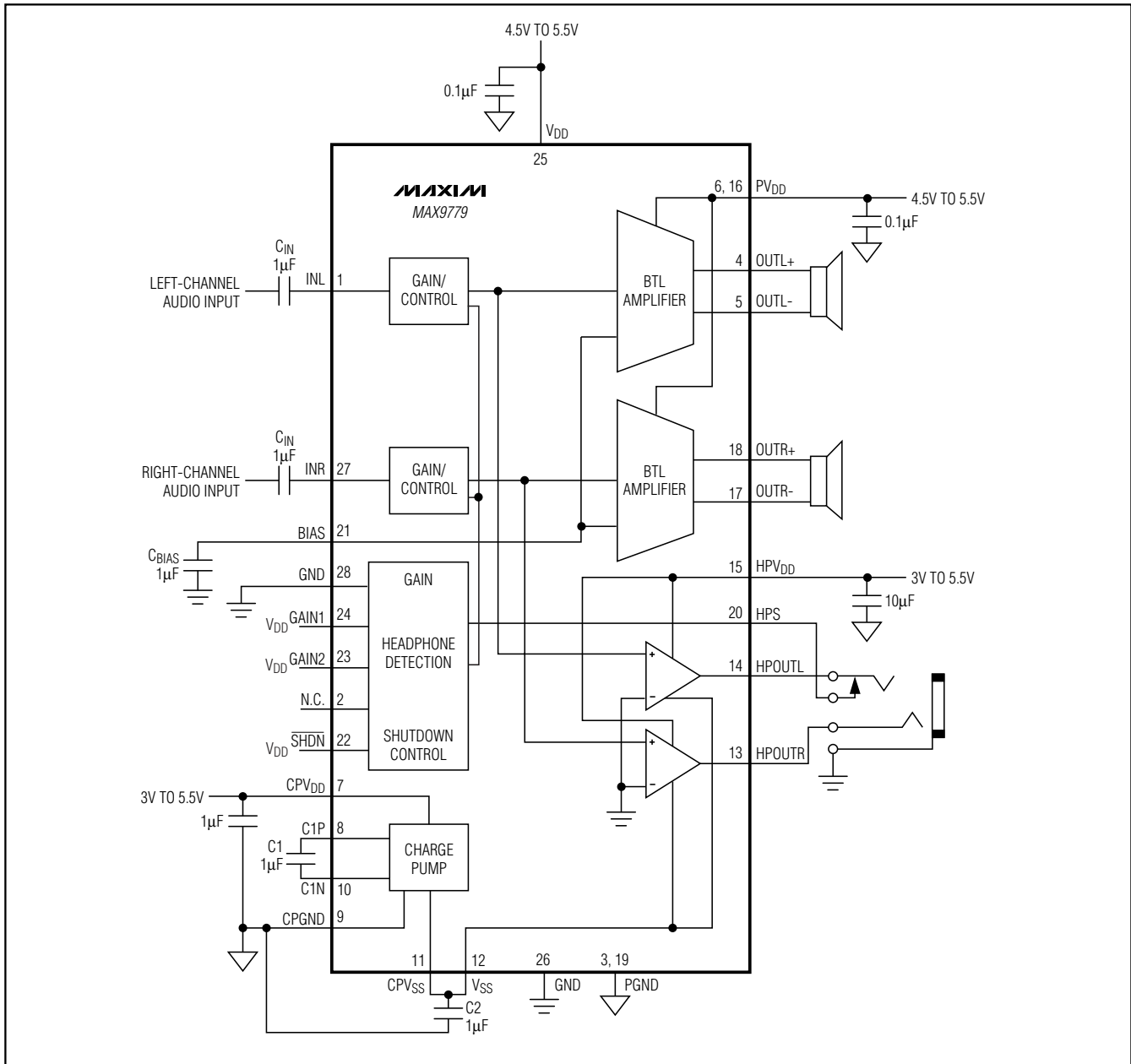

2.6W Stereo Audio Power Amplifier and DirectDrive Headphone Amplifier

Pin Configuration

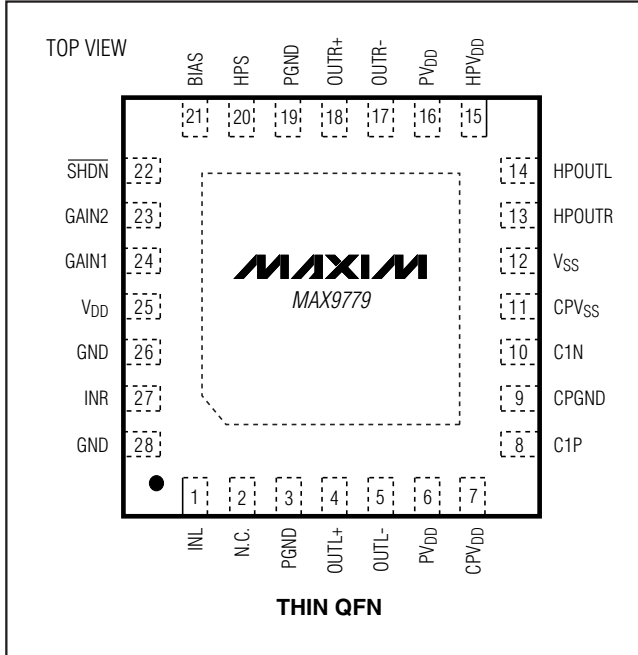

Chip Information

PROCESS: BiCMOS

MAX9779

2.6W Stereo Audio Power Amplifier and DirectDrive Headphone Amplifier

Package Information

(The package drawing(s) in this data sheet may not reflect the most current specifications. For the latest package outline information, go to www.maxim-ic.com/packages.)

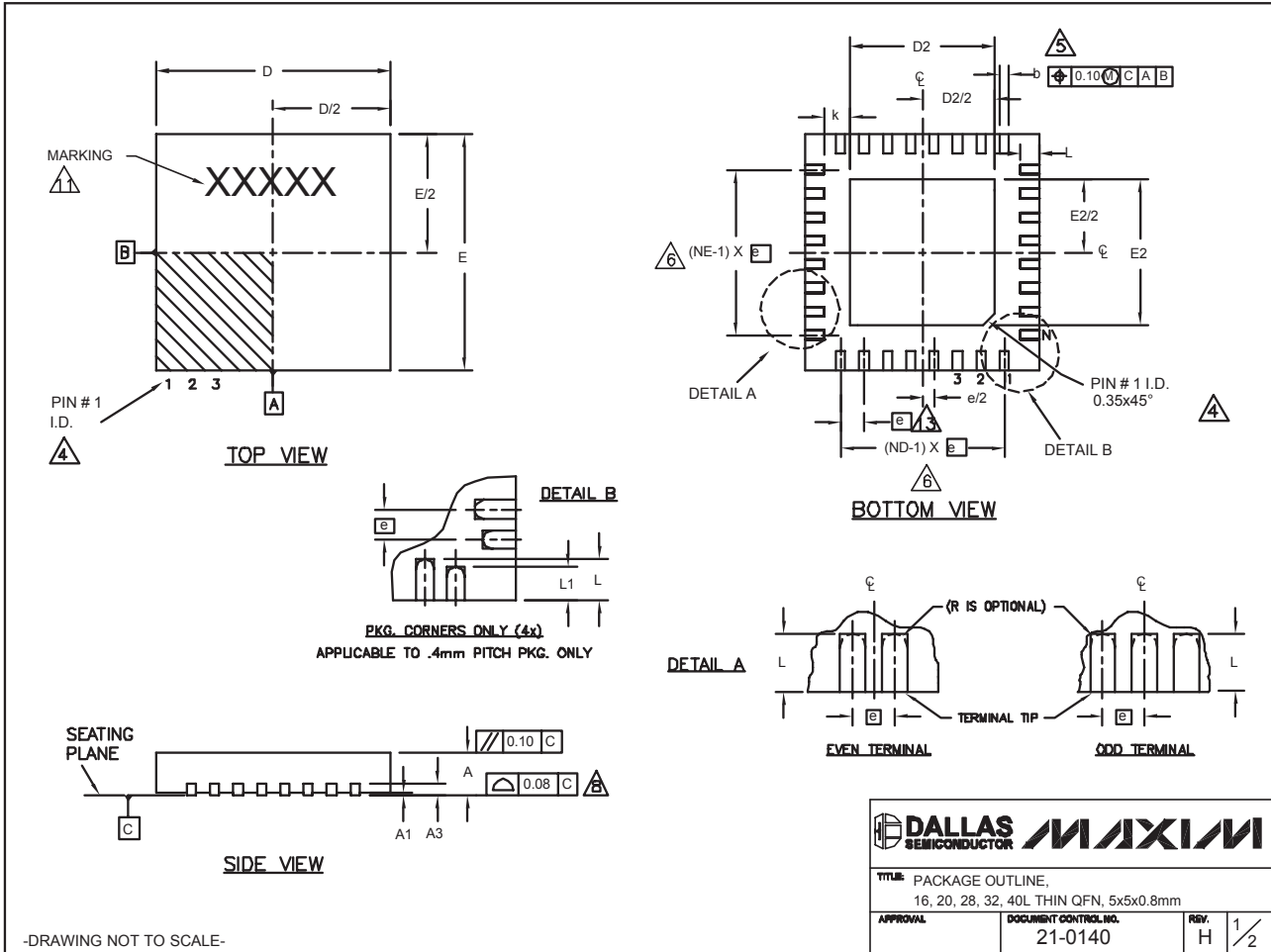

QFN THIN.EPS

TITLE: PACKAGE OUTLINE, 16, 20, 28, 32, 40L THIN QFN, 5x5x0.8mm		
APPROVAL	DOCUMENT CONTROL NO. 21-0140	REV. H 1/2

2.6W Stereo Audio Power Amplifier and DirectDrive Headphone Amplifier

Package Information (continued)

(The package drawing(s) in this data sheet may not reflect the most current specifications. For the latest package outline information, go to www.maxim-ic.com/packages.)

MAX9779

COMMON DIMENSIONS															
PKG.	16L 5x5			20L 5x5			28L 5x5			32L 5x5			40L 5x5		
SYMBOL	MIN.	NOM.	MAX.	MIN.	NOM.	MAX.	MIN.	NOM.	MAX.	MIN.	NOM.	MAX.	MIN.	NOM.	MAX.
A	0.70	0.75	0.80	0.70	0.75	0.80	0.70	0.75	0.80	0.70	0.75	0.80	0.70	0.75	0.80
A1	0	0.02	0.05	0	0.02	0.05	0	0.02	0.05	0	0.02	0.05	0	0.02	0.05
A3	0.20 REF.			0.20 REF.			0.20 REF.			0.20 REF.			0.20 REF.		
b	0.25	0.30	0.35	0.25	0.30	0.35	0.20	0.25	0.30	0.20	0.25	0.30	0.15	0.20	0.25
D	4.90	5.00	5.10	4.90	5.00	5.10	4.90	5.00	5.10	4.90	5.00	5.10	4.90	5.00	5.10
E	4.90	5.00	5.10	4.90	5.00	5.10	4.90	5.00	5.10	4.90	5.00	5.10	4.90	5.00	5.10
e	0.80 BSC.			0.65 BSC.			0.50 BSC.			0.50 BSC.			0.40 BSC.		
k	0.25	-	-	0.25	-	-	0.25	-	-	0.25	-	-	0.25	0.35	0.45
L	0.30	0.40	0.50	0.45	0.55	0.65	0.45	0.55	0.65	0.30	0.40	0.50	0.40	0.50	0.60
L1	-	-	-	-	-	-	-	-	-	-	-	-	0.30	0.40	0.50
N	16			20			28			32			40		
ND	4			5			7			8			10		
NE	4			5			7			8			10		
JEDEC	WHHB			WHHC			WHHD-1			WHHD-2			----		

EXPOSED PAD VARIATIONS									
PKG. CODES	D2			E2			L	DOWN BONDS ALLOWED	
	MIN.	NOM.	MAX.	MIN.	NOM.	MAX.			±0.15
T1655-1	3.00	3.10	3.20	3.00	3.10	3.20	**	NO	
T1655-2	3.00	3.10	3.20	3.00	3.10	3.20	**	YES	
T1655N-1	3.00	3.10	3.20	3.00	3.10	3.20	**	NO	
T2055-2	3.00	3.10	3.20	3.00	3.10	3.20	**	NO	
T2055-3	3.00	3.10	3.20	3.00	3.10	3.20	**	YES	
T2055-4	3.00	3.10	3.20	3.00	3.10	3.20	**	NO	
T2055-5	3.15	3.25	3.35	3.15	3.25	3.35	0.40	YES	
T2855-1	3.15	3.25	3.35	3.15	3.25	3.35	**	NO	
T2855-2	2.60	2.70	2.80	2.60	2.70	2.80	**	NO	
T2855-3	3.15	3.25	3.35	3.15	3.25	3.35	**	YES	
T2855-4	2.60	2.70	2.80	2.60	2.70	2.80	**	YES	
T2855-5	2.60	2.70	2.80	2.60	2.70	2.80	**	NO	
T2855-6	3.15	3.25	3.35	3.15	3.25	3.35	**	NO	
T2855-7	2.60	2.70	2.80	2.60	2.70	2.80	**	YES	
T2855-8	3.15	3.25	3.35	3.15	3.25	3.35	0.40	YES	
T2855N-1	3.15	3.25	3.35	3.15	3.25	3.35	**	NO	
T3255-2	3.00	3.10	3.20	3.00	3.10	3.20	**	NO	
T3255-3	3.00	3.10	3.20	3.00	3.10	3.20	**	YES	
T3255-4	3.00	3.10	3.20	3.00	3.10	3.20	**	NO	
T3255N-1	3.00	3.10	3.20	3.00	3.10	3.20	**	NO	
T4055-1	3.20	3.30	3.40	3.20	3.30	3.40	**	YES	

** SEE COMMON DIMENSIONS TABLE

NOTES:

1. DIMENSIONING & TOLERANCING CONFORM TO ASME Y14.5M-1994.
2. ALL DIMENSIONS ARE IN MILLIMETERS. ANGLES ARE IN DEGREES.
3. N IS THE TOTAL NUMBER OF TERMINALS.
4. THE TERMINAL #1 IDENTIFIER AND TERMINAL NUMBERING CONVENTION SHALL CONFORM TO JESD 95-1 SPP-012. DETAILS OF TERMINAL #1 IDENTIFIER ARE OPTIONAL, BUT MUST BE LOCATED WITHIN THE ZONE INDICATED. THE TERMINAL #1 IDENTIFIER MAY BE EITHER A MOLD OR MARKED FEATURE.
5. DIMENSION b APPLIES TO METALLIZED TERMINAL AND IS MEASURED BETWEEN 0.25 mm AND 0.30 mm FROM TERMINAL TIP.
6. ND AND NE REFER TO THE NUMBER OF TERMINALS ON EACH D AND E SIDE RESPECTIVELY.
7. DEPOPULATION IS POSSIBLE IN A SYMMETRICAL FASHION.
8. COPLANARITY APPLIES TO THE EXPOSED HEAT SINK SLUG AS WELL AS THE TERMINALS.
9. DRAWING CONFORMS TO JEDEC MO220, EXCEPT EXPOSED PAD DIMENSION FOR T2855-1, T2855-3, AND T2855-6.
10. WARPAGE SHALL NOT EXCEED 0.10 mm.
11. MARKING IS FOR PACKAGE ORIENTATION REFERENCE ONLY.
12. NUMBER OF LEADS SHOWN ARE FOR REFERENCE ONLY.
13. LEAD CENTERLINES TO BE AT TRUE POSITION AS DEFINED BY BASIC DIMENSION "e", ±0.05.

-DRAWING NOT TO SCALE-

		
TITLE: PACKAGE OUTLINE, 16, 20, 28, 32, 40L THIN QFN, 5x5x0.8mm		
APPROVAL	DOCUMENT CONTROLING	REV.
	21-0140	H 2/2

Maxim cannot assume responsibility for use of any circuitry other than circuitry entirely embodied in a Maxim product. No circuit patent licenses are implied. Maxim reserves the right to change the circuitry and specifications without notice at any time.

Maxim Integrated Products, 120 San Gabriel Drive, Sunnyvale, CA 94086 408-737-7600 19