

Series 79 Micro-Crimp Section G: Right Angle Printed Circuit Board Connectors

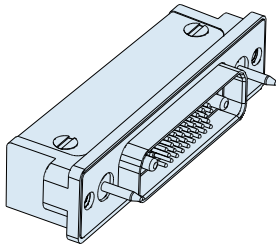

PANEL RECEPTACLES WITH PIN CONTACTS, RIGHT ANGLE PCB TERMINATION, 790-036P

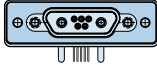
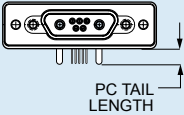
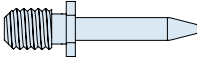
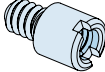
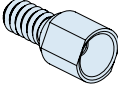

Lightweight, rugged right angle headers feature gold-plated contacts for thru-hole printed circuit board termination. 790-036P connectors are designed for rear-panel mounting and are supplied with conductive panel gaskets. Contacts are permanently installed and are sealed with epoxy. Shells are aluminum alloy. Threaded board mounting holes and integral standoffs simplify installation. EMI shroud improves EMI performance. Fluorosilicone face seal provides watertight interface. Available in 29 different contact arrangements, these connectors feature size #23 signal contacts along with #16 and #12 power contacts for up to 23 amps current rating.

HOW TO ORDER				
Sample Part Number				
790-036P	D-7P2	MT	P	A
Part Number	Shell Size - Insert Arr.	Shell Finish	Hardware Option	PC Tail Length
790-036P Rear-Panel Mounted Receptacle with 90° PC Tail Pin Contacts for Termination to Backplanes or Flexible Circuits	See Table 1 for Available Insert Arrangements	M Electroless Nickel <i>general purpose applications</i>	 N No Hardware	A .125 Inch (3.2 mm.) B .250 inch (6.4 mm.)  PC TAIL LENGTH
		MT Nickel-PTFE 1000 Hour Grey™ <i>maximum corrosion protection and durability (non-reflective grey)</i>	 G Guide Pin	
		ZNU Zinc-Nickel with Black Chromate <i>tactical applications (non-reflective black)</i>	 P Female Jackpost	
		Additional shell finishes are listed on page C-9.	 S Female Guide Socket	

SPECIFICATIONS	
Current Rating	#23 5 AMPS, #16 13 A., #12 23 A.
Dielectric Withstanding Voltage	#23 500 VAC RMS, #12 and #16 1800 VAC RMS
Insulation Resistance	5000 megohms minimum
Operating Temperature	-65° C. to +150° C.
Shock	300 g.
Vibration	37 g.

MATERIALS AND FINISHES	
Shell	Aluminum alloy
Contacts	Copper alloy, 50 microinches gold plated
Insulator	Liquid crystal polymer (LCP)
Interfacial Seal	Fluorosilicone rubber
Hardware	300 series stainless steel
Panel Gasket	Fluorosilicone, conductive
Encapsulant	Epoxy

Dimensions in inches (millimeters) and are subject to change without notice.

Table 1
Contact Arrangements

Layout	Contact Quantity			Face View
	#23	#16	#12	
A-5	5			
B-2P2		2		
B-9	9			
C-13	13			
D-15	15			
D-3P3		3		
D-7P2	5	2		
E-11P2	9	2		
E-19	19			
E-7P3	4	3		
F-15P2	13	2		
F-23	23			
F-5P5		5		
G-33	33			
H-10P4	6	4		
H-29P7	22	7		
H-36P2	34	2		
H-54P2	52	2		
H-5P5		5		
H-66	66			
J-17P4	13	4		
J-25P2	23	2		
J-33	33			
J-7P7		7		
K-27P4	23	4		
K-35P2	33	2		
K-43	43			
K-9P9		9		
L-6P6			6	

CROSS-SECTIONAL VIEW OF 790-036P

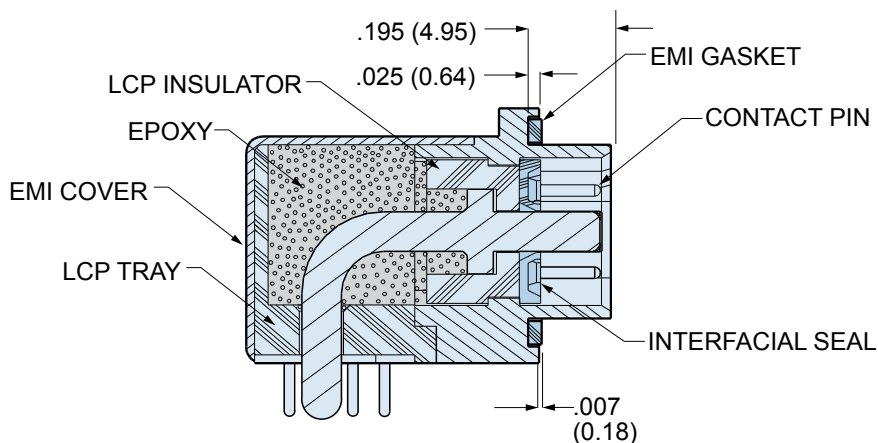
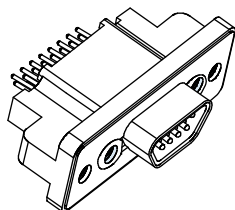
TABLE 2
HARDWARE OPTION**N****No Mating Hardware**

Connector is supplied with blind, tapped holes. Shell sizes H and L have 6-32 UNC-2B thread, other sizes are #4-40. Minimum thread depth is .150" (3.81).

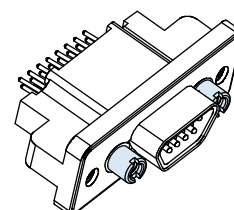
**P****Jackposts**

Connector is supplied with non-removable jackposts. Shell sizes H and L have #4-40 UNC-2B thread, other sizes have #2-56 thread.

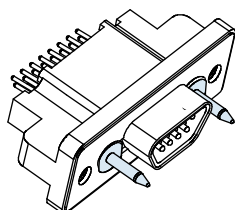
**G****Male Guide Pins**

Connector is supplied with stainless steel guide pins to mate with code S guide sockets. Pins are non-removable.

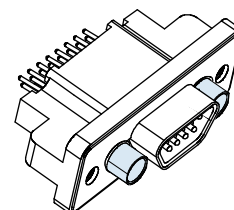
**S****Female Guide Sockets**

Connector is supplied with stainless steel guide sockets to mate with code G guide pins. Sockets are non-removable.

Dimensions in inches (millimeters) and are subject to change without notice.

CAGE Code 06324

Printed in U.S.A.

© 2009 Glenair, Inc.

GLENAIR, INC. • 1211 AIR WAY • GLENDALE, CA 91201-2497 • 818-247-6000 • FAX 818-500-9912

www.glenair.com

G-2

E-Mail: sales@glenair.com

Rev. 04-July-2009

Series 79 Micro-Crimp Section G: Right Angle Printed Circuit Board Connectors



790-036P DIMENSIONS: SHELL SIZES A-F, J, AND K

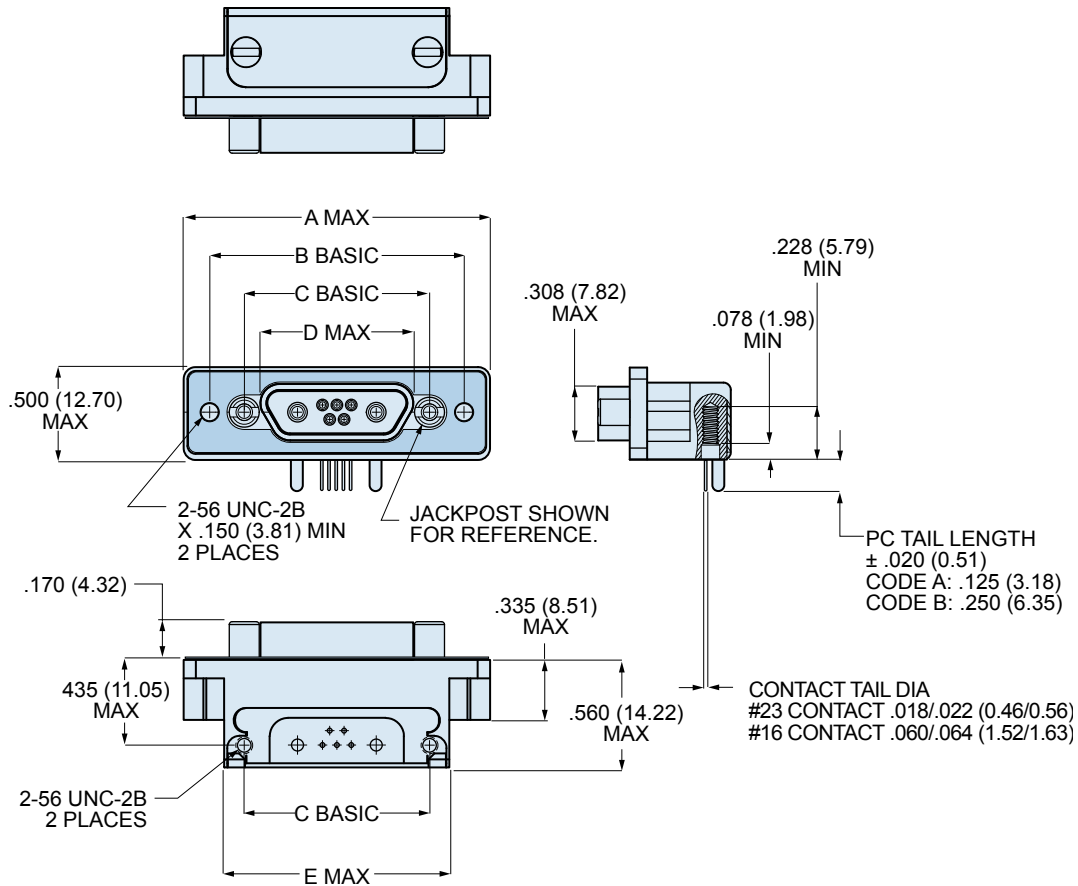

790-036P SHELL SIZES A-F, J AND K

Shell Size	A Max.		B Basic		C Basic		D Max.		E Max.	
	In.	mm.	In.	mm.	In.	mm.	In.	mm.	In.	mm.
A	1.211	30.76	.925	23.50	.565	14.35	.401	10.19	.760	19.30
B	1.361	34.57	1.075	27.31	.715	18.16	.551	14.00	.910	21.11
C	1.511	38.38	1.225	31.12	.865	21.97	.701	17.81	1.060	26.92
D	1.611	40.92	1.325	33.66	.965	24.51	.801	20.35	1.160	29.46
E	1.761	44.73	1.475	37.47	1.115	28.32	.951	24.16	1.310	33.27
F	1.911	48.54	1.625	41.28	1.265	32.13	1.101	27.96	1.460	37.08
J	2.261	57.43	1.975	50.17	1.615	41.02	1.460	37.08	1.810	45.97
K	2.661	67.59	2.375	60.33	2.015	51.18	1.860	47.24	2.210	56.13

Dimensions in inches (millimeters) and are subject to change without notice.

790-036P DIMENSIONS: SHELL SIZE G

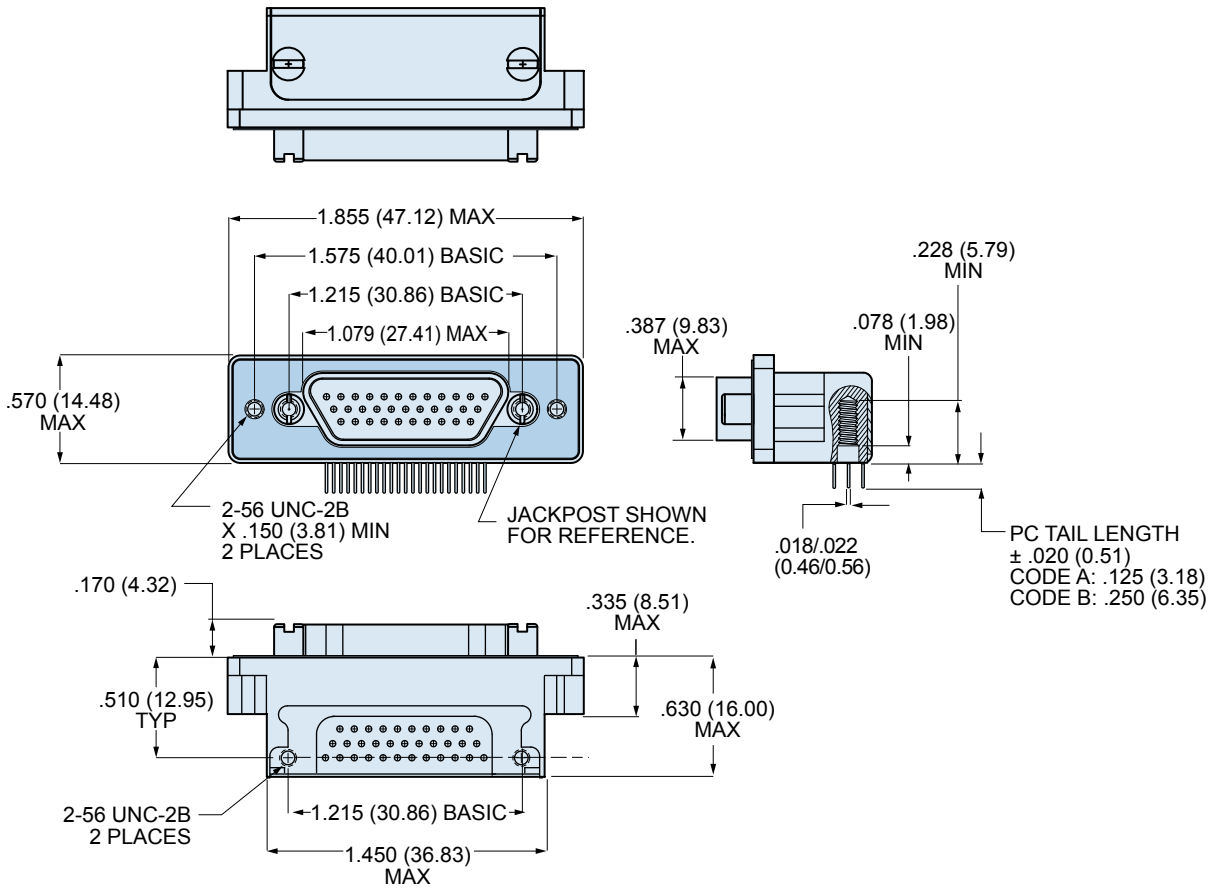

Dimensions in inches (millimeters) and are subject to change without notice.

Series 79 Micro-Crimp Section G: Right Angle Printed Circuit Board Connectors



790-036P DIMENSIONS: SHELL SIZE H AND L

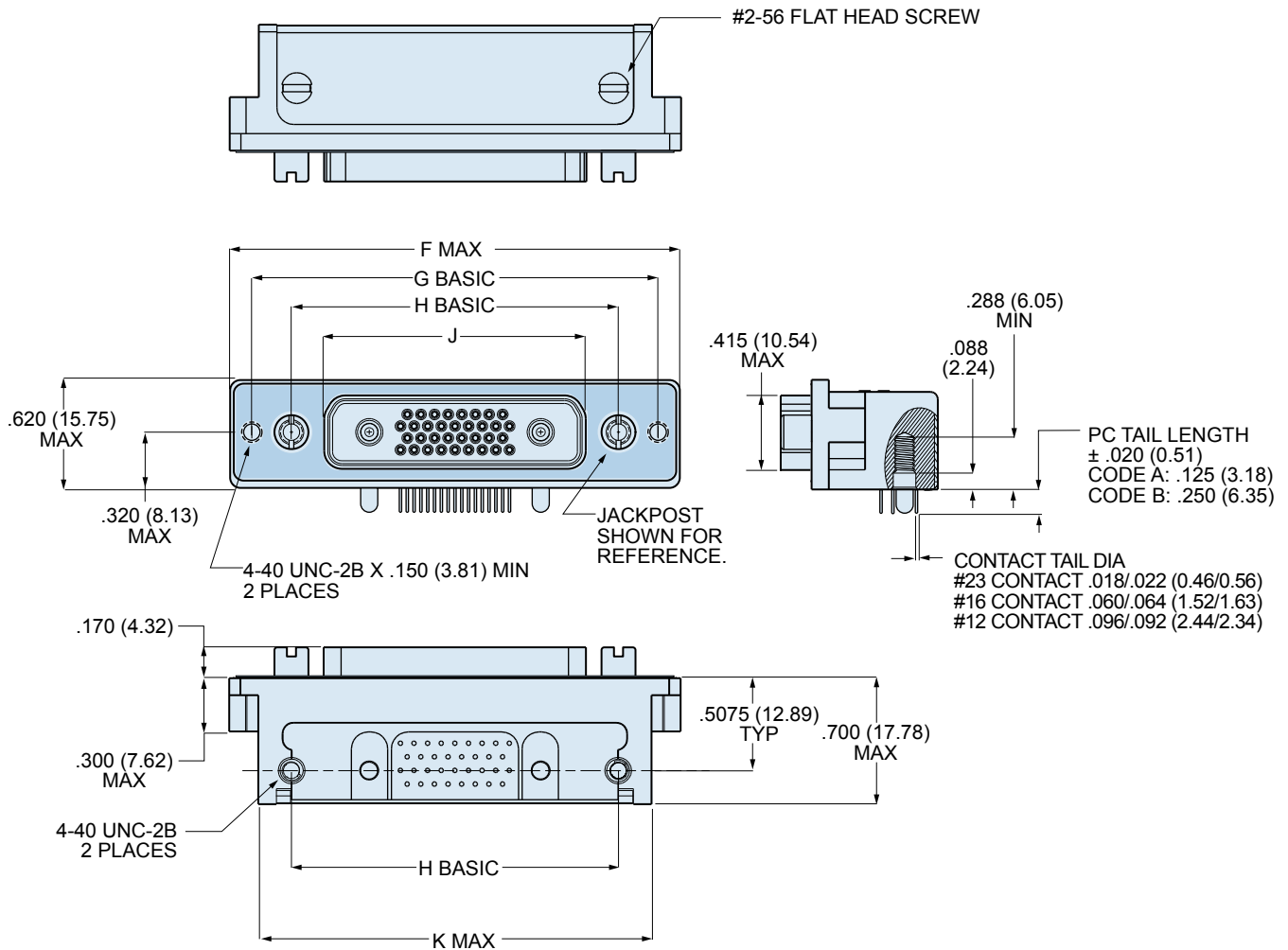

790-036P SHELL SIZES H AND L

Shell Size	F Max.		G Basic		H Basic		J Max.		K Max.	
	In.	mm.	In.	mm.	In.	mm.	In.	mm.	In.	mm.
H	2.500	63.50	2.236	56.79	1.800	45.72	1.450	36.83	2.045	51.94
L	2.736	69.49	2.472	62.79	2.036	51.71	1.686	42.82	2.281	57.94

Dimensions in inches (millimeters) and are subject to change without notice.

PCB Hole Patterns for 790-036P and 790-041P Receptacles

This section contains printed circuit board footprints for right angle Series 79 receptacles. The contact identification numbers are shown for the connector mounting side of the PC board. Contact tails are gold over nickel plated.

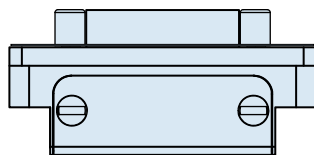

CONNECTOR ORIENTATION

Contact Size	PC Tail Diameter	
	In.	mm.
#23	.018-.022	0.46-0.56
#16	.060-.064	1.52-1.63
#12	.092-.096	2.34-2.44

790-036P AND 790-041P PRINTED CIRCUIT BOARD PATTERNS

Insert Arr.	Component Mounting Side of PCB Mating Face of Connector is Toward Top of Page
A-5	
B-2P2	
B-9	
C-13	

Dimensions in inches (millimeters) and are subject to change without notice.

Series 79 Micro-Crimp Section G: Right Angle Printed Circuit Board Connectors



790-036P AND 790-041P PRINTED CIRCUIT BOARD PATTERNS

Insert Arr.	Component Mounting Side of PCB Mating Face of Connector is Toward Top of Page
D-15	
D-3P3	
D-7P2	
E-11P2	
E-19	

Dimensions in inches (millimeters) and are subject to change without notice.

790-036P AND 790-041P PRINTED CIRCUIT BOARD PATTERNS

Insert Arr.	Component Mounting Side of PCB Mating Face of Connector is Toward Top of Page
E-7P3	
F-15P2	
F-23	
F-5P5	
G-33	

Dimensions in inches (millimeters) and are subject to change without notice.

Series 79 Micro-Crimp Section G: Right Angle Printed Circuit Board Connectors



790-036P AND 790-041P PRINTED CIRCUIT BOARD PATTERNS

Insert Arr.	Component Mounting Side of PCB Mating Face of Connector is Toward Top of Page
H-10P4	
H-29P7	
H-36P2	
H-54P2	
H-5P5	

Dimensions in inches (millimeters) and are subject to change without notice.

790-036P AND 790-041P PRINTED CIRCUIT BOARD PATTERNS

Insert Arr.	Component Mounting Side of PCB Mating Face of Connector is Toward Top of Page
H-66	
J-17P4	
J-25P2	
J-33	
J-7P7	

Dimensions in inches (millimeters) and are subject to change without notice.

Series 79 Micro-Crimp Section G: Right Angle Printed Circuit Board Connectors



790-036P AND 790-041P PRINTED CIRCUIT BOARD PATTERNS

Insert Arr.	Component Mounting Side of PCB Mating Face of Connector is Toward Top of Page
K-27P4	
K-35P2	
K-43	
K-9P9	
L-6P6	

Dimensions in inches (millimeters) and are subject to change without notice.