

CSDX Series

Digital pressure transducers

FEATURES

- 0...25 mbar to 0...5 bar,
0...±10 mbar to 0...±1 bar,
barometric range 800...1100 mbar
- Absolute, gage or differential pressure
- Digital readout via I²C-bus
- Precision ASIC conditioning
- Temperature compensated
- Non-ratiometric output
- Total accuracy ±0.5 to ±1.0 %FSS

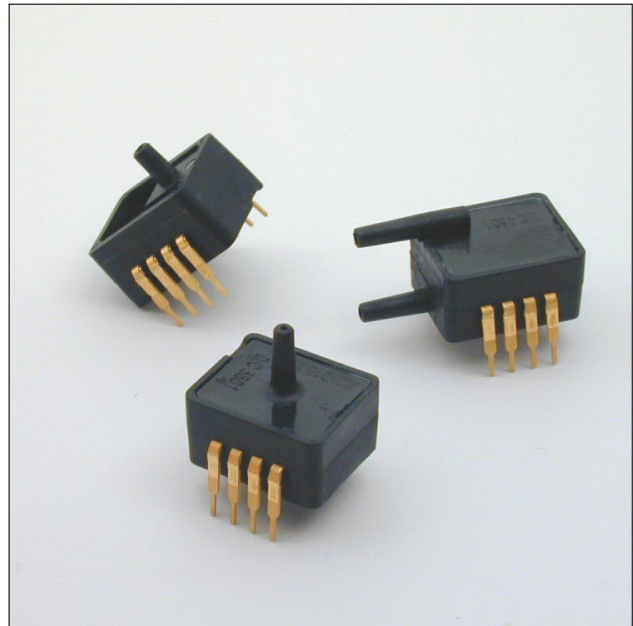

SPECIFICATIONS

Maximum ratings

Supply voltage V_s	4.75 V to 5.25 V_{DC} max. 6.50 V_{DC}
Lead temperature (2 - 4 sec.)	250°C
Temperature ranges	
Compensated	0 to +85°C
Operating	-20 to +105°C
Storage	-40 to +125°C
Vibration	10 g at 20 - 2000 Hz
Shock	100 g for 11 ms

Caution! The sensor is not reverse polarity protected.

Incorrect applications of excitation voltage or ground to the wrong pin can cause electrical failure.

Application of supply voltage above the maximum can cause electrical failure.

ELECTRICAL CONNECTION

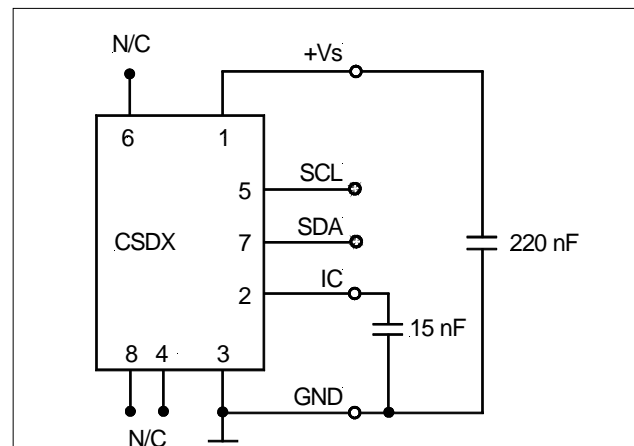

Note: A capacitor of 220 nF is required between +Vs and GND.

Pin 2 is an internal device connection and should be connected to ground with a 15 nF capacitor.

It is important to place the capacitors as close to the pins as possible!

Pins 4, 6 and 8 are internal device connections and should not be connected for any reason!

CSDX Series

Digital pressure transducers

PRESSURE RANGES SPECIFICATIONS

($V_s = 5.0 V_{DC}$, $T_A = 25^\circ C$)

Part number	Pressure range		Burst pressure ¹		Sensitivity (typ.)	
CSDX0811BARO	800 to 1100	mbar(a)	2	bar (a)	10.7	counts/ mbar
CSDX1000A2R	0 to 1	bar (a)	2		3.2	
CSDX2000A2R	0 to 2		4		1.6	
CSDX5000A2R	0 to 5		10		0.6	
CSDX0025D4R	0 to 25	mbar (g,d)	0.2	bar (g,d)	128	
CSDX0050G2R / D4R	0 to 50		0.35		64	
CSDX0100G2R / D4R	0 to 100		0.35		32	
CSDX0250G2R / D4R	0 to 250		1		12.8	
CSDX0500G2R / D4R	0 to 500		1		6.4	
CSDX1000G2R / D4R	0 to 1	bar (g,d)	2		3.2	
CSDX2000G2R / D4R	0 to 2		4		1.6	
CSDX5000G2R / D4R	0 to 5		10		0.6	
CSDX0010D4D	0 to ± 10	mbar (d)	0.2	bar (d)	160	
CSDX0025D4D	0 to ± 25		0.2		64	
CSDX0050D4D	0 to ± 50		0.35		32	
CSDX0100D4D	0 to ± 100		0.35		16	
CSDX0250D4D	0 to ± 250		1		6.4	
CSDX0500D4D	0 to ± 500		1		3.2	
CSDX1000D4D	0 to ± 1		bar(d)		2	

Specification notes:

1. If maximum burst pressure is exceeded, even momentarily, the package may leak or burst, or the pressure sensing die may fracture.
2. Span is the algebraic difference between the output signal for the highest and lowest specified pressure.
3. Total accuracy is the combined error from offset and span calibration, linearity, pressure hysteresis, and temperature effects. Linearity is the measured deviation based on a straight line. Hysteresis is the maximum output difference at any point within the operating pressure range for increasing and decreasing pressure. Calibration errors include the deviation of offset and full scale from nominal values.
4. Delay time between sampling and signal change at the output.
5. The smallest change in the output voltage, given any change in pressure.

CSDX Series

Digital pressure transducers

PERFORMANCE CHARACTERISTICS

The output signal is not ratiometric to the supply voltage ($V_S = 5.0 V_{DC}$, $T_A = 25^\circ C$)

All CSDX...R and CSDX0811BARO

Characteristics		Min.	Typ.	Max.	Units
Offset at lowest specified pressure	CSDX0025... CSDX0050... CSDX0811BARO	368	400	432	counts
	all others	384	400	416	
Full scale span (FSS) ²			3200		
Full scale output	CSDX0025... CSDX0050... CSDX0811BARO	3568	3600	3632	counts
	all others	3584	3600	3616	
Total accuracy (0 to 85°C) ³	CSDX0025... CSDX0050... CSDX0811BARO			±1.0	%FSS
	all others			±0.5	
Sample rate		100			Hz
Response delay ⁴		2.73		14.11	ms
Startup time (power up to 1st result)				40	
Quantization step ⁵	CSDX0811BARO		4		counts
	all others		2		
Current consumption			6		mA

All CSDX...D

Characteristics		Min.	Typ.	Max.	Units	
Zero pressure offset	CSDX0010... CSDX0025... CSDX0050...	1968	2000	2032	counts	
	all others	1984	2000	2016		
Full scale span (FSS) ²			3200			
Output	at max. specified pressure	CSDX0010... CSDX0025... CSDX0050...	3568	3600	3632	counts
		all others	3584	3600	3616	
	at min. specified pressure	CSDX0010... CSDX0025... CSDX0050...	368	400	432	
		all others	384	400	416	
Total accuracy (0 to 85°C) ³	CSDX0010... CSDX0025... CSDX0050...			±1.0	%FSS	
	all others			±0.5		
Sample rate		100			Hz	
Response delay ⁴		2.73		14.11	ms	
Startup time (power up to 1st result)				40		
Quantization step ⁵			2		counts	
Current consumption			6		mA	

INTRODUCTION

The CSDX is capable to generate a digital output signal. It runs a cyclic program, which will store a corrected 12-bit sensor value about every 10 ms within the output registers of the internal ASIC. In order to use the pressure transducer for digital signal readout, the device should be connected to a bidirectional I²C-bus.

According to the I²C-bus communication specification, the bus is controlled by a master device, which generates the clock signal, controls the bus access and generates START and STOP conditions. The CSDX is designed to work as a slave, hence it will only respond to requests from a master device.

The I²C-bus master-slave concept requires a unique address for each device. The CSDX has a hard coded slave address (1111000xb), therefore it is **not** possible to access more than one CSDX on the same I²C-bus line.

DIGITAL I²C INTERFACE

The CSDX complies with the following protocol (FIGURE I):

Bus not busy: During idle periods both data line (SDA) and clock line (SCL) remain HIGH.

START condition (S): HIGH to LOW transition of SDA line while clock (SCL) is HIGH is interpreted as START condition. START conditions are always generated by the master. Each request for the current pressure value must be initiated with a START.

STOP condition (P): LOW to HIGH transition of SDA line while clock (SCL) is HIGH determines STOP condition. STOP conditions are always generated by the master. More than one request for the current pressure value can be transmitted without generation of intermediate STOP condition.

DATA valid (D): State of data line represents valid data when, after START condition, data line is stable for duration of HIGH period of clock signal. Data on line must be changed during LOW period of clock signal. There is one clock pulse per bit of data.

Acknowledge (A): Data is transferred in pieces of 8 bits (1 byte) on serial bus, MSB first. After each byte receiving device – whether master or slave – is obliged to pull data line LOW as acknowledge for reception of data. Master must generate an extra clock pulse for this purpose. When acknowledge is missed, slave transmitter becomes inactive. It is on master either to send last command again or to generate STOP condition in that case.

Slave address: Each device connected to the bus has a unique slave address. After generating a START condition, the master has to transmit the slave address for the CSDX with a READ command: \$F1. The CSDX must not be accessed with a WRITE command (\$F0) as the correct function of the device can not be guaranteed in this case (note: a power-down power-up change will force the sensor to use factory data again).

DATA operation: The CSDX starts to send 2 data bytes containing the current pressure value placed in the output registers.

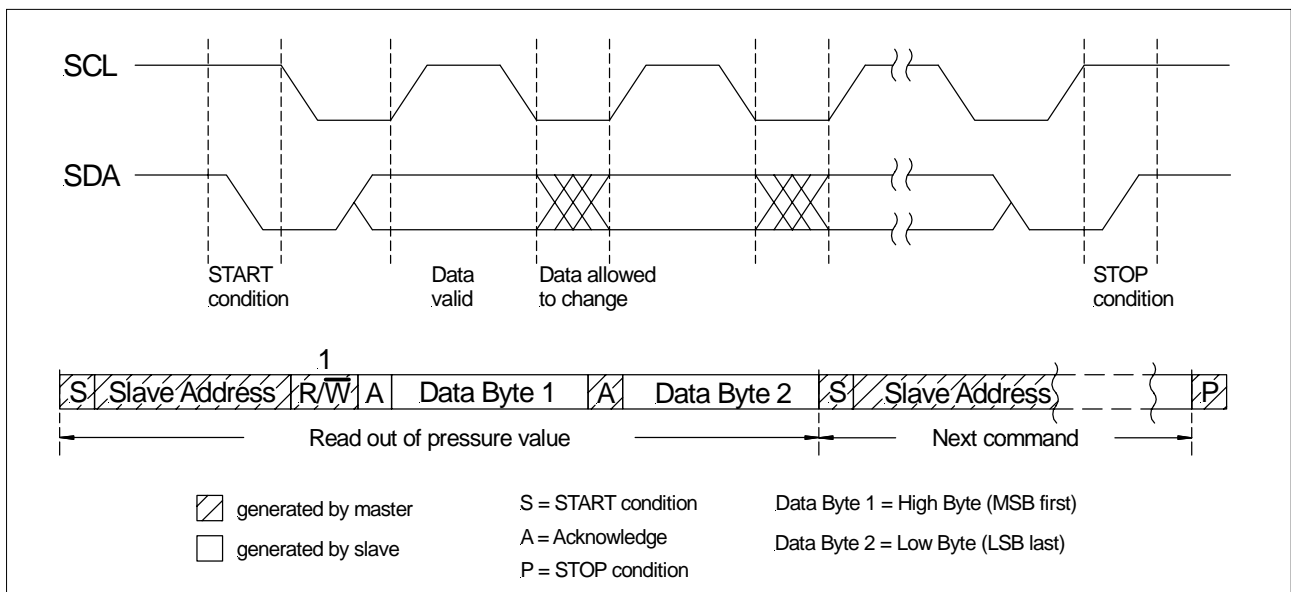

FIGURE I: I²C-BUS Protocol of CSDX

I²C INTERFACE PARAMETERS

Parameter	Symbol	Conditions	Min.	Typ.	Max.	Unit
Input high level			90		100	% of Vs
Input low level			0		10	
Output low level		(open drain, IOL = -4 mA)			10	
Pull up current		(pins SCL and SDA)	5		20	μA
Load capacitance SDA					400	pF
SCL clock frequency	F _{SCL}		---		100	kHz
Bus free time between STOP and START condition	t _{BUF}		4.7			μs
Hold time (repeated) START condition	t _{HD;STA}	to first clock pulse	4.0			μs
LOW period of SCL	t _{LOW}		4.7			μs
HIGH period of SCL	t _{HIGH}		4.0			μs
Setup time repeated START condition	t _{SU;STA}		4.7			μs
Data hold time	t _{HD;DAT}		0			ns
Data setup time	t _{SU;DAT}		250			ns
Rise time of both SDA and SCL	t _R		---		300	ns
Fall time of both SDA and SCL	t _F		---		300	ns
Setup time for STOP condition	t _{SU;STO}		4			μs
Input filter spike suppression	t _{SP}	spikes on SDA or SCL of that length are suppressed			50	ns

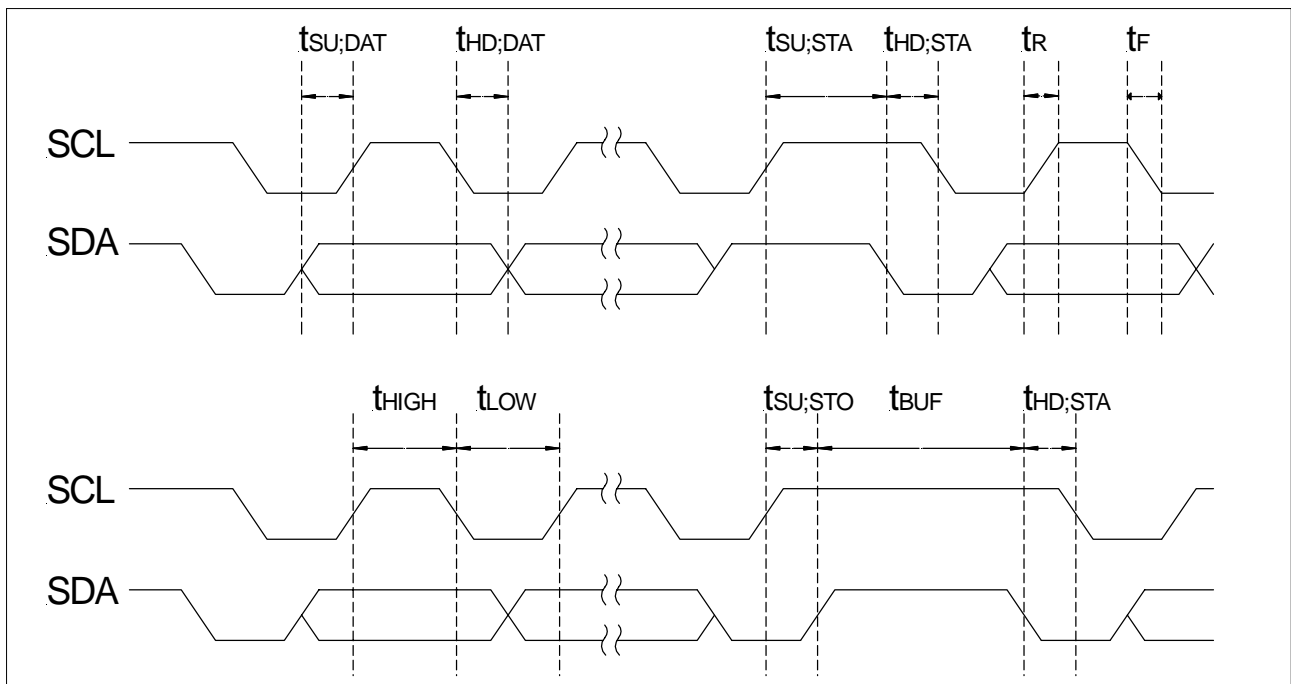

FIGURE II: Timing characteristics of the I²C interface

CSDX Series

Digital pressure transducers

PHYSICAL DIMENSIONS

D4 package

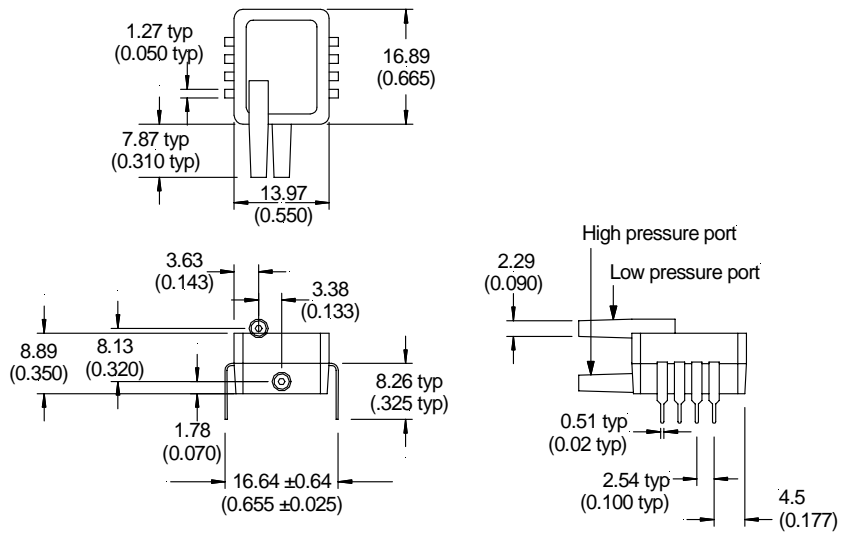

G2 package

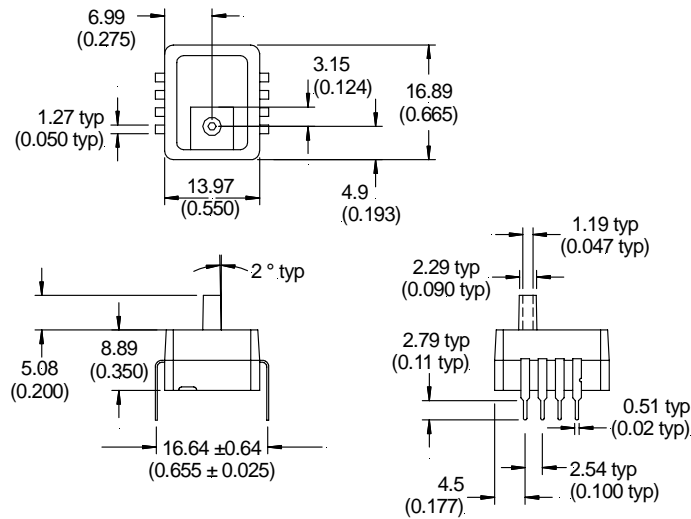

A2 package

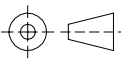
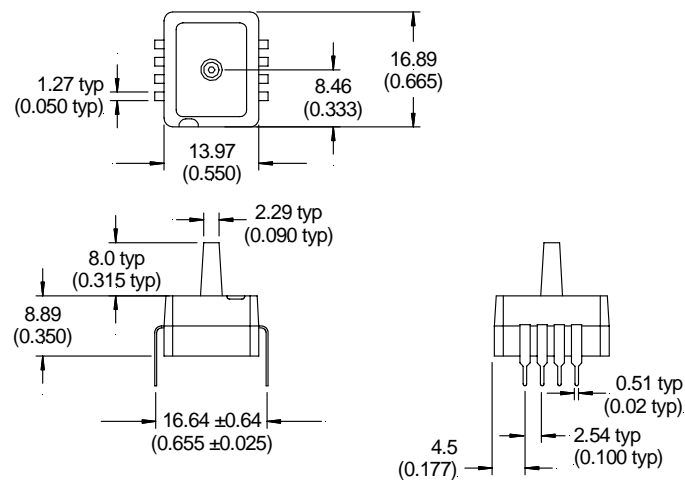

third angle projection

dimensions in mm (inches)

CSDX Series

Digital pressure transducers

ELECTRICAL CONNECTIONS

CSDX...D4...

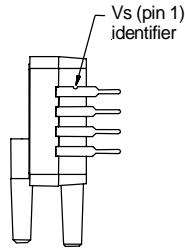
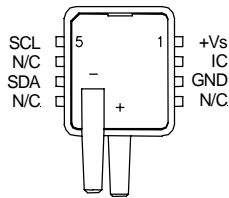

CSDX...G2R

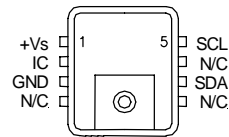
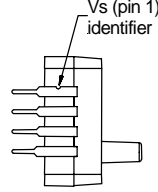

**CSDX...A2R,
CSDX...BARO**

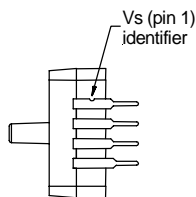
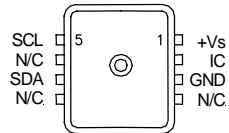

Note: Pins 4, 6 and 8 are internal device connections and should not be connected for any reason.

Pin 2 is an internal device connection and should be connected to ground with a 15 nF capacitor.

ORDERING INFORMATION

Pressure range	Absolute	Gage	Differential/Gage
0 to 25 mbar		-	CSDX0025D4R
0 to 50 mbar		CSDX0050G2R	CSDX0050D4R
0 to 100 mbar		CSDX0100G2R	CSDX0100D4R
0 to 250 mbar		CSDX0250G2R	CSDX0250D4R
0 to 500 mbar		CSDX0500G2R	CSDX0500D4R
800 to 1100 mbar	CSDX0811BARO	-	-
0 to 1 bar	CSDX1000A2R	CSDX1000G2R	CSDX1000D4R
0 to 2 bar	CSDX2000A2R	CSDX2000G2R	CSDX2000D4R
0 to 5 bar	CSDX5000A2R	CSDX5000G2R	CSDX5000D4R
0 to ±10 mbar			CSDX0010D4D
0 to ±25 mbar			CSDX0025D4D
0 to ±50 mbar			CSDX0050D4D
0 to ±100 mbar			CSDX0100D4D
0 to ±250 mbar			CSDX0250D4D
0 to ±500 mbar			CSDX0500D4D
0 to ±1 bar			CSDX1000D4D

Other pressure ranges or calibrations are available on request

Sensortech reserves the right to make changes to any products herein. Sensortech does not assume any liability arising out of the application or use of any product or circuit described herein, neither does it convey any license under its patent rights nor the rights of others.