

**48Vin  
Input**

**28Vout  
Output**

**26Amp  
Current**

**2250Vdc  
Isolation**

**Full-brick  
DC/DC Converter**

The PQ60280FTA26 PowerQor® Tera converter is an isolated, fixed switching frequency DC/DC converter that uses synchronous rectification and a patented topology to achieve extremely high efficiency and power density. This module is ideally suited to support wireless base station amplifiers and for applications to drive cooling fans used in networking systems, servers and data storage units. The Tera series converters offer industry leading useable output power for any standard "full-brick" module. These 28Vout modules are available in open frame and baseplated versions. RoHS compliant (see page 13).




PQ60280FTA26 Module

### Operational Features

- Ultra-high efficiency, 95% at full rated load current, 96% at half rated load current
- Delivers up to 728 Watts of output power with minimal derating
- Input voltage range: 36V – 75V, with 100V for 100ms input transient capability
- Fixed frequency switching provides predictable EMI performance
- On-board input and output filtering

### Mechanical Features

- Industry standard full-brick pin-out configuration
- Industry standard size: 4.6" x 2.4" (116.8 x 61.0mm)
- Total height only 0.50" (12.7mm), open frame unit only 0.43" (10.8mm)
- Total weight: 10.0oz. (284 grams), open frame unit only 5.0 oz. (142 grams)

### Safety Features

- 2250V, 30 M $\Omega$  input-to-output isolation
- UL/cUL 60950-1 recognized (US & Canada), basic insulation rating
- TUV certified to EN60950-1
- Meets 72/23/EEC and 93/68/EEC directives
- Meets UL94V-0 flammability requirements

### Protection Features

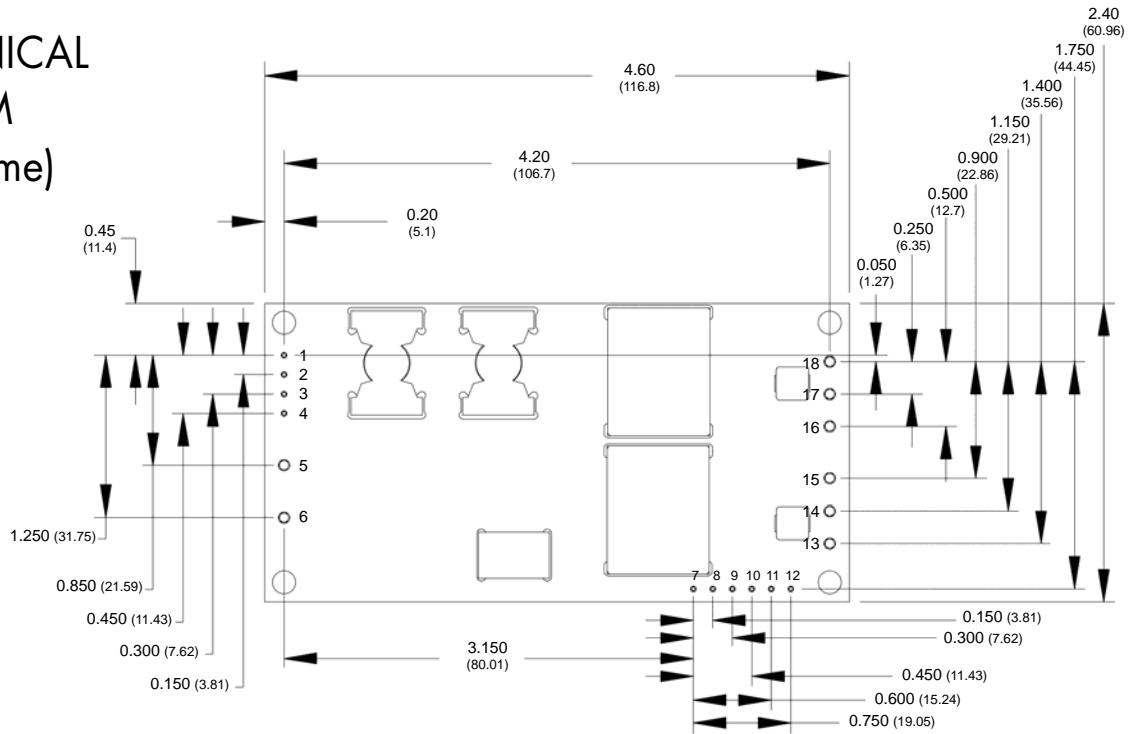
- Input under-voltage lockout disables converter at low input voltage conditions
- Output current limit and short circuit protection protects converter and load from damage
- Active back bias limit prevents damage to converter from external load induced pre-bias
- Output over-voltage protection
- Thermal shutdown

### Control Features

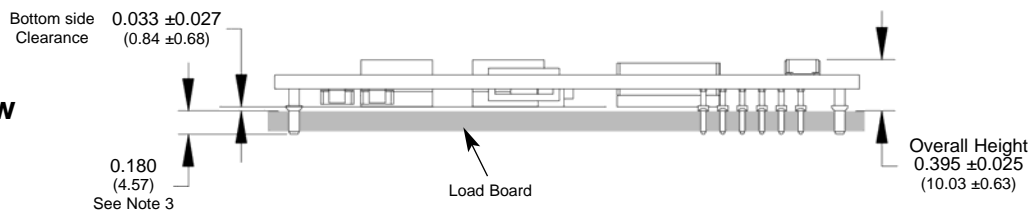
- Fully isolated On/Off control (positive and negative logic options are available)
- Remote sense for the output voltage compensates for output distribution drops
- Output voltage trim permits custom voltages and voltage margining
- Synchronization feature available (full feature only)
- Paralleling capability

### MECHANICAL DIAGRAM (open frame)

**Top View**



**Side View**



### NOTES

- 1) Pins 1-4, 7-12 are 0.040" (1.02mm) diameter, with 0.080" (2.03mm) diameter standoff shoulders.
- 2) Pins 5-6, 13-18 are 0.080" (2.03 mm) diameter with 0.125" (3.18mm) diameter standoff shoulders.
- 3) Other pin extension lengths available. Recommended pin length is 0.03" (0.76mm) greater than the PCB thickness.
- 4) All Pins: Material - Copper Alloy  
Finish - Matte Tin over Nickel plate
- 5) Undimensioned components are shown for visual reference only.
- 6) All dimensions in inches (mm)  
Tolerances: x.xx +/-0.02 in. (x.x +/-0.5mm)  
x.xxx +/-0.010 in. (x.xx +/-0.25mm)
- 7) Weight: 5 oz. (142 g) typical
- 8) Workmanship: Meets or exceeds current IPC-A-610 Class II
- 9) UL/TUV standards require a clearance greater than 0.04" (1.02mm) between input and output for Basic insulation. This issue should be considered if any copper traces are on the top side of the user's board. Note that the ferrite cores are considered part of the input/primary circuit.

### PIN DESIGNATIONS

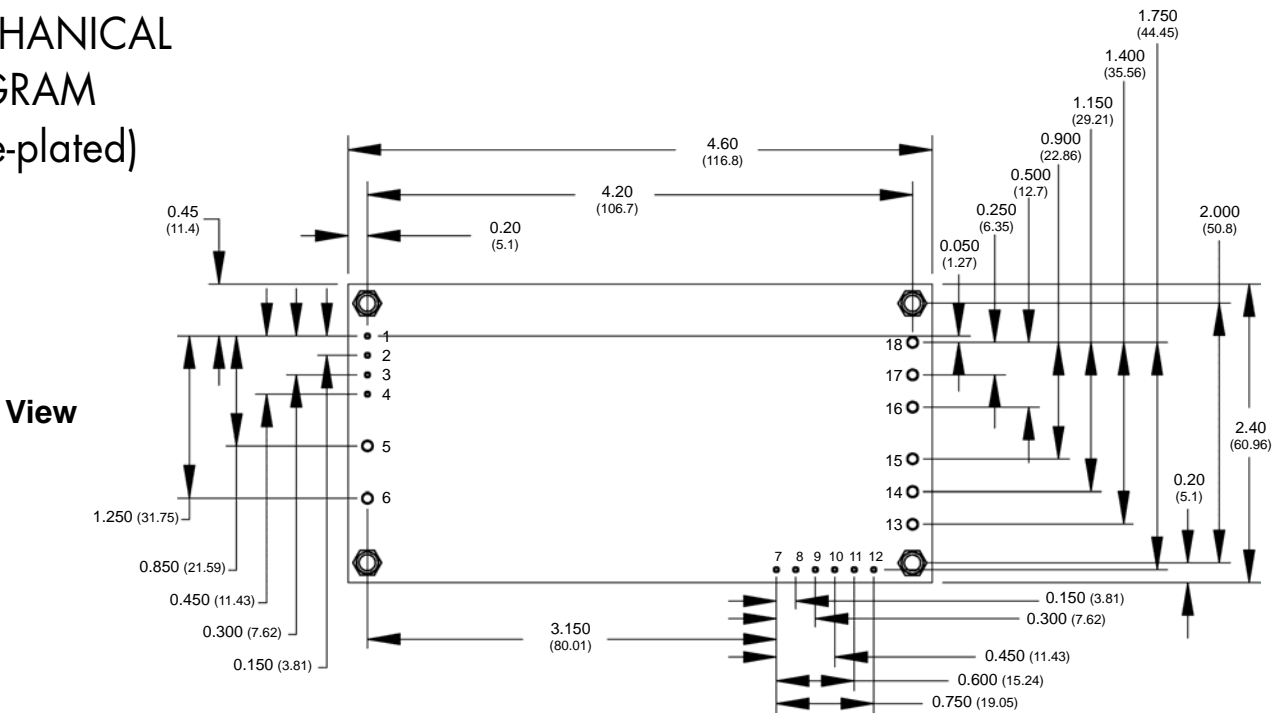
Pin No.	Name	Function
1	SynIn	Synchronization Input (full feature versions only)
2	SynOut	Synchronization Output (full feature versions only)
3	+ON/OFF	Turn converter on and off, referenced to - ON/OFF
4	- ON/OFF	Fully isolated ground
5	Vin(+)	Positive input voltage
6	Vin(-)	Negative input voltage
7	Vaux	Remote ON/OFF power, referenced to Vout(-)
8	IOG	Power Good or Inverted Operation Good
9	PARALLEL	Current share
10	TRIM	Output voltage trim <sup>1</sup>
11	SENSE(+)	Positive remote sense <sup>2</sup>
12	SENSE(-)	Negative remote sense <sup>3</sup>
13	Vout(-)	Negative output voltage
14	Vout(-)	Negative output voltage
15	Vout(-)	Negative output voltage
16	Vout(+)	Positive output voltage
17	Vout(+)	Positive output voltage
18	Vout(+)	Positive output voltage

Pin Designations Notes:

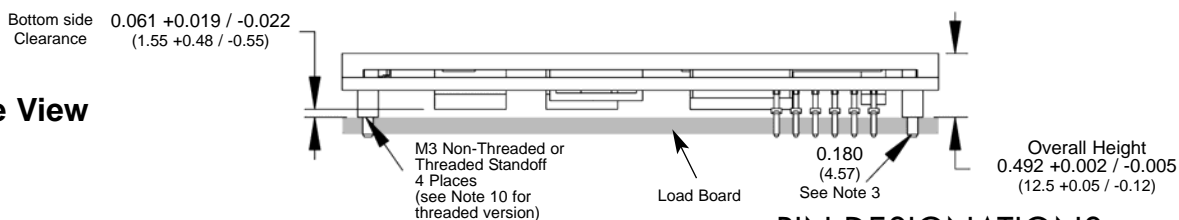
1. Leave TRIM pin open for nominal output voltage.
2. SENSE(+) should be connected to Vout(+) either remotely or at the converter.
3. SENSE(-) should be connected to Vout(-) either remotely or at the converter.

### MECHANICAL DIAGRAM (base-plated)

Top View



Side View



### NOTES

- 1) Pins 1-4, 7-12 are 0.040" (1.02mm) diameter, with 0.080" (2.03mm) diameter standoff shoulders.
- 2) Pins 5-6, 13-18 are 0.080" (2.03 mm) diameter with 0.125" (3.18mm) diameter standoff shoulders.
- 3) Other pin extension lengths available. Recommended pin length is 0.03" (0.76mm) greater than the PCB thickness.
- 4) All Pins: Material - Copper Alloy  
Finish - Matte Tin over Nickel plate
- 5) Undimensioned components are shown for visual reference only.
- 6) All dimensions in inches (mm)  
Tolerances: x.xx +/-0.02 in. (x.x +/-0.5mm)  
x.xxx +/-0.010 in. (x.xx +/-0.25mm)
- 7) Weight: 10 oz. (284 g) typical
- 8) Workmanship: Meets or exceeds IPC-A-610C Class II
- 9) UL/TUV standards require a clearance greater than 0.04" (1.02mm) between input and output for Basic insulation. This issue should be considered if any copper traces are on the top side of the user's board. Note that the ferrite cores are considered part of the input/primary circuit.
- 10) Applied torque per screw should not exceed 3 in-lb (.33Nm)

### PIN DESIGNATIONS

Pin No.	Name	Function
1	SynIn	Synchronization Input (full feature versions only)
2	SynOut	Synchronization Output (full feature versions only)
3	+ON/OFF	Turn converter on and off, referenced to - ON/OFF
4	- ON/OFF	Fully isolated ground
5	Vin(+)	Positive input voltage
6	Vin(-)	Negative input voltage
7	Vaux	Remote ON/OFF power, referenced to Vout(-)
8	IOG	Power Good or Inverted Operation Good
9	PARALLEL	Current share
10	TRIM	Output voltage trim <sup>1</sup>
11	SENSE(+)	Positive remote sense <sup>2</sup>
12	SENSE(-)	Negative remote sense <sup>3</sup>
13	Vout(-)	Negative output voltage
14	Vout(-)	Negative output voltage
15	Vout(-)	Negative output voltage
16	Vout(+)	Positive output voltage
17	Vout(+)	Positive output voltage
18	Vout(+)	Positive output voltage

#### Pin Designations Notes:

1. Leave TRIM pin open for nominal output voltage.
2. SENSE(+) should be connected to Vout(+) either remotely or at the converter.
3. SENSE(-) should be connected to Vout(-) either remotely or at the converter.





# Technical Specification

**Input: 36-75 V**  
**Output: 28 V**  
**Current: 26 A**  
**Package: Full-brick**

## PQ60280FTA26 ELECTRICAL CHARACTERISTICS

T<sub>A</sub>=25°C, airflow rate=300 LFM, V<sub>in</sub>=48Vdc unless otherwise noted; full operating temperature range is -40°C to +100°C ambient temperature with appropriate power derating. Specifications subject to change without notice.

Parameter	Min.	Typ.	Max.	Units	Notes & Conditions
<b>ABSOLUTE MAXIMUM RATINGS</b>					
Input Voltage					
Non-Operating			100	V	Continuous
Operating			80	V	Continuous
Operating Transient Protection			100	V	100ms transient
Isolation Voltage (input to output)			2250	V	Basic insulation level, Pollution degree 2
Operating Temperature	-40		100	°C	
Storage Temperature	-55		125	°C	
Voltage at ON/OFF input pin	-2		18	V	
<b>INPUT CHARACTERISTICS</b>					
Operating Input Voltage Range	36	48	75	V	
Input Under-Voltage Lockout					
Turn-On Voltage Threshold	31.5	33.3	34.7	V	
Turn-Off Voltage Threshold	29.5	31.0	32.4	V	
Lockout Voltage Hysteresis		2.3		V	
Maximum Input Current			22.0	A	100% Load, 36 Vin
No-Load Input Current		220	250	mA	
Disabled Input Current		42	65	mA	
Inrush Current Transient Rating			0.1	A <sup>2</sup> s	
Input Reflected Ripple Current			60	mA	RMS thru 4.7µH inductor; Figures 11 & 13
Input Terminal Ripple Current		3		A	RMS; Figures 11 & 12
Recommended Input Fuse			30	A	Fast blow external fuse recommended
Input Filter Component Values (L\C)		0.2 \ 8.0		µH\µF	Internal values
Recommended External Input Capacitance		200		µF	Typical ESR 0.2Ω, see Figure 11
Recommended External Input Capacitor ESR1	0.04	0.20	1.00	Ω	100kHz, -40°C to 100°C
<b>OUTPUT CHARACTERISTICS</b>					
Output Voltage Set Point	27.75	28.00	28.25	V	
Output Voltage Regulation					
Over Line		±0.05 \ 28	±0.10 \ 28	%\mV	
Over Load		±0.1 \ 28	±0.2 \ 56	%\mV	
Over Temperature		±45	±90	mV	
Total Output Voltage Range	27.50		28.50	V	Over sample, line, load, temperature & life
Output Voltage Ripple and Noise <sup>1</sup>					20MHz bandwidth; Figures 11 & 14
Peak-to-Peak		180	250	mV	Full Load; see Figures 11 & 14
RMS		40	50	mV	Full Load; see Figures 11 & 14
Operating Output Current Range	0		26	A	Subject to thermal derating; Figures 5 - 6
Output DC Current-Limit Inception	28.0	30.2	32.0	A	Output Voltage 10% Low; Figure 22
Back-Drive Current-Limit While Enabled	1.50	3.40	5.00	A	Negative current drawn from output
Back-Drive Current-Limit While Disabled	0.14	0.30	0.45	A	Negative current drawn from output
Current Share Accuracy (2 units paralleled)		2.5		A	
Maximum Output Capacitance			4,000	µF	28Vout at 26A Resistive Load
<b>DYNAMIC CHARACTERISTICS</b>					
Input Voltage Ripple Rejection		30		dB	120 Hz; Figure 18
Output Voltage during Load Current Transient					
For a Step Change in Output Current (0.1A/µs)		1500		mV	50-75-50% Iout max; 47µF cap; Figure 9
For a Step Change in Output Current (5A/µs)		800		mV	50-75-50% Iout max; 47µF cap; Figure 10
Settling Time		150		µs	To within 1% Vout nom
Turn-On Transient					
Turn-On Time	25	30	35	ms	Full load, Vout=90% nom.; Figures 7 & 8
Startup Delay:		2		ms	
First Startup Delay:		200		ms	
Restart Inhibit Delay:		320		ms	
Output Voltage Overshoot		0		%	4,000 µF load capacitance, Iout = 26A resistive load
<b>EFFICIENCY</b>					
100% Load		95		%	Figures 1 - 4 (Figure 21 for baseplated)
50% Load		96		%	Figures 1 - 4 (Figure 21 for baseplated)
<b>TEMPERATURE LIMITS FOR POWER DERATING CURVES</b>					
Semiconductor Junction Temperature			125	°C	Package rated to 150°C
Board Temperature			125	°C	UL rated max operating temp 130°C
Transformer Temperature			125	°C	See Figures 5 - 6 for derating curve
Maximum Baseplate Temperature <sup>2</sup>			100	°C	Applies to baseplated units only
<b>ISOLATION CHARACTERISTICS</b>					
Isolation Voltage (dielectric strength)		2250		V	
Isolation Resistance		30		MΩ	
Isolation Capacitance <sup>3</sup>		3300		pF	

Note 1: For applications requiring reduced output voltage ripple and noise, consult SynQor applications support (e-mail: [support@synqor.com](mailto:support@synqor.com))

Note 2: There is no derating with a baseplate temperature of 100°C or lower.

Note 3: Higher values of isolation capacitance can be added external to the module.



# Technical Specification

**Input:** 36-75 V  
**Output:** 28 V  
**Current:** 26 A  
**Package:** Full-brick

## ELECTRICAL CHARACTERISTICS (Continued)

Parameter	Min.	Typ.	Max.	Units	Notes & Conditions
<b>FEATURE CHARACTERISTICS</b>					
Switching Frequency	275	300	325	kHz	Regulation and isolation stages
ON/OFF Control (Option P)					
On Current (threshold)	0.1	0.5	1	mA	
Off Current (threshold)			50	µA	
ON/OFF Control (Option N)					
On Current (threshold)			50	µA	
Off Current (threshold)	0.1	0.5	1	mA	
Maximum allowable current through ON/OFF Pin			4	mA	
Auxiliary Power Supply Voltage	6.0		9.0	V	
Auxiliary Power Supply Current	0.0		20.0	mA	
Output Voltage Trim Range	-50		+15	%	Measured across Pins 9 & 5; Figure C
Output Voltage Remote Sense Range			+15	%	Measured across Pins 9 & 5
Output Over-Voltage Protection	33		37	V	Over full temp range; % of nominal Vout
Over-Temperature Shutdown		120		°C	Average PCB Temperature
Over-Temperature Shutdown Restart Hysteresis		10		°C	
Load Current Scale Factor		833			See App Note: Output Load Current Calc.
<b>RELIABILITY CHARACTERISTICS</b>					
Calculated MTBF (Telcordia)		2.13		106 Hrs.	TR-NWT-000332; 80% load, 300LFM, 40°C Ta
Calculated MTBF (MIL-217)		1.93		106 Hrs.	MIL-HDBK-217F; 80% load, 300LFM, 40°C Ta
Field Demonstrated MTBF		TBD		106 Hrs.	See our <a href="#">website</a> for details

## STANDARDS COMPLIANCE

Parameter	Notes
<b>STANDARDS COMPLIANCE</b>	
UL/cUL 60950-1	File # E194341, Basic insulation & pollution degree 2
EN60950-1	Certified by TÜV
72/23/EEC	
93/68/EEC	
Needle Flame Test (IEC 695-2-2)	Test on entire assembly; board & plastic components UL94V-0 compliant
IEC 61000-4-2	ESD test, 8kV - NP, 15kV air - NP (Normal Performance)
GR-1089-CORE	Section 7 - electrical safety, Section 9 - bonding/grounding
Telcordia (Bellcore) GR-513	

- An external input fuse must always be used to meet these safety requirements. Contact SynQor for official safety certificates on new releases or download from the [SynQor website](#).

## QUALIFICATION TESTING

Parameter	# Units	Test Conditions
<b>QUALIFICATION TESTING</b>		
Life Test	32	95% rated Vin and load, units at derating point, 1000 hours
Vibration	5	10-55Hz sweep, 0.060" total excursion, 1 min./sweep, 120 sweeps for 3 axis
Mechanical Shock	5	100g minimum, 2 drops in x and y axis, 1 drop in z axis
Temperature Cycling	10	-40°C to 100°C, unit temp. ramp 15°C/min., 500 cycles
Power/Thermal Cycling	5	Toperating = min to max, Vin = min to max, full load, 100 cycles
Design Marginality	5	Tmin-10°C to Tmax+10°C, 5°C steps, Vin = min to max, 0-105% load
Humidity	5	85°C, 85% RH, 1000 hours, 2 minutes on and 6 hours off
Solderability	15 pins	MIL-STD-883, method 2003 and JESD22-B102D

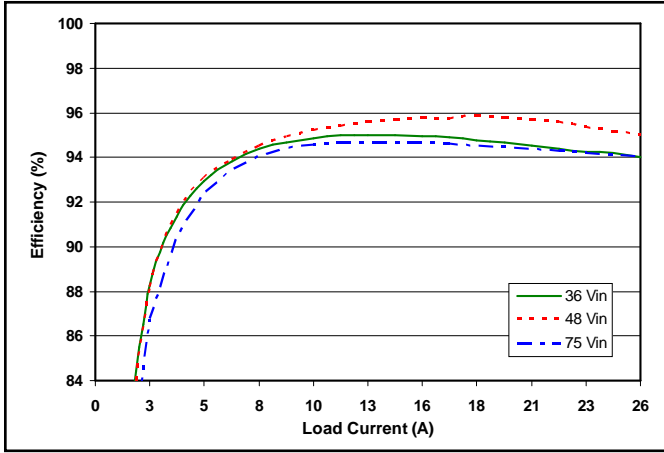
- Extensive characterization testing of all SynQor products and manufacturing processes is performed to ensure that we supply robust, reliable product. Contact the factory for official product family qualification documents.

## OPTIONS

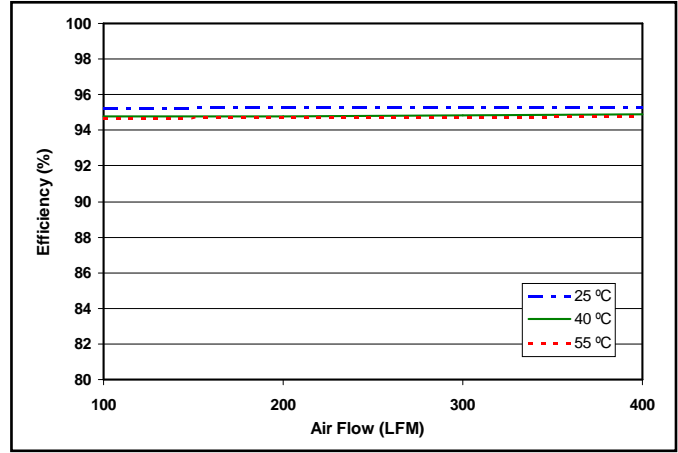
SynQor provides various options for this family of dc-dc converters. Please consult the [last page](#) for additional information.

## PATENTS

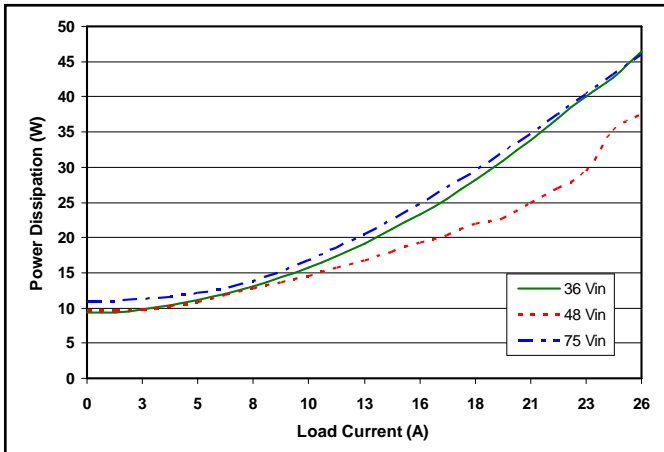
SynQor is protected under various patents. Please consult the [last page](#) for further details.



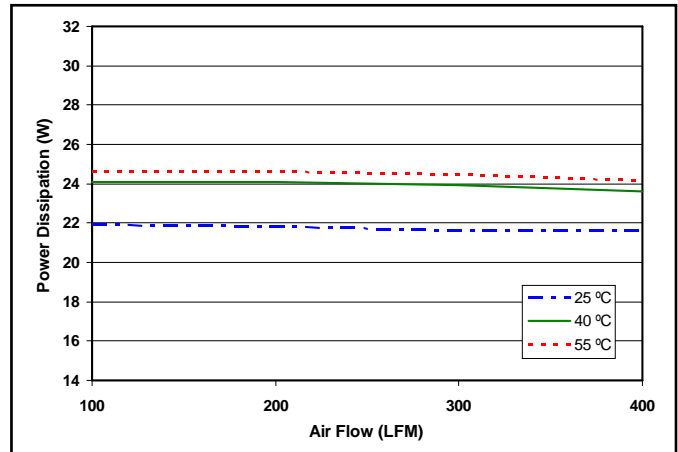
**Figure 1:** Efficiency at nominal output voltage vs. load current for minimum, nominal, and maximum input voltage at 25°C.



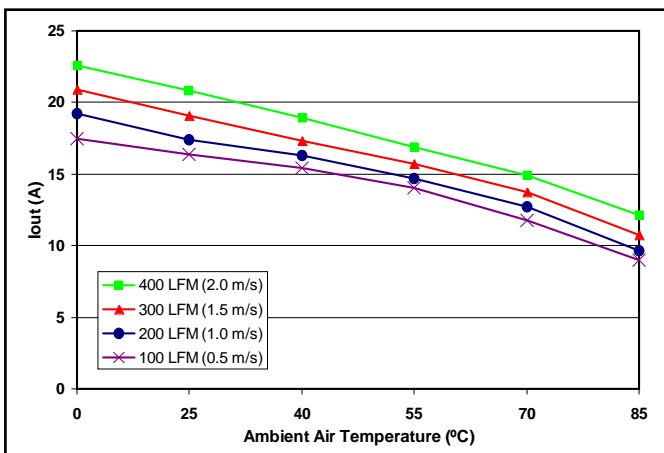
**Figure 2:** Efficiency at nominal output voltage and 60% rated power vs. airflow rate for ambient air temperatures of 25°C, 40°C, and 55°C (nominal input voltage).



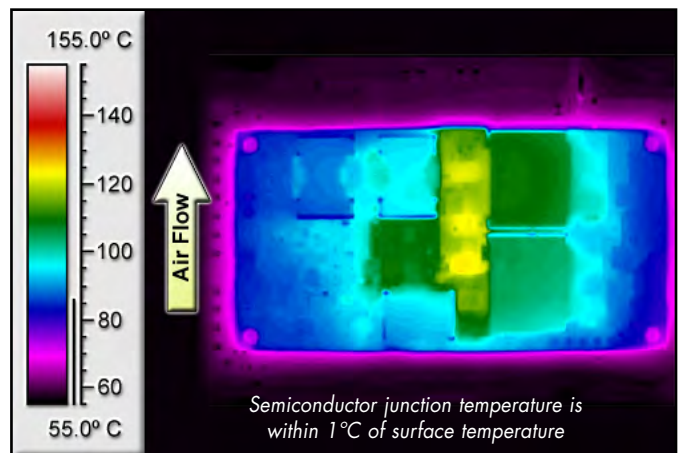
**Figure 3:** Power dissipation at nominal output voltage vs. load current for minimum, nominal, and maximum input voltage at 25°C.



**Figure 4:** Power dissipation at nominal output voltage and 60% rated power vs. airflow rate for ambient air temperatures of 25°C, 40°C, and 55°C (nominal input voltage).

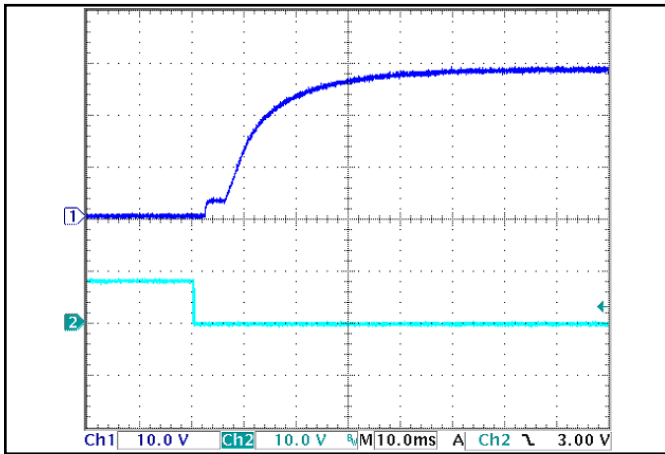


**Figure 5:** Maximum output power derating curves vs. ambient air temperature for airflow rates of 100 LFM through 400 LFM with air flowing from pin 1 to pin 2 (nominal input voltage). See Figure 21 for baseplate derating curve.

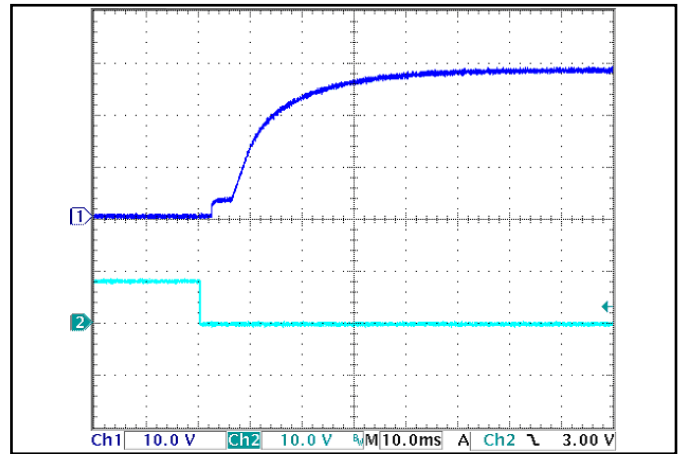


**Figure 6:** Thermal plot of converter at 14.7 amp load current (411.6W) with 55°C air flowing at the rate of 200 LFM. Air is flowing from pin 1 to pin 2 (nominal input voltage).

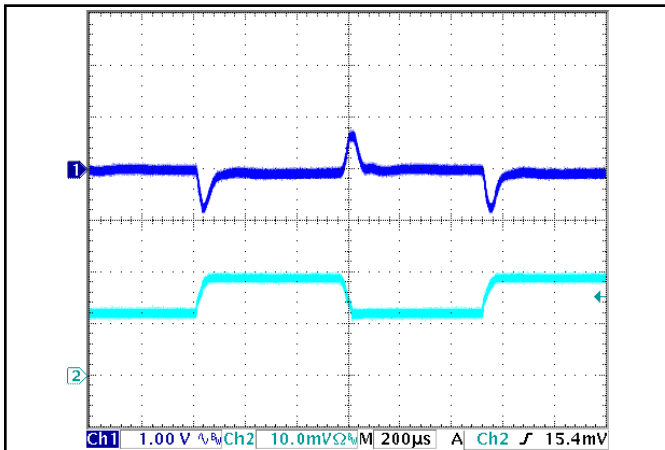




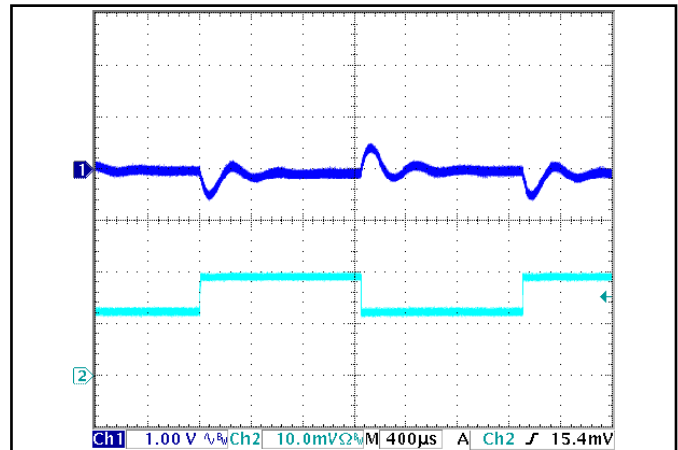
**Figure 7:** Turn-on transient at full load (resistive load) (10 ms/div). Input voltage pre-applied. Top Trace:  $V_{out}$  (10V/div). Bottom Trace: ON/OFF input (10V/div)



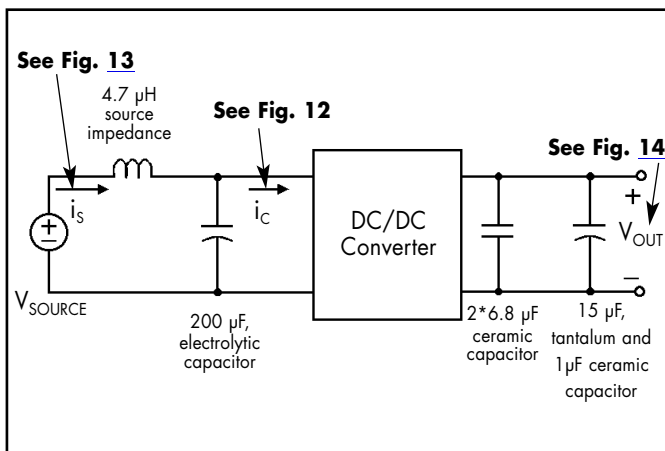
**Figure 8:** Turn-on transient at zero load (10 ms/div). Top Trace:  $V_{out}$  (10V/div). Bottom Trace: ON/OFF input (10V/div)



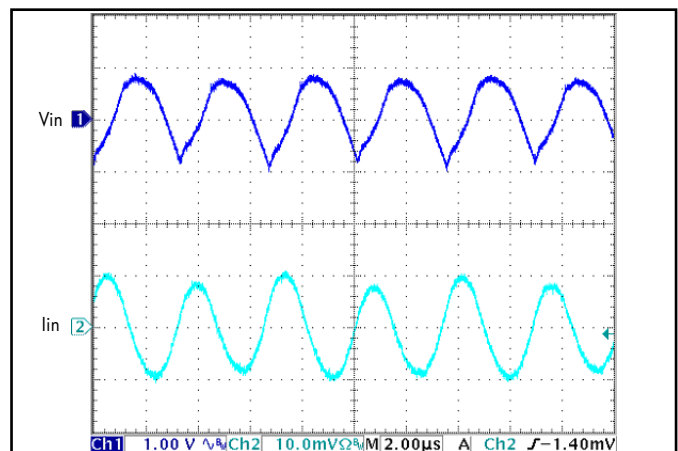
**Figure 9:** Output voltage response to step-change in load current (50%-75%-50% of  $I_{out(max)}$ ;  $dI/dt = 0.1A/\mu s$ ). Load cap:  $47\mu F$ , ceramic output capacitance. Top trace:  $V_{out}$  (1V/div). Bottom trace:  $I_{out}$  (5A/div).



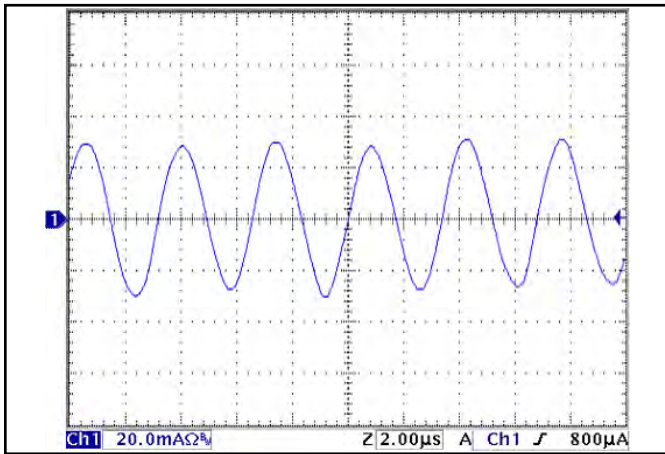
**Figure 10:** Output voltage response to step-change in load current (50%-75%-50% of  $I_{out(max)}$ ;  $dI/dt = 5A/\mu s$ ). Load cap:  $47\mu F$ , ceramic output capacitance. Top trace:  $V_{out}$  (2V/div). Bottom trace:  $I_{out}$  (5A/div).



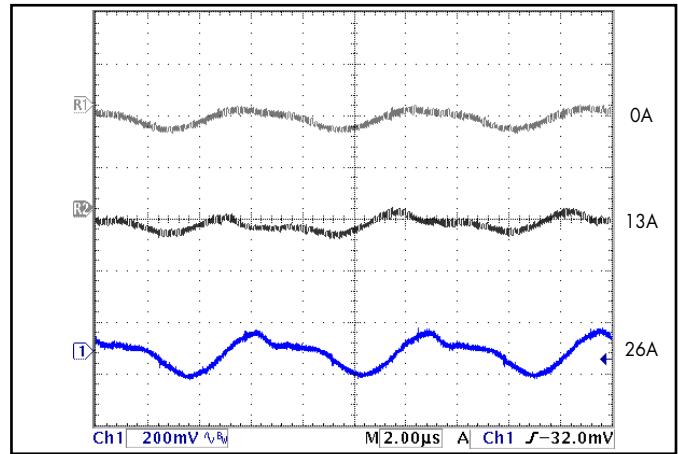
**Figure 11:** Test set-up diagram showing measurement points for Input Terminal Ripple Current (Figure 12), Input Reflected Ripple Current (Figure 13) and Output Voltage Ripple (Figure 14).



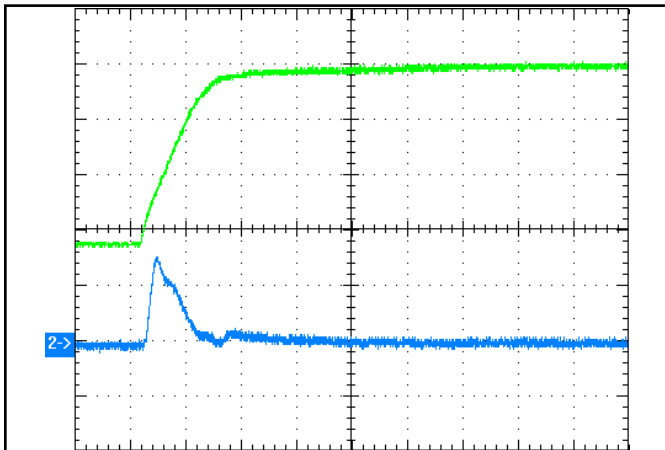
**Figure 12:** Input Terminal Ripple Current,  $i_c$ , at full rated output current and 75V input voltage with  $4.7\mu H$  source impedance and  $200\mu F$  electrolytic capacitor (Ch2 5A/div). (See Figure 11).



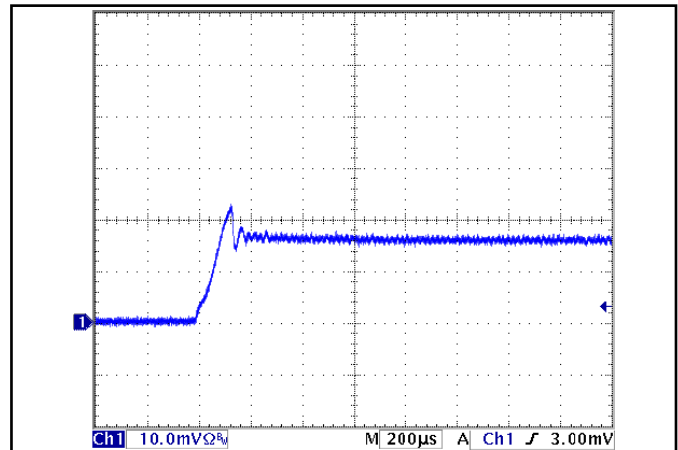
**Figure 13:** Input reflected ripple current,  $i_s$ , through a  $4.7 \mu\text{H}$  source inductor at 75V input voltage and rated load current (50 mA/div). (See Figure 11).



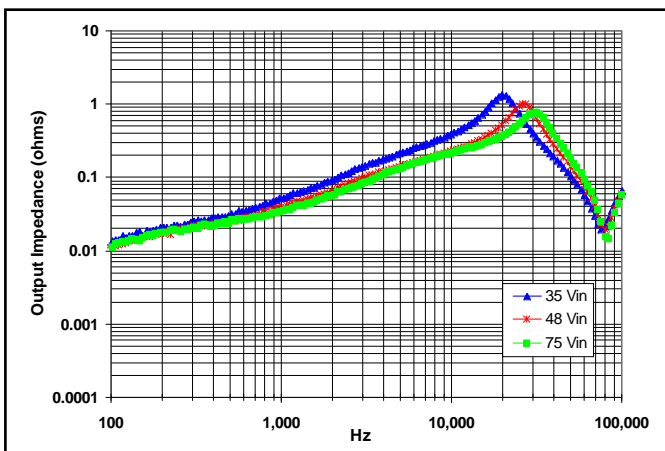
**Figure 14:** Output voltage ripple at nominal input voltage and rated load current (200 mV/div). Load capacitance: two  $6.8 \mu\text{F}$  ceramic capacitors and  $15 \mu\text{F}$  tantalum capacitor. Bandwidth: 20 MHz. (See Figure 11).



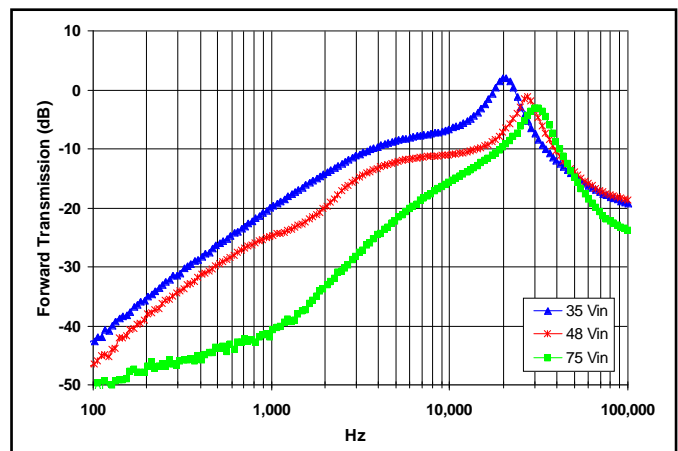
**Figure 15:** Output voltage response to step-change in input voltage (1000V/ms). Load cap: no output capacitance. Ch 1:  $V_{out}$  (2V/div), Ch 2:  $V_{in}$  (20V/div).



**Figure 16:** Load current (20A/div) as a function of time when the converter attempts to turn on into a  $1 \text{ m}\Omega$  short circuit.

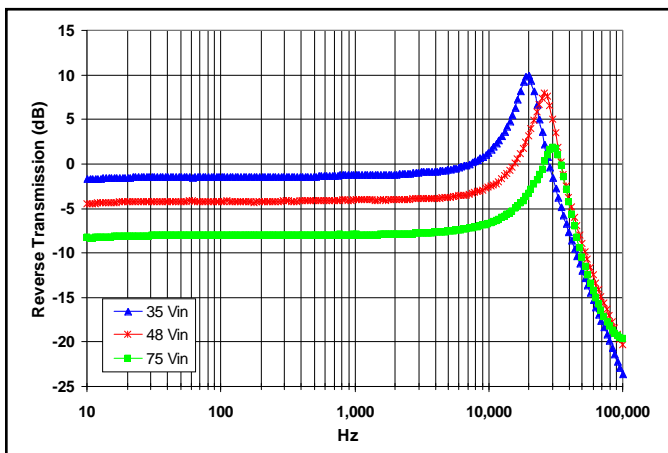


**Figure 17:** Magnitude of incremental output impedance ( $Z_{out} = v_{out}/i_{out}$ ) for minimum, nominal, and maximum input voltage at full rated power.

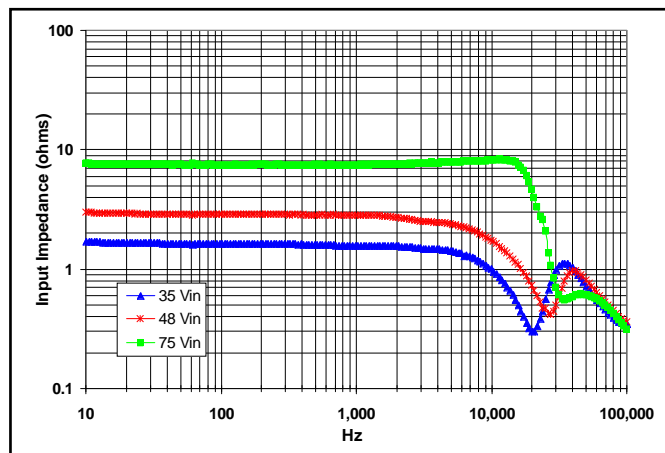


**Figure 18:** Magnitude of incremental forward transmission ( $FT = v_{out}/v_{in}$ ) for minimum, nominal, and maximum input voltage at full rated power.

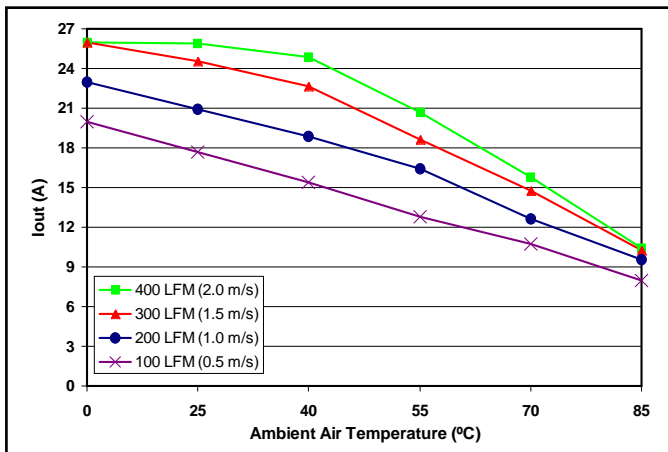




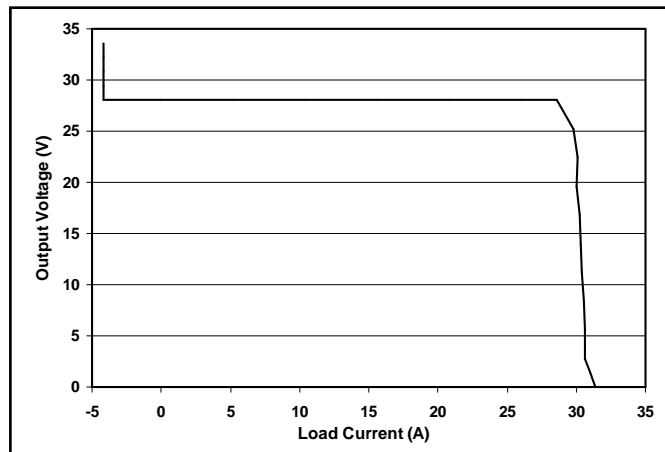
**Figure 19:** Magnitude of incremental reverse transmission ( $RT = i_{in}/i_{out}$ ) for minimum, nominal, and maximum input voltage at full rated power.



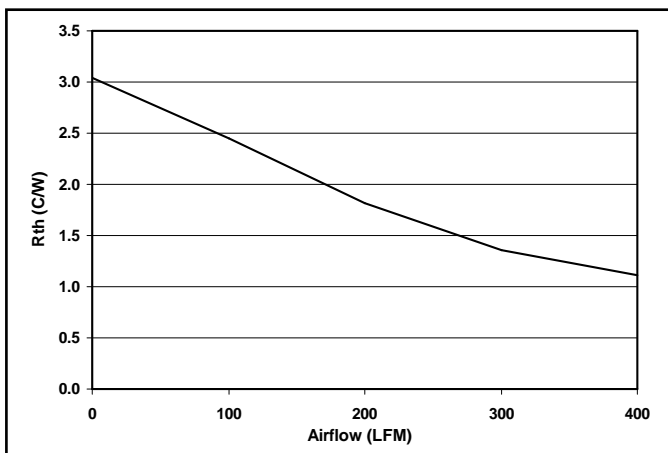
**Figure 20:** Magnitude of incremental input impedance ( $Z_{in} = v_{in}/i_{in}$ ) for minimum, nominal, and maximum input voltage at full rated power.



**Figure 21:** Baseplated unit maximum output power derating curves vs. ambient air temperature for airflow rates of 100 LFM through 400 LFM with air flowing from input to output (nominal input voltage). No derating if baseplate is  $\leq 100^\circ\text{C}$ .



**Figure 22:** Output voltage vs. load current showing typical current limit curves and converter shutdown points.



**Figure 23:** Thermal resistance ( $R_{thca}$ ) plot at 50% output power (base-plated, no-heat-sink configuration).

### BASIC OPERATION AND FEATURES

The PowerQor series converter uses a two-stage power conversion topology. The first stage keeps the output voltage constant over variations in line, load, and temperature. The second stage uses a transformer to provide the functions of input/output isolation and voltage step-down to achieve the low output voltage required.

Both the first stage and the second stage switch at a fixed frequency for predictable EMI performance. Rectification of the transformer's output is accomplished with synchronous rectifiers. These devices, which are MOSFETs with a very low on-state resistance, dissipate far less energy than Schottky diodes. This is the primary reason that the PowerQor converter has such high efficiency, even at very low output voltages and very high output currents.

Dissipation throughout the converter is so low that it does not require a heatsink for operation. Since a heatsink is not required, the PowerQor series of converters do not need a metal baseplate or potting material to help conduct the dissipated energy to the heatsink. The PowerQor series of converters can thus be built more simply and reliably using high yield surface mount techniques on a PCB substrate.

The PowerQor series converters use the industry standard footprint and pin-out configuration.

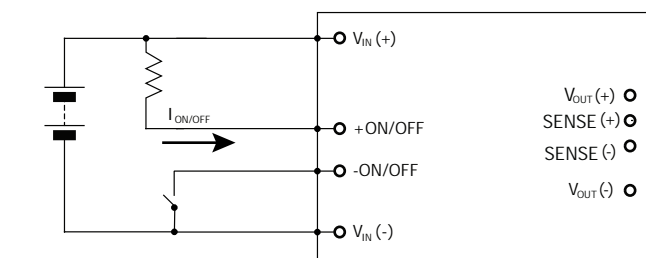


Figure A: Typical circuit for driving the ON/OFF pin.

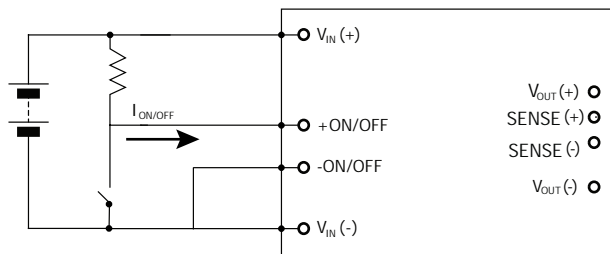


Figure B: Another circuit for driving the ON/OFF pin.

### CONTROL FEATURES

**REMOTE ON/OFF (Pin 3):** The (+)ON/OFF input, Pin 3, permits the user to control when the converter is on or off. This input is referenced (-)ON/OFF. There are two versions of the converter that differ by the sense of the logic used for the ON/OFF input.

In the positive logic version, the ON/OFF input is active high (meaning that a high  $I_{ON/OFF}$  turns the converter on). In the negative logic version, the ON/OFF signal is active low (meaning that a low  $I_{ON/OFF}$  turns the converter on). Figures A & B detail two possible circuits for driving the ON/OFF pin.

**REMOTE SENSE(±) (Pins 11 and 12):** The SENSE(±) inputs correct for voltage drops along the conductors that connect the converter's output pins to the load.

Pin 11 should be connected to  $V_{out}(+)$  and Pin 12 should be connected to  $V_{out}(-)$  at the point on the board where regulation is desired. A remote connection at the load can adjust for a voltage drop only as large as that specified in this datasheet, that is

Pins 11 and 12 must be connected for proper regulation of the output voltage. If these connections are not made, the converter will deliver an output voltage that is slightly higher than its specified value.

Note: the output over-voltage protection circuit senses the voltage across the output (pins 16 and 13) to determine when it should trigger, not the voltage across the converter's sense leads (pins 11 and 12). Therefore, the resistive drop on the board should be small enough so that output OVP does not trigger, even during load transients.

**OUTPUT VOLTAGE TRIM (Pin 10):** The TRIM input permits the user to adjust the output voltage across the sense leads up or down according to the trim range specifications.

To decrease the output voltage, the user should connect a resistor between Pin 10 and Pin 12 (SENSE(-) input). For a desired decrease of the nominal output voltage, the value of the resistor should be

$$R_{\text{trim-down}} = \left( \frac{732}{\Delta} \right) - 8.94 \text{ (k}\Omega\text{)}$$

where

$$\Delta\% = \left| \frac{V_{\text{nominal}} - V_{\text{desired}}}{V_{\text{nominal}}} \right| \times 100\%$$

To increase the output voltage, the user should connect a resistor between Pin 7 and Pin 8 (SENSE(+) input). For a desired increase of the nominal output voltage, the value of the resistor should be

$$R_{\text{trim-up}} = \frac{16000 + 158.4 \times (V_{\text{DES}} - V_{\text{NOM}})}{V_{\text{DES}} - V_{\text{NOM}}} \quad (\text{k}\Omega)$$

Figure C graphs the relationship between the trim resistor value and Rtrim-up and Rtrim-down, showing the total range the output voltage can be trimmed up or down.

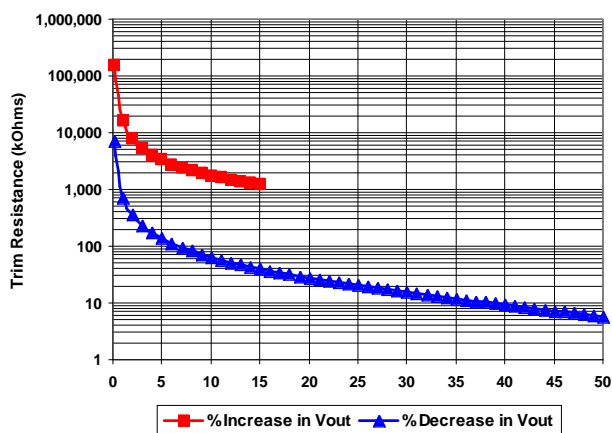


Figure C: Trim Graph for 28Vout module

**Note:** the TRIM feature does not affect the voltage at which the output over-voltage protection circuit is triggered. Trimming the output voltage too high may cause the over-voltage protection circuit to engage, particularly during transients.

It is not necessary for the user to add capacitance at the Trim pin. The node is internally bypassed to eliminate noise.

**Total DC Variation of Vout:** For the converter to meet its full specifications, the maximum variation of the DC value of Vout, due to both trimming and remote load voltage drops, should not be greater than that specified for the output voltage trim range.

**Current Share (pin 9):** The active current share feature allows for N+1 and parallel applications. To achieve load sharing, directly connect the I share pins of multiple units. The load current will share equally among the multiple units. It is important that the Vin(-) pins of the sharing units be directly connected and NOT placed outside of an EMI filter or other impedance path. The voltage at the I Share pin will range from 1 to 2.4 volts (at full rated current), referenced to the primary-side ground, Vin(-)

**SYNCHRONIZATION:** The converter's switching frequency can be synchronized to an external frequency source that is in the 270 kHz to 330 kHz range. A pulse train at the desired frequency should be applied to the SYNC IN pin (pin 1) with respect to the INPUT RETURN (pin 6). Its frequency can be anywhere in that range, regardless of the natural frequency of the power converter. This pulse train should have a duty cycle in the 20% to 80% range. Its low value should be below 0.8V to be guaranteed to be interpreted as a logic low, and its high value should be above 2.0V to be guaranteed to be interpreted as a logic high. The transition time between the two states should be less than 300ns.

If the converter is not to be synchronized, the SYNC IN pin should be left open circuit. The converter will then operate in its free-running mode at a frequency of approximately 300 kHz.

The converter also has a SYNC OUT pin (pin 2). The pulse train coming out of SYNC OUT has a frequency that matches the switching frequency of the converter with which it is associated. This frequency is either the free-running frequency if there is no synchronization signal at the SYNC IN pin, or the synchronization frequency if there is.





## Technical Specification

**Input:** 36-75 V  
**Output:** 28 V  
**Current:** 26 A  
**Package:** Full-brick

### PROTECTION FEATURES

**Input Under-Voltage Lockout:** The converter is designed to turn off when the input voltage is too low, helping avoid an input system instability problem, described in more detail in the application note titled "Input System Instability". The lockout circuitry is a comparator with DC hysteresis. When the input voltage is rising, it must exceed the typical "Turn-On Voltage Threshold" value\* before the converter will turn on. Once the converter is on, the input voltage must fall below the typical Turn-Off Voltage Threshold value before the converter will turn off.

**Output Current Limit:** If the output current exceeds the "Output DC Current Limit Inception" point\*, then a fast linear current limit controller will reduce the output voltage to maintain a constant output current. There is no minimum operating output voltage. The converter will run with low on-board power dissipation down to zero output voltage. A redundant circuit will shut-down the converter if the primary current limit fails.

**Back-Drive Current Limit:** If there is negative output current of a magnitude larger than the "Back-Drive Current Limit while Enabled" specification\*, then a fast back-drive limit controller will increase the output voltage to maintain a constant output current. If this results in the output voltage exceeding the "Output Over-Voltage Protection" threshold\*, then the unit will shut down. The full I-V output characteristic can be seen in Figure 19.

**Output Over-Voltage Limit:** If the voltage across the output pins exceeds the "Output Over-Voltage Protection" threshold\*, the converter will immediately stop switching. This prevents damage to the load circuit due to 1) excessive series resistance in output current path from converter output pins to sense point, 2) a release of a short-circuit condition, or 3) a release of a current limit condition. Load capacitance determines exactly how high the output voltage will rise in response to these conditions.

**Over-Temperature Shutdown:** A temperature sensor on the converter senses the average temperature of the module. The thermal shutdown circuit is designed to turn the converter off when the temperature at the sensed location reaches the Over-Temperature Shutdown value. It will allow the converter to turn on again when the temperature of the sensed location falls by the amount of the Over-Temperature Shutdown Restart Hysteresis value.

**Start-up Inhibit Period:** If any protection feature causes the converter to shut down, the converter will attempt to restart after 320ms (typical), the "Restart Inhibit Period".\* On initial application of input voltage, the first startup delay is about 200ms from input voltage valid to unit output rising. With the on/off pin set to enable the converter, the "Turn-On Time"\* will increase by only 2ms.

\* See [specifications page](#) for details.

### APPLICATION CONSIDERATIONS

**Input System Instability:** This condition can occur because any DC/DC converter appears incrementally as a negative resistance load. A detailed application note titled "Input System Instability" is available on the SynQor website which provides an understanding of why this instability arises, and shows the preferred solution for correcting it.

**Application Circuits:** Figure D below provides a typical circuit diagram which details the input filtering and voltage trimming.

**Input Filtering and External Input Capacitance:** This filter dramatically reduces input terminal ripple current, which otherwise could exceed the rating of an external electrolytic input capacitor. The recommended external input capacitance is specified in the "Input Characteristics" section. More detailed information is available in the application note titled "EMI Characteristics" on the [SynQor website](http://SynQor.com).

### Output Filtering and External Output Capacitance:

Figure E below shows the internal output filter components. This filter dramatically reduces output voltage ripple. However, some minimum external output capacitance is required, as specified in the Output Characteristics section on the [Electrical Specifications page](#). No damage will occur without this capacitor connected, but peak output voltage ripple will be much higher.

**RoHS Compliance:** The EU led RoHS (Restriction of Hazardous Substances) Directive bans the use of Lead, Cadmium, Hexavalent Chromium, Mercury, Polybrominated Biphenyls (PBB), and Polybrominated Diphenyl Ether (PBDE) in Electrical and Electronic Equipment. This SynQor product is available as 6/6 RoHS compliant. For more information please refer to SynQor's RoHS addendum available at our [RoHS Compliance / Lead Free Initiative](#) web page or e-mail us at [rohs@synqor.com](mailto:rohs@synqor.com).

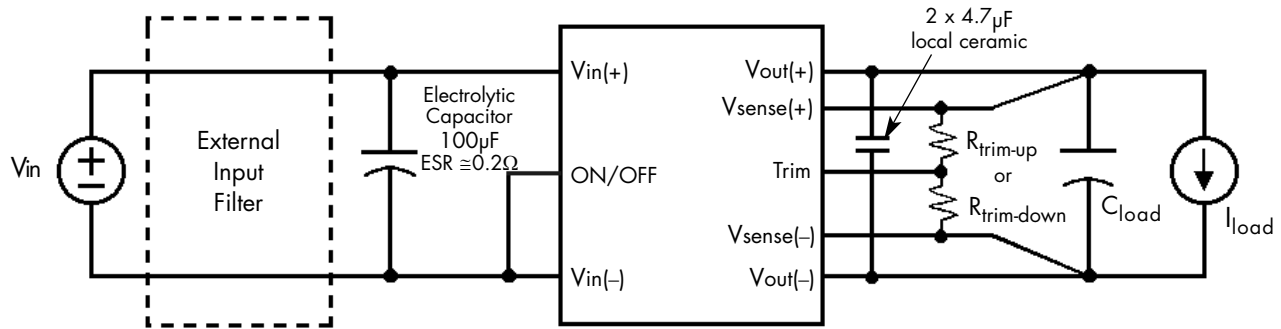


Figure D: Typical application circuit (negative logic unit, permanently enabled).

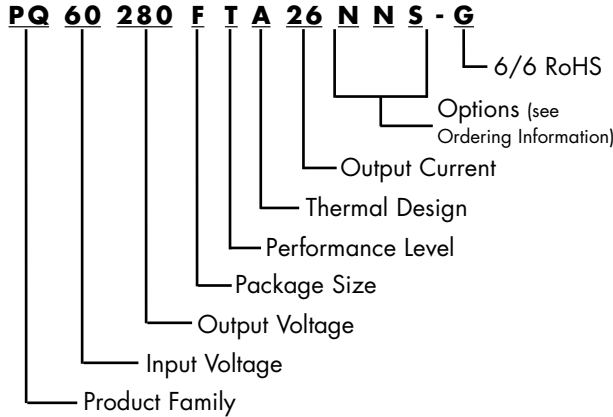


# Technical Specification

**Input: 36-75 V**  
**Output: 28 V**  
**Current: 26 A**  
**Package: Full-brick**

## PART NUMBERING SYSTEM

The part numbering system for SynQor's PowerQor DC/DC converters follows the format shown in the example below.



The first 12 characters comprise the base part number and the last 3 characters indicate available options. Although there are no default values for enable logic and pin length, the most common options are negative logic and 0.145" pins. These part numbers are more likely to be readily available in stock for evaluation and prototype quantities. A "-G" suffix indicates the product is 6/6 RoHS compliant.

## Application Notes

A variety of application notes and technical white papers can be downloaded in pdf format from our [website](#).

## ORDERING INFORMATION

The tables below show the valid model numbers and ordering options for converters in this product family. When ordering SynQor converters, please ensure that you use the complete 15 character part number consisting of the 12 character base part number and the additional 3 characters for options. A "-G" suffix indicates the product is 6/6 RoHS compliant.

Model Number	Input Voltage	Output Voltage	Max Output Current
PQ60280FT w26xyz-G	36 - 75 V	28.0 V	26 A

The following option choices must be included in place of the x y z spaces in the model numbers listed above.

Options Description: w x y z			
Thermal Design	Enable Logic	Pin Length	Feature Set
A - Open Frame	P - Positive	K - 0.110"	S - Standard
B - Threaded Baseplate	N - Negative	N - 0.145"	F - Full Feature
F - Non-Threaded Baseplate		R - 0.180"	
		Y - 0.250"	

## PATENTS

SynQor holds the following patents, one or more of which might apply to this product:

5,999,417	6,222,742	6,545,890	6,577,109
6,594,159	6,731,520	6,894,468	6,896,526
6,927,987	7,050,309	7,072,190	7,085,146
7,119,524	7,269,034	7,272,021	7,272,023

## Contact SynQor for further information:

**Phone:** 978-849-0600  
**Toll Free:** 888-567-9596  
**Fax:** 978-849-0602  
**E-mail:** [power@synqor.com](mailto:power@synqor.com)  
**Web:** [www.synqor.com](http://www.synqor.com)  
**Address:** 155 Swanson Road  
 Boxborough, MA 01719  
 USA

### Warranty

SynQor offers a three (3) year limited warranty. Complete warranty information is listed on our [website](#) or is available upon request from SynQor.

Information furnished by SynQor is believed to be accurate and reliable. However, no responsibility is assumed by SynQor for its use, nor for any infringements of patents or other rights of third parties which may result from its use. No license is granted by implication or otherwise under any patent or patent rights of SynQor.