



Spec. No.	PS-LL-U305YL4-B0
Rev.	A

PRODUCT SPECIFICATION

Model No : CSLR-U305YL4-B0

Descriptions:	
■ LED Type	: Lighting LED Lamp
■ LED Package	: Round LED Lamp
■ Emitting Color	: Yellow
■ Viewing Angle	: 30°
■ No Stopper	



CUSTOMER APPROVED SIGNATURES	APPROVED BY	CHECKED BY	PREPARED BY

CHINA SEMICONDUCTOR CORPORATION
 Address:2FL. NO.909,Chung-Cheng Road,
 Chung-Ho City Taipei Hsien,Taiwan.

OPTO PLUS TECHNOLOGIES CO.,LTD
 Address:696 Shun jiang Rd.,Ji Shan St.Shaoxing,
 ZheJiang,China

Tel:886-2-2223-9696
 Fax:886-2-2223-9377

Tel:86-0575-88623888
 Fax:86-0575-88623112



Model No : CSLR-U305YL4-B0

Features -

1. Low Power Consumption.
2. High Luminous Output
3. High Reliability and Solid Performance
4. Optimal Optical/Mechanical Design
5. Rohs Compliant

Device Selection Guide -

Part No.	Chip		LED Lens
	Material	Emitted Color	
CSLR-U305YL4-B0	AlInGaP	Yellow	Water Transparent

Package Outline Dimensions -

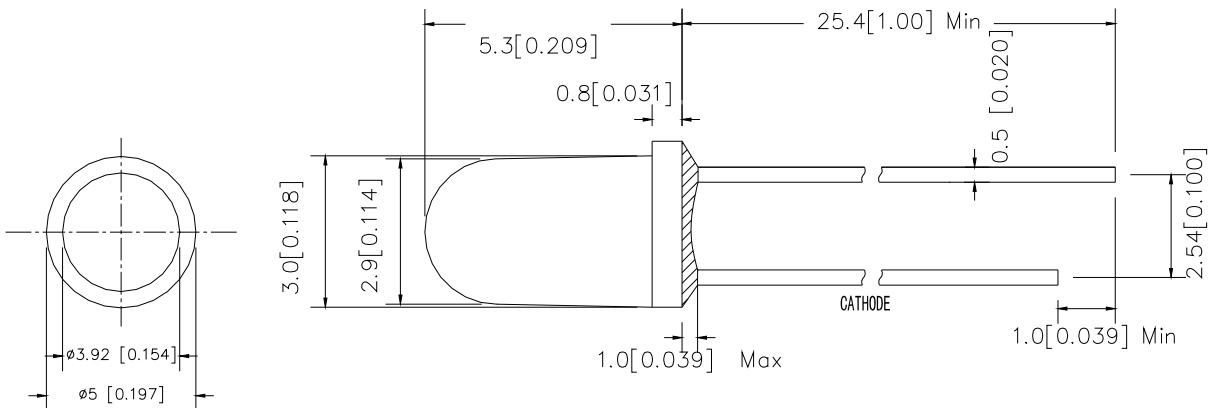

* Tolerance : $\pm \frac{0.01}{0.25}$ Unit : $\pm \frac{\text{inch}}{\text{mm}}$



Model No : CSLR-U305YL4-B0

■ Absolute Maximum Rating -

(Ta=25°C)

Parameter	Symbol	Rating	Unit
Power Dissipation	Pd	52	mW
Forward Current (DC)	IF	30	mA
Peak Forward Current *	IFP	100	mA
Reverse Voltage	VR	5	V
Operating Temp.	Topr	-30 ~ +80	°C
Storage Temp.	Tstg	-40 ~ +100	°C
Lead Soldering Temperature	Tsol	Max. 260°C for 5 sec Max. (3mm from the epoxy body)	

* Pulse width ≤ 0.1 msec. duty $\leq 1/10$

■ Electro-optical Characteristics

(Ta=25°C)

Parameter	Symbol	Min.	Typ.	Max.	Unit	Condition
Forward Voltage	VF	-----	2.1	2.6	V	IF=20mA
Luminous Intensity	Iv	3900	6600	-----	mcd	
Dominant Wavelength	λD	-----	590	-----	nm	
Viewing Angle	2 θ 1/2	-----	30	-----	deg	
Reverse Current	IR	-----	-----	50	μ A	VR=5V



Model No : CSLR-U305YL4-B0

■ Luminous Intensity Rank Limits ($I_f = 20\text{mA}$)

unit : mcd

Part No. Code	CSLR-U305YL4-B0	
	min.	max.
T	3900	5100
U	5100	6600
V	6600	8600
W	8600	11200
X	11200	14600

■ Dominant Wavelength Rank Limits ($I_f = 20\text{mA}$)

unit : nm

Part No. Code	CSLR-U305YL4-B0	
	min.	max.
Y3	589.5	592
Y4	592	594.5
Y5	594.5	597

■ Forward Voltage Rank Limits ($I_f = 20\text{mA}$)

unit : v

Part No. Code	CSLR-U305YL4-B0	
	min.	max.
B	1.6	1.8
C	1.8	2.0
D	2.0	2.2
E	2.2	2.4
F	2.4	2.6

Notes:

1. Tolerance of measurement of luminous intensity :±15%
2. Tolerance of measurement of Color Coordinates :±0.01
3. Tolerance of measurement of forward voltage :±0.05v
4. All data are measured by CSC's test equipment.
5. One delivery will include several color rank, VF rank and Iv ranks of the products.
6. The quantity-ratio of the ranks is decided by CSC.
7. Please confirm with CSC salesman,if your request different form standard specification.



Model No : CSLR-U305YL4-B0

■ Typical Electrical / Optical Characteristics Curves -

(Ta = 25°C Unless Otherwise Noted)

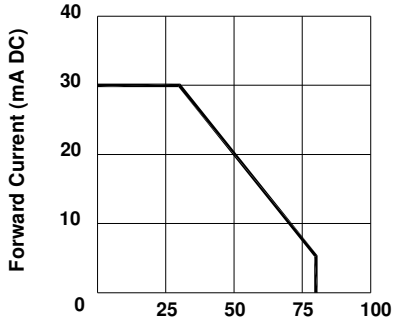

Ambient Temperature Ta (°C)
Fig 1. Forward Current
Vs. Ambient Temperature

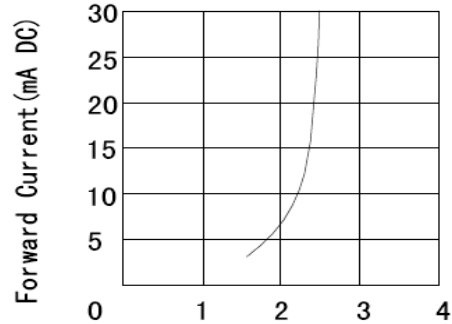

Forward Voltage VF (V)
Fig. 2 Forward Current
Vs. Forward Voltage

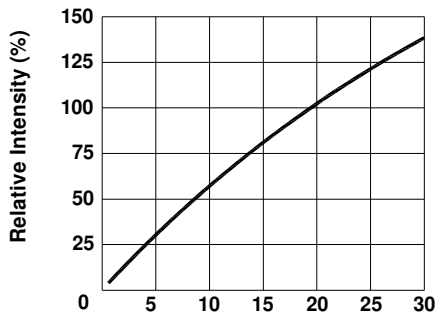

Forward Current IF (mA DC)
Fig 3. Relative Intensity
Vs. Forward Current

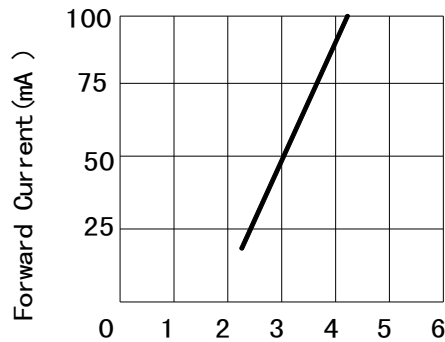

Forward Voltage (V)
Fig. 4 Peak Forward Voltage
Vs. Forward Current
(100us test pulse, 1% duty cycle)

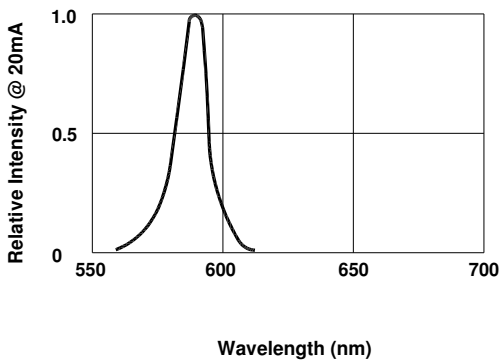

Fig 5. Relative Intensity Vs. Wavelength

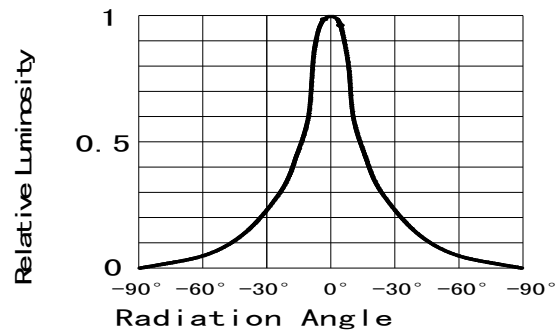
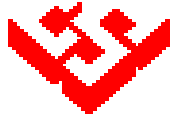

Fig 6. Relative Luminous Intensity vs. Radiation Angle



Model No : CSLR-U305YL4-B0

■ Precautions For Use -

1. Recommended Soldering conditions

Wave Soldering

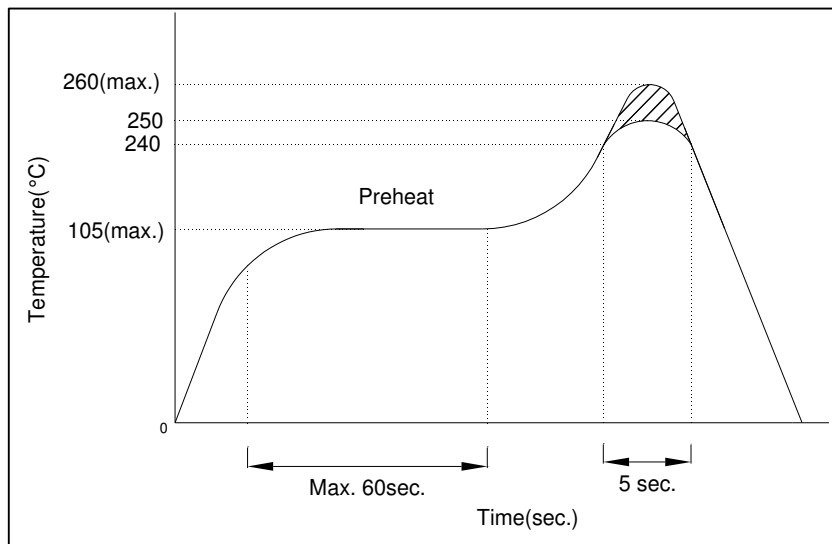

2. Soldering Iron

Basic SPEC. is ≤ 5 sec. When 260°C . If temperature is higher, time should be shorter ($+10^{\circ}\text{C} \rightarrow -1$ sec.). Power dissipation of iron should be smaller than 15W, and temperature should be controllable. Surface temperature of the device should be under 230°C .

3. Static Electricity

- a. Static electricity or surge voltage damages LEDs..

It is recommended that a wrist band or an anti-electrostatic glove be used when handling the LEDs.

- b. All devices, equipment and machinery must be properly grounded. It is recommended that measures be taken against surge voltage to the equipment that mounts the LEDs.

Note: The specifications are subject to change without notice. Please contact us for updated information.