

Specification

SPT15P

All exposed cast aluminum components are made of non corrosive pure aluminum copper free (Aluminum is less than .1% copper content.#356 alloy.)

Finish: All polyester powder baked coatings preceded with a 5 baths preparation process. Meets military grade MIL-C781706 with a 2000 hours salt spray test.

- Pulse rated medium base porcelain socket.
- 75W/600V thermoplastic compact fluorescent socket.
- One-piece molded silicone gasket with memory retention.
- High power factor CWA ballast. Or 98% P.F.electronic smart ballast with end of life detection for compact fluorescent.
- All stainless steel hardware.
- All Moving and removable parts are sealed with a memory retention silicone gasket.
- Cast aluminum swing out hinge mechanism for quick maintenance access.

- 1 - 3/16" Thick aluminum outer reflector disc with a 360° horizontal rotation center light directional disc allowing up to 30° tilting position, with a set of cast aluminum locking clamps. Textured white standard finish on both faces.
- 2 - Set of 2 cast aluminum elliptically shaped curved arms.
- 3 - Cast aluminum sealed hinged lens frame, with perimeter memory retention embedded silicone gasket.
- 5 - One piece cast aluminum lamp and ballast housing.
- 4 - Tempered clear glass lens.
- 6 - Standard semi-specular reflector.

SPT15P: Outer reflector disc with central rotation/tilt disc.
SPT15PF: One piece solid horizontal factory fixed reflector disc.
SPT15P15: One piece solid 15° tilt factory fixed reflector disc.

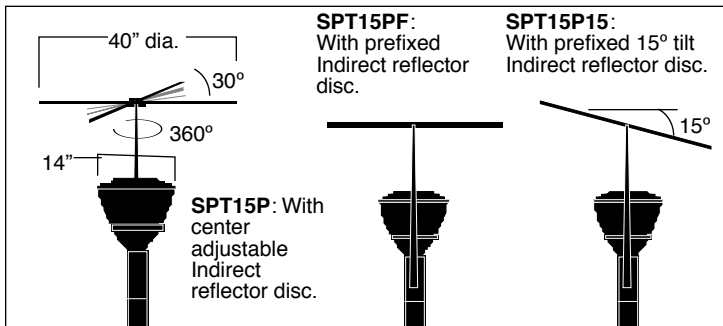
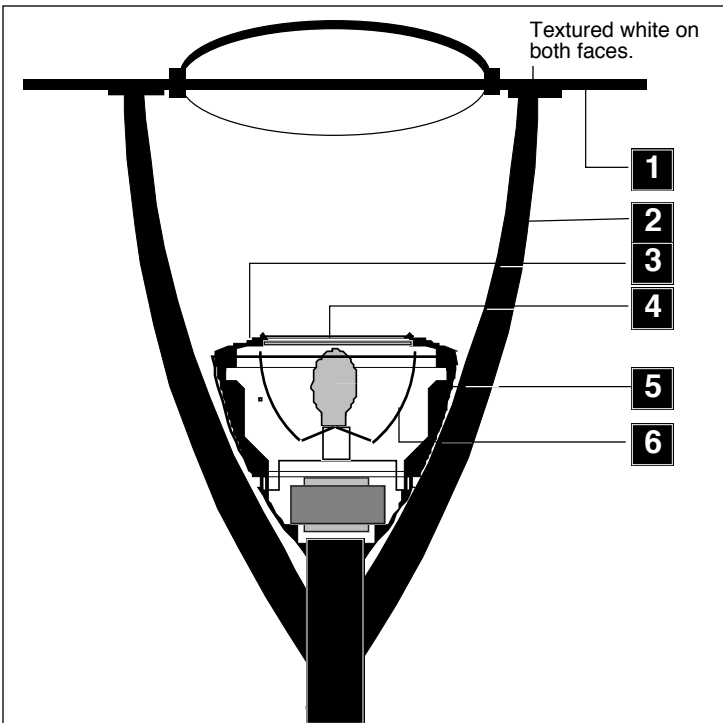

Photometry

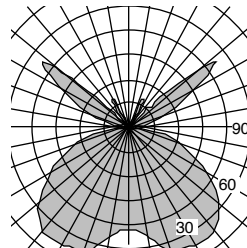

Separate updated technical specification sheets with related models and light sources with I.E.S formatted photometry are available on www.luminis.com.

For options details and specifications, please refer to pages 115.116 & 72

Certification Mounting / E.P.A

UL. Wet Location. E.P.A : 1.81
 Installation: fits with a 4" O.dia. x 0.226 Thick wall pole .Refer to separate pole section .

| Model# | Light source selection | Voltage | Finish | Options |
|--|---|--|---|--|
| <input type="checkbox"/> SPT15P <input type="checkbox"/> SPT15PF <input type="checkbox"/> SPT15P15 | <div style="display: flex; justify-content: space-between;"> <div style="width: 45%;"> <p>MH (ED17)</p> <p><input type="checkbox"/> M100</p> <p><input type="checkbox"/> M150</p> <p><input type="checkbox"/> M175</p> <p><input type="checkbox"/> M250 (ED28) *</p> <p>HPS (ED17)</p> <p><input type="checkbox"/> H100 (ED17)</p> <p><input type="checkbox"/> H150 (ED17)</p> <p><input type="checkbox"/> H250 (ED28) *</p> </div> <div style="width: 45%;"> <p>MH (G12) T6</p> <p><input type="checkbox"/> M70T</p> <p><input type="checkbox"/> M150T</p> <p>* M250 & H250 are compatible with a 5" O.D. pole only.</p> </div> </div> <p>(Lamps by others)</p> | <p>120 V Standard factory prewired (If no voltage is specified)</p> <p>For other voltages, please specify with catalog number.</p> <p>H.I.D.</p> <p><input type="checkbox"/> 208 V</p> <p><input type="checkbox"/> 240 V</p> <p><input type="checkbox"/> 277 V</p> <p><input type="checkbox"/> 347 V</p> <p><input type="checkbox"/> 480 V</p> | <p>(Refer to color chart)</p> <p><u>Standard selection</u></p> <p><input type="checkbox"/> WHT: Snow white</p> <p><input type="checkbox"/> BKT: Jet black</p> <p><input type="checkbox"/> BZT: Bronze</p> <p><input type="checkbox"/> GRT: Titanium gray</p> <p><input type="checkbox"/> DGT: Gun metal</p> <p><input type="checkbox"/> CHT: Champagne</p> <p><input type="checkbox"/> MST: Matte silver</p> <p><input type="checkbox"/> GNT: Forest green</p> <p><u>Optional colors</u></p> <p><input type="checkbox"/> CS: Custom color</p> <p><input type="checkbox"/> RAL: RAL# color</p> | <p>Electrical</p> <p><input type="checkbox"/> FS: Fuse</p> <p><input type="checkbox"/> PH1: 120/277V photo cell</p> <p><input type="checkbox"/> PH2: 347V photo cell</p> |

luminaires may be altered for design improvements or discontinued without prior notice.

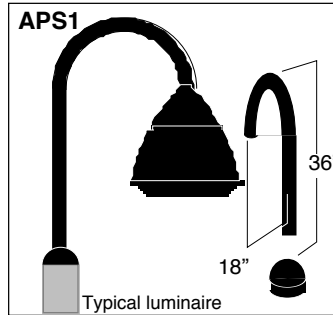
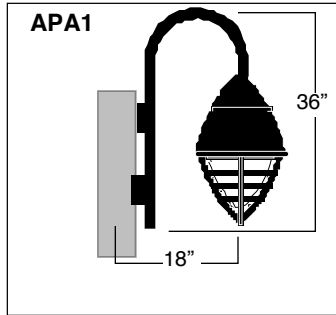
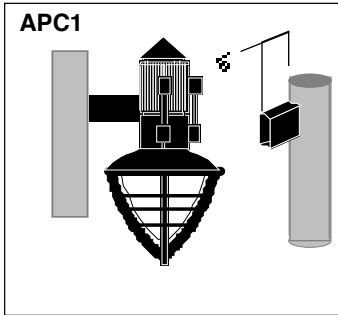

General note:
SPT20-SPT25 and SPT50 are designed as luminaire modules adaptable to various installation requirements as a pole ceiling or wall mount. Please specify the selected type of attachment with model number. (Refer to page 116 for additional pole mounting information.)

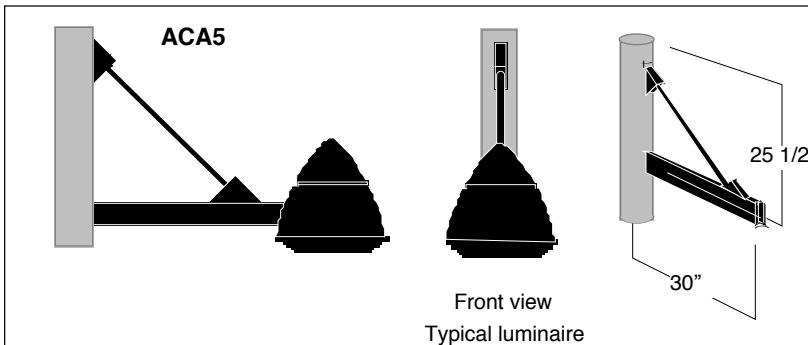
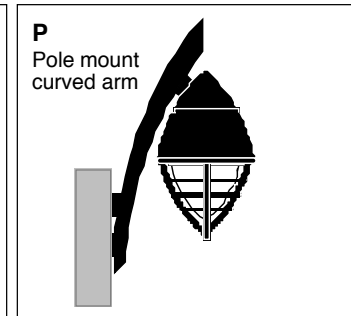
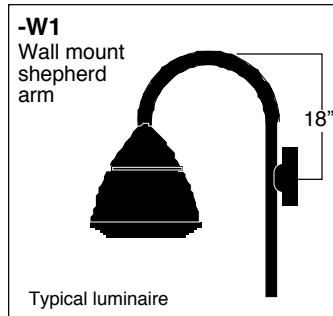
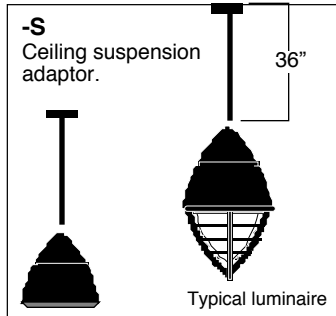
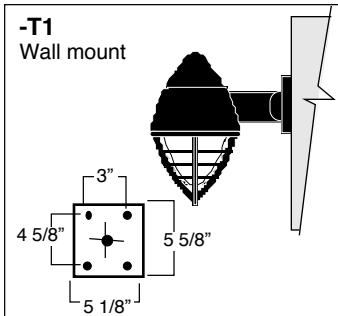

ACA5 -EPA: 0.8
1" X 3" extruded aluminum side pole arm mount. 4" O.D X 30" lg. post top adaptor with a cast aluminum tenon to fit with a 3 3/4" I.D. pole. 1/2" dia. stainless steel rod support. Extruded arm and all other parts are painted same color as Luminaire.

ACW5- Wall mount version with independent cast aluminum mounting plates.

APC1 -EPA: 0.12
1" X 3" extruded aluminum side pole mounting adaptor.

APA1 - EPA: 0.2
1 5/8" dia. aluminum shepherd style arm, with two extruded 1"X 3" aluminum side pole adaptor.

APS1 - EPA: 0.15
1 5/8" dia. aluminum shepherd style arm, with two extruded 1"X 3" aluminum pole adaptor.

-S
15° swivel ceiling mount with 5/8" dia. X36"lg aluminum stem. luminaire top adaptor allowing to cut stem to length on site.
(Mounts over a standard 4" octagonal box with 3 1/2" C/C holes)

-T1 -1" x 3" extruded aluminum wall mounting straight adaptor with cast aluminum cover and galvanized steel mounting plate.

-W1 -1 5/8" Dia. shepherd aluminum arm wall mount, with a cast aluminum wall cover and galvanized steel mounting plate.

-P - Cast aluminum elliptical curved arm. Refer to corresponding luminaire specification sheet SPT20 & SPT25 for details.

BI-LEVEL MOUNTING

Option: BL
Twin mount off set luminaire installation.

Step1:
Select distance between luminaires as shown("X")
1) BL ("X")

Step2:
Indicate position of luminaires at 90° or 180°
2) (P)-Position

EX: SPT20-BL36-90

Important: consider Additional pole length required for BL set mounting.

Spartacus SPT20 and SPT25 series may be installed in several positions along the pole. Please provide information with desired position as shown above.

luminaires may be altered for design improvements or discontinued without prior notice.

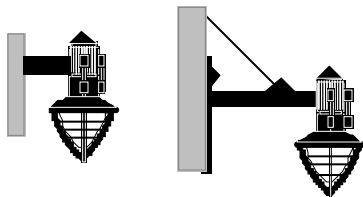
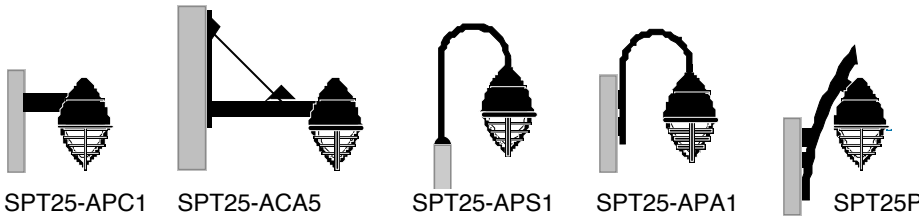
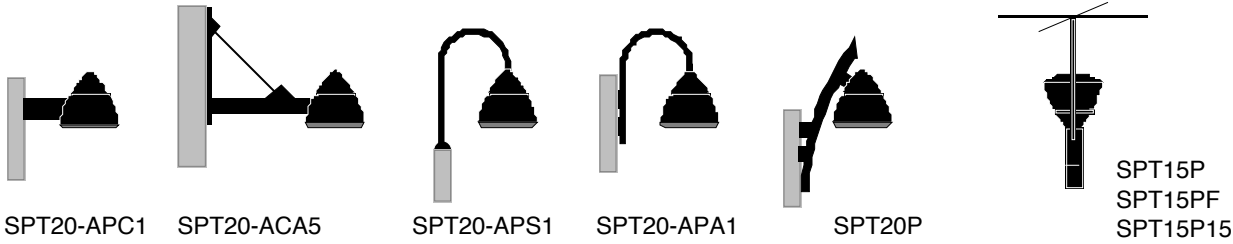

SPT50-APC1 SPT50-ACA5

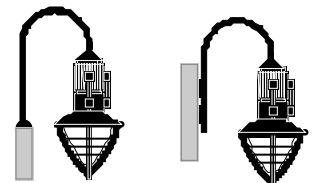

SPT50-APS1 SPT50-APA1

* Note:
36" extension with ACA5 attachment
24" extension with APA1 & APC1 attachment

Mounting style



-APA1 Mounting



-APC1 Mounting

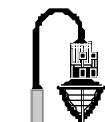

-APS1 Mounting

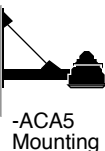

-ACA5 Mounting

PEX pole style PXD pole style PCA pole style PCA pole style PAA pole style

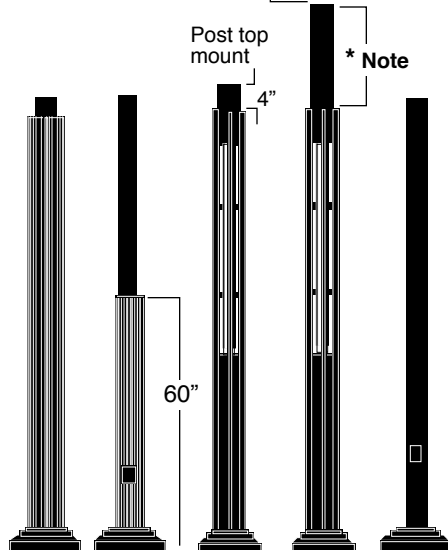

Note:
PAA4 series
PCA
PXD
Poles
up to 175W
luminaires

PAA5 series
up to 250W
luminaires

Compatible poles listing.

Post side mount with APA1 attachment accessory

| 4" O.D. | 5" O.D. | 4" O.D. | 4" O.D. | Pole height |
|------------|------------|-----------|-----------|-------------|
| PAA410-APA | PAA510-APA | | PXD10-APA | 10 ft |
| PAA412-APA | PAA512-APA | PCA12-APA | PXD12-APA | 12 ft |
| PAA414-APA | PAA514-APA | PCA14-APA | PXD14-APA | 14 ft |
| PAA416-APA | PAA516-APA | PCA16-APA | PXD16-APA | 16 ft |
| PAA418-APA | PAA518-APA | | PXD18-APA | 18 ft |
| PAA420-APA | PAA520-APA | | PXD20-APA | 20 ft |

Post side mount with APC1 attachment accessory

| | | | | |
|------------|------------|-----------|-----------|-------|
| PAA410-APC | PAA510-APC | | PXD10-APC | 10 ft |
| PAA412-APC | PAA512-APC | PCA12-APC | PXD12-APC | 12 ft |
| PAA414-APC | PAA514-APC | PCA14-APC | PXD14-APC | 14 ft |
| PAA416-APC | PAA516-APC | PCA16-APC | PXD16-APC | 16 ft |
| PAA418-APC | PAA518-APC | | PXD18-APC | 18 ft |
| PAA420-APC | PAA520-APC | | PXD20-APC | 20 ft |

Post top mount with APS1 attachment accessory

| | | | | |
|----------|-----------|---------|---------|-------|
| PAA410-A | PAA510-A1 | PCA10-A | PXD10-A | 10 ft |
| PAA412-A | PAA512-A1 | PCA12-A | PXD12-A | 12 ft |
| PAA414-A | PAA514-A1 | PCA14-A | PXD14-A | 14 ft |
| PAA416-A | PAA516-A1 | PCA16-A | PXD16-A | 16 ft |
| PAA418-A | PAA518-A1 | | PXD18-A | 18 ft |
| PAA420-A | PAA520-A1 | | PXD20-A | 20 ft |

Post side mount with ACA5 attachment accessory

| | | | | |
|------------|------------|-----------|-----------|-------|
| PAA414-ACA | PAA514-ACA | PCA14-ACA | PXD14-ACA | 14 ft |
| PAA416-ACA | PAA516-ACA | PCA16-ACA | PXD16-ACA | 16 ft |
| PAA418-ACA | PAA518-ACA | | PXD18-ACA | 18 ft |
| PAA420-ACA | PAA520-ACA | | PXD20-ACA | 20 ft |

Post top mount

| | | | | |
|----------|-----------|---------|---------|-------|
| PAA410-A | PAA510-A2 | | PXD10-A | 10 ft |
| PAA412-A | PAA512-A2 | | PXD12-A | 12 ft |
| PAA414-A | PAA514-A2 | PCA14-A | PXD14-A | 14 ft |
| PAA416-A | PAA516-A2 | PCA16-A | PXD16-A | 16 ft |
| PAA418-A | PAA518-A2 | | PXD18-A | 18 ft |
| PAA420-A | PAA520-A2 | | PXD20-A | 20 ft |

For poles details and specification, please refer to pages 140 to 144

Luminaires may be altered for design improvements or discontinued without prior notice.