

1. PART NO. EXPRESSION :

S D B 1 2 0 4 3 R 3 M Z F
 (a) (b) (c) (d)(e)(f)

- (a) Series code
- (b) Dimension code
- (c) Inductance code : 3R3 = 3.3uH
- (d) Tolerance code : M = ±20%
- (e) X, Y, Z : Standard part
- (f) F : Lead Free

2. CONFIGURATION & DIMENSIONS :

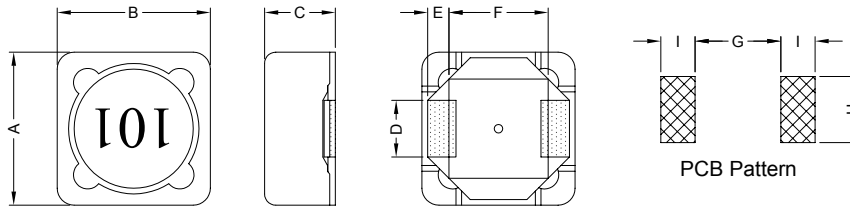

Unit:m/m

A	B	C	D	E	F	G	H	I
12.5±0.3	12.5±0.3	4.60 Max.	5.0±0.2	2.2±0.2	7.6±0.2	7.0 Ref.	5.4 Ref.	2.8 Ref.

3. SCHEMATIC :

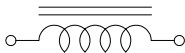

4. MATERIALS :

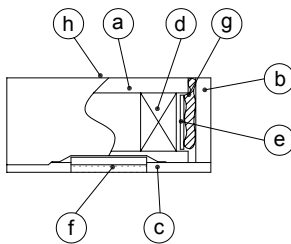

- (a) Core : DR Ferrite Core
- (b) Core : SI Ferrite Core
- (c) Base : LCP
- (d) Wire : Enamelled Copper Wire
- (e) Tape : Mylar Tape
- (f) Terminal : Tinned Copper Wire
- (g) Adhesive : Epoxy
- (h) Ink : Bon Margue

5. GENERAL SPECIFICATION :

- a) Temp. rise : 40°C Max.
- b) Rated current : Base on temp. rise & ΔL/L0A = 20% Max.
- c) Storage temp. : -40°C to +125°C
- d) Operating temp. : -40°C to +80°C
- e) Resistance to solder heat : 260°C.10secs



RoHS Compliant

NOTE : Specifications subject to change without notice. Please check our website for latest information.



6. ELECTRICAL CHARACTERISTICS :

Part No.	Inductance (μ H)	Test Frequency (Hz)	RDC (m Ω) Max.	IDC (A) Max.
SDB12043R3MZF	3.3 \pm 20%	1V / 100K	15	6.50
SDB12044R7MZF	4.7 \pm 20%	1V / 100K	18	5.70
SDB12046R8MZF	6.8 \pm 20%	1V / 100K	23	4.90
SDB1204100MZF	10.0 \pm 20%	1V / 100K	28	4.50
SDB1204120MZF	12.0 \pm 20%	1V / 100K	38	4.00
SDB1204150MZF	15.0 \pm 20%	1V / 100K	52	3.20
SDB1204180MZF	18.0 \pm 20%	1V / 100K	60	3.10
SDB1204220MZF	22.0 \pm 20%	1V / 100K	70	2.90
SDB1204270MZF	27.0 \pm 20%	1V / 100K	80	2.80
SDB1204330MZF	33.0 \pm 20%	1V / 100K	97	2.70
SDB1204390MZF	39.0 \pm 20%	1V / 100K	132	2.10
SDB1204470MZF	47.0 \pm 20%	1V / 100K	150	1.90
SDB1204560MZF	56.0 \pm 20%	1V / 100K	190	1.80
SDB1204680MZF	68.0 \pm 20%	1V / 100K	220	1.50
SDB1204820MZF	82.0 \pm 20%	1V / 100K	260	1.30
SDB1204101MZF	100.0 \pm 20%	1V / 100K	308	1.20
SDB1204121MZF	120.0 \pm 20%	1V / 100K	380	1.10
SDB1204151MZF	150.0 \pm 20%	1V / 100K	520	0.95
SDB1204181MZF	180.0 \pm 20%	1V / 100K	600	0.85
SDB1204221MZF	220.0 \pm 20%	1V / 100K	700	0.80
SDB1204271MZF	270.0 \pm 20%	1V / 100K	860	0.60
SDB1204331MZF	330.0 \pm 20%	1V / 100K	980	0.50



RoHS Compliant

NOTE : Specifications subject to change without notice. Please check our website for latest information.

07.05.2008



SUPERWORLD ELECTRONICS (S) PTE LTD

PG. 2

7. CHARACTERISTICS CURVES :

@ TEMP. RISE VS. DC SUPERPOSITION RESPONSE CURVE

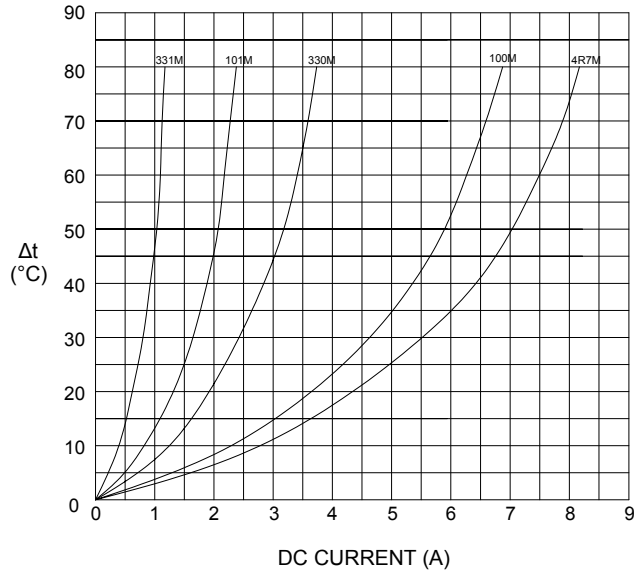

@ INDUCTANCE VS. FREQUENCY RESPONSE CURVE

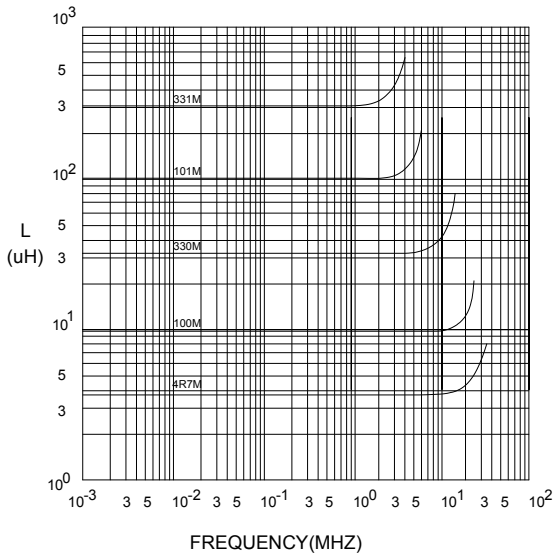

@ INDUCTANCE VS. DC SUPERPOSITION RESPONSE CURVE

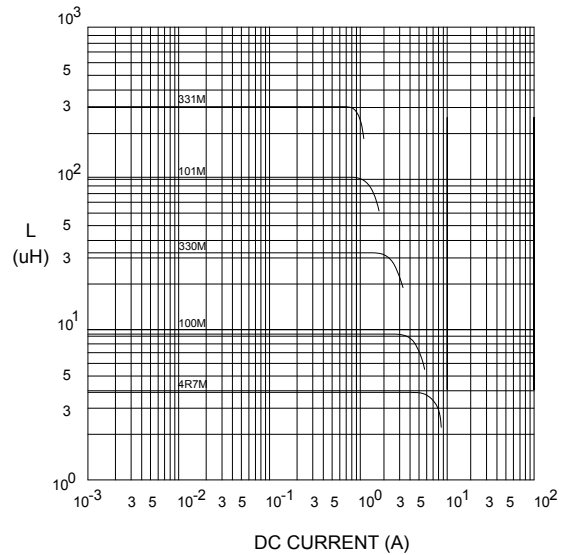

NOTE : Specifications subject to change without notice. Please check our website for latest information.



RoHS Compliant

07.05.2008



SUPERWORLD ELECTRONICS (S) PTE LTD

RECOMMENDED SOLDERING CONDITIONS REFLOW SOLDERINGS

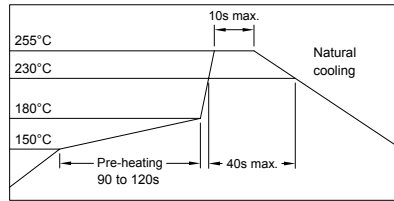

8. PACKAGING INFORMATION :

(1) CONFIGURATION

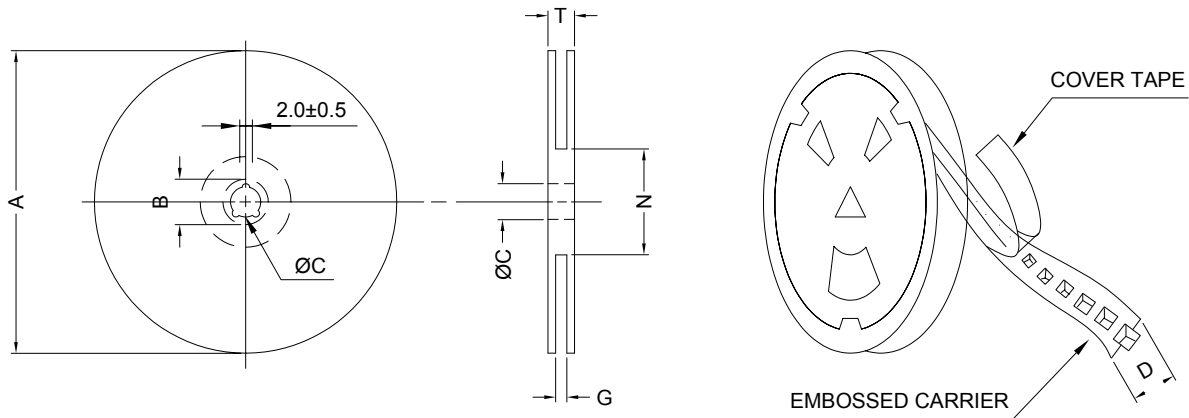

* CARRIER TAPE WIDTH : D

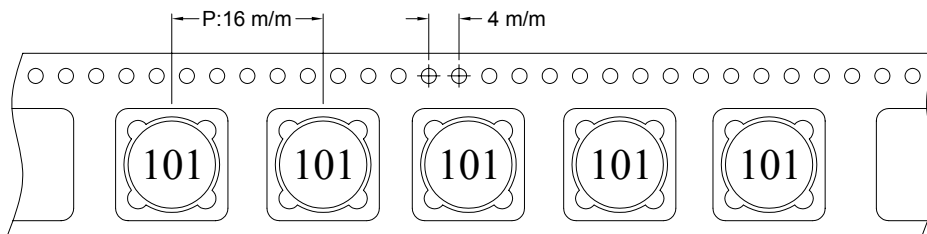

(2) DIMENSIONS

Unit:m/m

STYLE	A	B	C	D	G	N	T
13-24	330	21±0.8	13±0.5	24	26 ⁺⁰	50 ⁻⁰	30.4

(3) Q'TY & G.W. PER PACKAGE

SERIES	INNER : REEL			OUTER : CARTON		
	Q'TY (PCS)	G.W. (gw)	STYLE	Q'TY (PCS)	G.W. (Kg)	SIZE (cm)
SDB1204	600	1900	13-24	2400	11.1	40 x 40 x 24



RoHS Compliant

NOTE : Specifications subject to change without notice. Please check our website for latest information.

07.05.2008



SUPERWORLD ELECTRONICS (S) PTE LTD

9. RELIABILITY AND TEST CONDITION :

TEST ITEM	SPECIFICATION	TEST CONDITION
SOLDERABILITY	MORE THAN 90% OF THE TERMINAL ELECTRODE SHALL BE COVERED WITH FRESH SOLDER.	PREHEAT : 125±25°C FOR 60 SECONDS SOLDER : 99%Sn/0.3%Ag/0.7%Cu OR EQUIVALENT SOLDER TEMP. : 245±5°C FLUX : ROSIN DIP TIME : 4±1 SECONDS
THERMAL SHOCK TEST (TEMP. CYCLE)	INDUCTANCE SHALL NOT CHANGE MORE THAN ±20%	ROOM TEMP. → -25±2°C 15 MINUTES → 30 MINUTES ROOM TEMP. → 85±2°C 15 MINUTES → 30 MINUTES TOTAL : 50 CYCLES
HUMIDITY RESISTANCE TEST		TEMPERATURE : 40±2°C HUMIDITY : 90 ~ 95% APPLIED CURRENT : PER SPEC. TIME : 500 HOURS
HIGH TEMP. RESISTANCE TEST		TEMPERATURE : 85±2°C APPLIED CURRENT : PER SPEC. TIME : 500 HOURS



RoHS Compliant

NOTE : Specifications subject to change without notice. Please check our website for latest information.

07.05.2008



SUPERWORLD ELECTRONICS (S) PTE LTD

10. UL CARD :

OBMW2 **November 30, 2000**
Magnet Wire - Component

PACIFIC ELECTRIC WIRE & CABLE (SHENZHEN) CO LTD **E201757**
607 BAOLONG INDUSTRIAL ESTATE LONGGANG, SHENZHEN
GUANGDONG CHINA

Mtl Dsg	BC	Coating Type	TC	ANSI Type	TI
UEW/U		Polyurethane	—	—	130
PEW/U		Polyester	—	MW5-C	155°C
PEWH/U		Modified Polyester	—	MW30-C	180
PEW-NY/U		Polyester	Polyamide	MW24-C	155
HAI/U		Polyester(Amide)(Imide)	Polyamideimide	MW35,73	200
UEW-NY/U		Polyurethane	Polyamide	MW80-C	155
				MW28-C	130

Marking: Company name and material designation or marked designation on package or reel, and Recognized Component Mark.

See General Information Preceding These Recognitions

1/3/2001 **Underwriters Laboratories Inc.** **Card 1 of 2**

SUMITOMO CHEMICAL CO LTD **E54705 (M)**
5-33 KITAHAMA 4-CHOME CHUO-KO, OSAKA JAPAN

Mtl Dsg	Col	Min Thk mm	UL94 Flame Class	Elec	RTI		H W I	H A I	H V T R	D 4 9 5	C T I
					with Imp	w/o Imp					
Liquid crystal polyester (LCP), designated "EKONOL" or "SUMIKASUPER", furnished in the form of pellets, (Contd)											
E4008, E400X	NC, BK	0.30	94V-0	130	130	130	—	—	—	—	—
		0.75	94V-0	130	130	130	3	4	—	—	—
		1.5	94V-0	130	130	130	2	4	—	—	—
		3.0	94V-0	130	130	130	1	4	0	5	4
E4008	NC, WT, BK	0.30	94V-0	130	130	130	—	—	—	—	—
		0.75	94V-0	220	180	220	3	4	—	—	—
		1.5	94V-0	220	200	240	2	4	—	—	—
		3.0	94V-0	220	200	240	1	4	0	5	4
E4010	NC, BK	0.30	94V-0	130	130	130	—	—	—	—	—
		0.75	94V-0	220	180	220	3	4	—	—	—
		1.5	94V-0	220	200	240	2	4	—	—	—
		3.0	94V-0	220	200	240	1	4	0	5	4
E400(Y)L, E4008L	NC, BK	0.30	94V-0	130	130	130	—	—	—	—	—
		0.75	94V-0	130	130	130	3	4	—	—	—
		1.5	94V-0	130	130	130	2	4	—	—	—
		3.0	94V-0	130	130	130	1	4	0	5	4
E4810	NC, BK	0.30	94V-0	130	130	130	—	—	—	—	—
		0.75	94V-0	130	130	130	0	4	—	—	—
		1.5	94V-0	130	130	130	0	4	—	—	—
		3.0	94V-0	130	130	130	1	4	0	5	4

(X) Denotes any number 1 thru 9.
(Y) Denotes any number 1 thru 7.



RoHS Compliant

NOTE : Specifications subject to change without notice. Please check our website for latest information.

07.05.2008



SUPERWORLD ELECTRONICS (S) PTE LTD

10. UL CARD :

<p>TERAOKA SEISAKUSHO CO LTD 4-22 1-CHOME HIROMACHI SHINAGAWA-KU, TOKYO JAPAN</p> <p>Flame retardant aramid paper tape, Cat. Nos. 512F+, 560F+, 565S+, 681S+. Flame retardant aramid paper tape, Cat. Nos. 560S+, 561S+, 562S+, rated 200 C. Flame retardant acetate cloth tape, Cat. Nos. 570F+, 571F+, 573F+. Flame retardant polyester film tape, Cat. Nos. 680F+, 684F+. Flame retardant glass cloth tape, Cat. Nos. 510F+, 540S+, 541F+, 685S+. Flame retardant glass cloth tape, Cat. No. 54S, rated 200 C. Flame retardant cotton cloth tape, Cat. Nos. 590F+, 715F+. Flame retardant polyimide film tape, Cat. No. 650S+, rated 200 C. Flame retardant tellon tape, Cat. Nos. 841+, 846+. Flame retardant PVC tape, Cat. Nos. 305F+, 307F+, 380F+. Flame retardant polyester fiber tape, Cat. Nos. 511F+, 551F+. Flame retardant epoxy varnish impregnated polyester web tape, Cat. Nos. 530F+. Flame retardant epoxy varnish impregnated glass paper tape, Cat. No. 531F+. Flame retardant copper foil tape, Cat. No. 831S+. Flame retardant copper foil tape, Cat. No. 8321+. Flame retardant aluminum foil tape, Cat. Nos. 833+, 834+. Epoxy varnish impregnated polyester non-woven fabric tape, cat. no. 530F° rated 150 C. polyester film tape, Cat. Nos. 631S°, 632S, rated 130 C. Flame retardant polyester film tape, Cat. No. 630F°, rated 130 C. Flame retardant polyester film/epoxy varnish impregnated polyester fiber tape Cat. No. 673F°, rated 130 C. Flame retardant polyester film/epoxy varnish impregnated polyester fiber/polyester film tape, Cat. No. 850F°, rated 130 C. + - Subjected to Flame Retardant tests only. ° - Complies with Flame Retardant requirements when so marked. Marking: Company name or "E56086" and catalog designation and "Flame Retardant" if applyce, bie. printed on the central paper or outer package.</p>	<p>E56086 (S)</p>
-------------------------------------------------------------------------------------------------------------------------------------------------------------------------------------------------------------------------------------------------------------------------------------------------------------------------------------------------------------------------------------------------------------------------------------------------------------------------------------------------------------------------------------------------------------------------------------------------------------------------------------------------------------------------------------------------------------------------------------------------------------------------------------------------------------------------------------------------------------------------------------------------------------------------------------------------------------------------------------------------------------------------------------------------------------------------------------------------------------------------------------------------------------------------------------------------------------------------------------------------------------------------------------------------------------------------------------------------------------------------------------------------------------------------------------------------------------------------------------------------------------------------------------------------------------------------------------------------------------------------------------------------------------------------------------------------------------------------------------------------------------------------------------------------------------------------------------------------------------------------------------------------------------------------------------------------------------------------------	-------------------

<p>OANZ2 August 7, 1989 Component-Insulating Tape</p> <p>FOUR PILLARS ENTERPRISE CO LTD E50292 (S) NO 18 HENGYANG RD , TAIPEI TAIWAN (A card)</p> <p>Flame retardant polyvinyl chloride tape, Cat. No. 33047+. Polyester film tape, Cat. No. 35660° rated 130C. Flame retardant double sided acrylic tape, Cat. No. DS31+. Arme paper tape, Cat. No. NM130° rated 155C. Glass cloth backing with silicone adhesive, Cat. No. GL06° rated 180C. Glass cloth backing with acrylic adhesive, Cat. No. GL15 rated 155C. Glass cloth backing with rubber adhesive, Cat. No. GL27 rated 130C. Polyesterfilm insulating tape with acrylic adhesive, Cat. No. MY130 rated 130C. Polyesterfilm insulating tape with silicone base adhesive, Cat. No. KA180° rated 180C. Acetate cloth backing with acrylic base adhesive, Cat. No. AC0 rated 130C.</p> <p>Reports: March 25, 1985; March 26, 1985; March 27, 1985; March 7, 1986; July 2, 1987; July 2, 1987; July 2, 1987; March 9, 1989; March 10, 1989; August 15, 1989.</p> <p>Replaces E50292A dated Febuary 28, 1989. (Cont. on B card) 369021002 Underwriters Laboratories Inc.® D11/0114874 51</p>



RoHS Compliant

NOTE : Specifications subject to change without notice. Please check our website for latest information.

07.05.2008



SUPERWORLD ELECTRONICS (S) PTE LTD