

## SMT15F Series

### 12 Vin single fixed output

**Total Power:** 15.0 W  
**Input Voltage:** 10.8-13.2 Vdc  
**# of Outputs:** Single

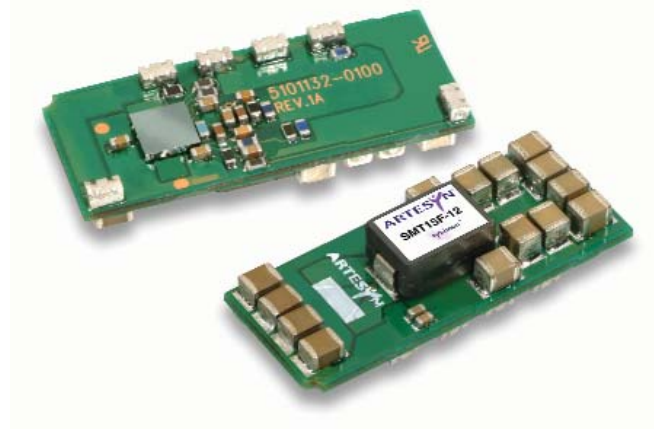

## Special Features

- Designed to meet ultra fast transient requirements: 300 A/ $\mu$ s step load transients
- 15 A Current rating
- Input voltage range: 10.8 Vdc to 13.2 Vdc
- Output voltage range: 1.0 Vdc to 1.8 Vdc
- Extremely low internal power dissipation
- Minimal thermal design concerns
- Ideal solution where board space is at a premium or tighter card pitch is required
- Industry standard surface-mount footprint
- Available RoHS compliant
- 2 year warranty

## Safety

UL/cUL CAN/CSA 22.2  
No. E174104  
UL 60950 File No. E174104

TÜV Product Service (EN60950)  
Certificate No. B 04 04 38572

CB report and certificate to  
IEC60950 DE3-52484

The SMT15F-12 series are non-isolated dc-dc converters packaged in a surface-mount footprint giving designers a cost effective solution for conversion from a 12 V source. The SMT15F-12 has an input range of 10.8 Vdc to 13.2 Vdc and offers an output voltage range from 1.0 Vdc to 1.8 Vdc with a 15 A load, which allows for maximum design flexibility and a pathway for future upgrades. The SMT15F-12 is designed for applications that include distributed power, workstations, optical network and wireless applications. Implemented using state of the art surface-mount technology and automated manufacturing techniques, the SMT15F-12 offers compact size and efficiencies of up to 88% at 1.8 Vout.



# Specifications

All specifications are typical at nominal input, full load at 25°C unless otherwise stated.

OUTPUT SPECIFICATIONS		
Voltage adjustability	(Trimmable)	±10%
Setpoint accuracy		±2.5% typ.
Line regulation		±1.0% typ.
Load regulation		±1.0% typ.
Total error band		±3.0% typ.
Minimum load		0 A
Overshoot/undershoot		None
Ripple and noise	5 Hz to 20 MHz	40 mV pk-pk 25 mV rms
Temperature co-efficient		±0.01%/°C
Transient response (1.2 Vout)	di/dt 200 A/μs (See Note 3)	7.5 A load step 50 mV max. deviation <10 μs recovery to within ±1.0%
Remote sense		10% Vo compensation
INPUT SPECIFICATIONS		
Input voltage range		10.8 Vdc to 13.2 Vdc
Input current	No load	100 mA
Input current (max.)		2.0 A max. @ Io max. and Vout = 1.2 V
Input reflected ripple		100 mA rms
Remote ON/OFF		(See Note 1)
Start-up time		5 ms

EMC CHARACTERISTICS		
Electrostatic discharge		EN61000-4-2, IEC801-2
Conducted immunity		EN61000-4-6
Radiated immunity		EN61000-4-3
GENERAL SPECIFICATIONS		
Efficiency	Vin = 12 V, Vout = 1.8 V	88% typ.
Insulation voltage		Non-isolated
Switching frequency	Variable	700 kHz typ.
Vin = 12 V, Vout = 1.2 V		
Approvals and standards		EN60950 UL/cUL60950
Material flammability		UL94V-0
Dimensions	(LxWxH)	33.02 x 13.46 x 7.57 mm 1.3 x 0.53 x 0.298 inches
Weight		7 g (0.25 oz)
Coplanarity		100 μm
MTBF	Telcordia SR-332	16,529,000 hours

ENVIRONMENTAL SPECIFICATIONS		
Thermal performance (See Figure 1)	Operating ambient, temperature Non-operating	-40 °C to +85 °C -40 °C to +125 °C
PROTECTION		
Short-circuit		Continuous
Thermal		Automatic recovery

# Specifications

Rev.06.27.07  
Rev.06.28.07  
SMT15F\_12\_FIXED  
3 of 5

All specifications are typical at nominal input, full load at 25°C unless otherwise stated.

OUTPUT POWER (MAX.)	INPUT VOLTAGE	OUTPUT VOLTAGE	OUTPUT CURRENT (MIN.)	OUTPUT CURRENT (MAX.)	EFFICIENCY (TYP.)	REGULATION		MODEL NUMBER <sup>(1,4,5)</sup>
						LINE	LOAD	
15.0 W	10.8-13.2 Vdc	1 Vdc	0 A	15 A	85%	±1.0%	±1.0%	SMT15F-12S1V0J
18.0 W	10.8-13.2 Vdc	1.2 Vdc	0 A	15 A	86%	±1.0%	±1.0%	SMT15F-12S1V2J
22.5 W	10.8-13.2 Vdc	1.5 Vdc	0 A	15 A	87%	±1.0%	±1.0%	SMT15F-12S1V5J
27.0 W	10.8-13.2 Vdc	1.8 Vdc	0 A	15 A	88%	±1.0%	±1.0%	SMT15F-12S1V8J

## Part Number System with Options

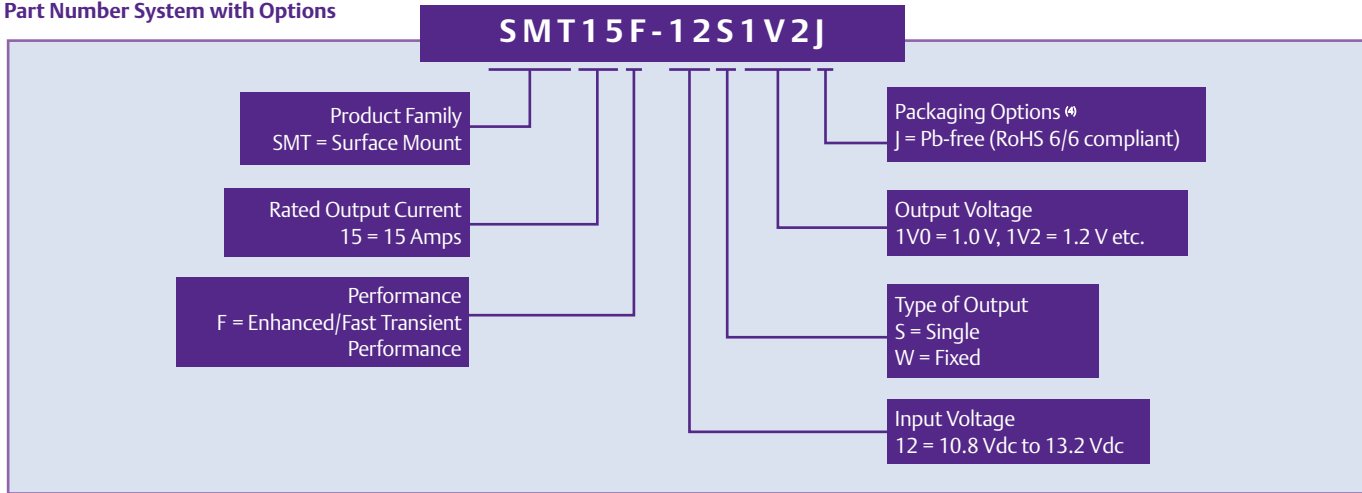

## Notes

- 1 The SMT15F-12 features an 'Active High' Remote ON/OFF operation. If not using the Remote ON/OFF pin, leave the pin open (the converter will be on). The Remote ON/OFF pin is referenced to ground.

The following conditions apply for the SMT15F-12:

Configuration	Converter Operation
Remote pin open circuit	Unit is ON
Remote pin pulled low	Unit is OFF
Remote pin pulled high	Unit is ON

An 'Active Low' Remote ON/OFF version is also possible with this converter. To order please place the Suffix 'R' towards the end of the part number, e.g. SMT15F-12S1V8RJ.

- 2 A 270  $\mu$ F electrolytic input capacitor maybe required for test purposes only.
- 3 An external output capacitor is not required for basic operation. Adding distributed capacitance at the load will improve the transient response.
- 4 TSE RoHS 5/6 (non Pb-free) compliant versions may be available on special request, please contact your local sales representative for details.
- 5 NOTICE: Some models do not support all options. Please contact your local Artesyn representative or use the on-line model number search tool at <http://www.artesyn.com/powergroup/products.htm> to find a suitable alternative.

# Specifications

All specifications are typical at nominal input, full load at 25°C unless otherwise stated.

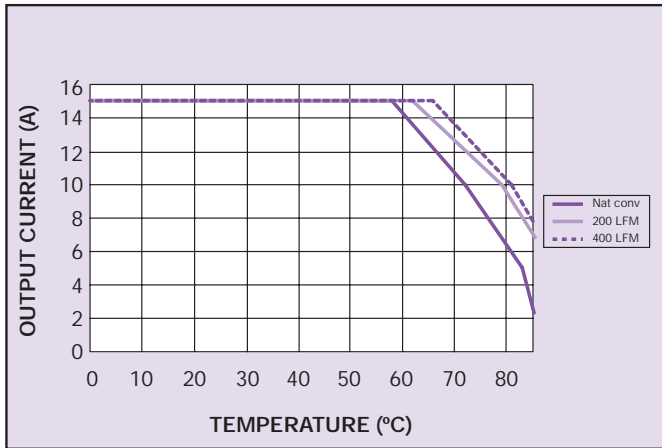

Figure 1 - Derating Curve  
Vin = 12 V, Output Voltage = 1.2 V (See Note A)

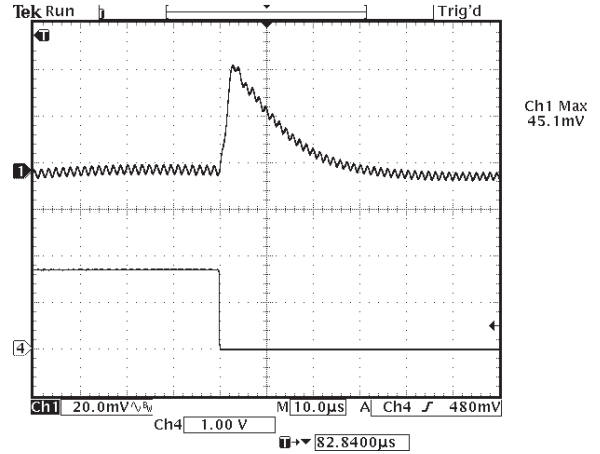

Figure 2 - Typical Transient Response,  
(Vin = 12 V, Output Current = 1.2 V),  
7.5 A Load Step Change; Slew Rate = 200 A/µs  
Channel 1: Voltage Deviation = 45 mV; Recovery Time = 10 µs

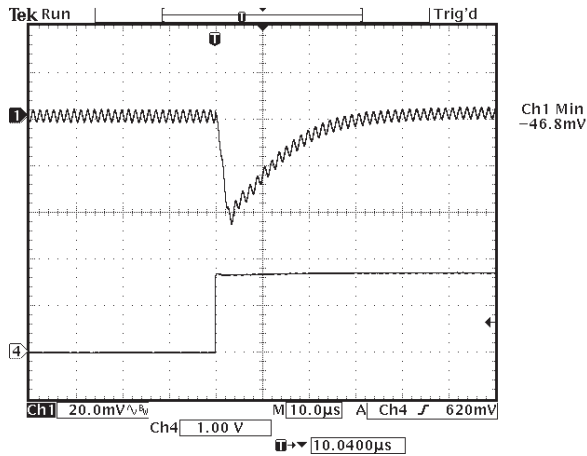

Figure 3 - Typical Transient Response,  
(Vin = 12 V, Output Current = 1.2 V),  
7.5 A Load Step Change; Slew Rate = 200 A/µs  
Channel 1: Voltage Deviation = 46.8 mV; Recovery Time = 10 µs

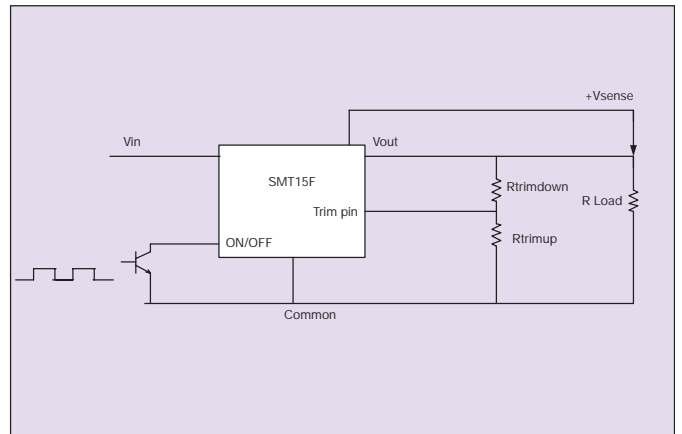

Figure 4 - Standard Application

## Notes

- A The derating curve represents the conditions at which internal components are within the Artesyn derating guidelines.

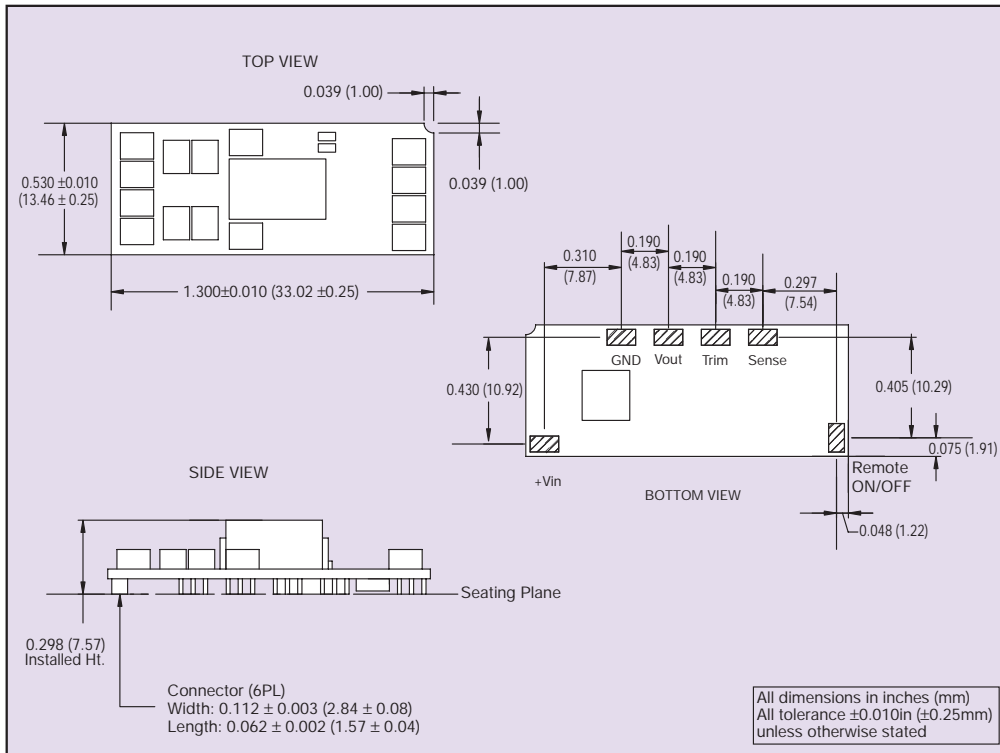

Figure 5 - Mechanical Drawing

PIN CONNECTIONS	
PIN NUMBER	FUNCTION
1	+Vin
2	GND
3	+Vout
4	Trim
5	+Vsense
6	Remote ON/OFF

Figure 5 - Mechanical Drawing and Pinout Table

### Americas

5810 Van Allen Way  
 Carlsbad, CA 92008  
 USA  
 Telephone: +1 760 930 4600  
 Facsimile: +1 760 930 0698

### Europe (UK)

Waterfront Business Park  
 Merry Hill, Dudley  
 West Midlands, DY5 1LX  
 United Kingdom  
 Telephone: +44 (0) 1384 842 211  
 Facsimile: +44 (0) 1384 843 355

### Asia (HK)

16th - 17th Floors, Lu Plaza  
 2 Wing Yip Street, Kwun Tong  
 Kowloon, Hong Kong  
 Telephone: +852 2176 3333  
 Facsimile: +852 2176 3888

For global contact, visit:

[www.powerconversion.com](http://www.powerconversion.com)

[technicalsupport@powerconversion.com](mailto:technicalsupport@powerconversion.com)

While every precaution has been taken to ensure accuracy and completeness in this literature, Emerson Network Power assumes no responsibility, and disclaims all liability for damages resulting from use of this information or for any errors or omissions.

### Emerson Network Power.

The global leader in enabling business-critical continuity.

- AC Power
- Connectivity
- DC Power
- **Embedded Power**
- Inbound Power
- Integrated Cabinet Solutions
- Outside Plant
- Precision Cooling
- Site Monitoring and Services

[EmersonNetworkPower.com](http://EmersonNetworkPower.com)

Emerson Network Power and the Emerson Network Power logo are trademarks and service marks of Emerson Electric Co.  
 ©2007 Emerson Electric Co.