

Technical Specification

SQ100-48-2.5, SQ100-48-2.5N
SQO100-48-2.5, SQO100-48-2.5N

48Vin 2.5Vout 25A

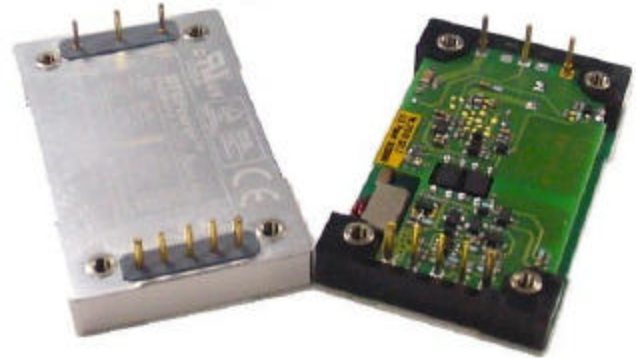

Description

The SQ(Enclosure)/SQO(Open Frame) family of high power density, high efficiency DC/DC converters deliver up to 25A in an industry standard quarter brick footprint. They are targeted specifically at the telecommunication, industrial electronics, mobile telecommunication and distributed power markets. With a wide input voltage range of 36-75V they are available with output voltages of either 1.5, 1.8, 2.5, 3.3 or 5 Volts. All models feature an input filter, input undervoltage lockout, output overvoltage and overtemperature protection, output current limiting and short circuit protection. These converters are available either in a package that is fully enclosed with a six-sided metal shield or an alternative, open-frame construction. In both cases the aluminum heat spreader design achieves very efficient heat transfer with no hot spots. The use of patented Flat Transformer technology and other patented design concepts facilitate very low temperature rise. The use of highly derated power devices help to achieve high reliability, high performance and offer a low cost solution to systems designers requiring maximum power in small footprints.

Applications

- Telecommunications
- Data Communications
- Wireless Communications
- Networking Gear
- Servers, Switches and Data Storage
- Semiconductor Test Equipment
- Distributed Power Architecture

Features

- Delivers up to 25A in a quarter brick
- High power density up to 90W/inch³
- High efficiency Synchronous topology
- Unique Flat Transformer Technology
- No airflow or heat sink required
- No minimum load required
- Low profile of only 0.34 inch
- 1.5V, 1.8V, 2.5V, 3.3V or 5V output models
- Wide input operating range 36-75V
- -40°C to +100°C ambient operation
- Input undervoltage lockout
- Output overvoltage protection
- Output current limit and short circuit protection
- Remote On/Off pin (Negative logic also available)
- Output adjustment +/-10% range
- Output remote sense feature
- 1500V, 10M input-to-output isolation
- Enclosed construction with heat spreader for low temperature rise
- Also available in an open-frame construction
- UL 60950 recognized, TUV EN60950 and CSA C22.2 No. 60950-00 Certified and CE marked
- Meets conducted limits of FCC Class B and CEI IEC61204-3 Class B with external filter
- MTBF of 750,000 hours @ 50°C (MIL-HDBK-217F)

Technical Specification

SQ100-48-2.5, SQ100-48-2.5N
 SQO100-48-2.5, SQO100-48-2.5N

48Vin 2.5Vout 25A

CONVERTER SELECTION

Typical @ $T_a=+25^{\circ}\text{C}$ under nominal line voltage and full load conditions.

Model	Input				Output		Efficiency 75% Load
	Voltage (Volts)		Current (A)		Voltage	Current	
	Nominal	Range	No load	Full load	(Volts)	(Amps)	(%)
SQ100-48-2.5	48	36-75	0.040	1.5	2.5	25	89
SQ100-48-2.5	48	36-75	0.040	1.5	2.5	25	89

For negative logic feature add designator N as suffix to model number, i.e., SQ100-48-2.5N or SQO100-48-2.5N

Consult factory for other output voltage configurations.

Outline Information and Summary Specifications

Pin Connection	
Pin#	Function
1	Vin +
2	On/Off
3	Vin -
4	Vout -
5	Sense -
6	Trim
7	Sense +
8	Vout +

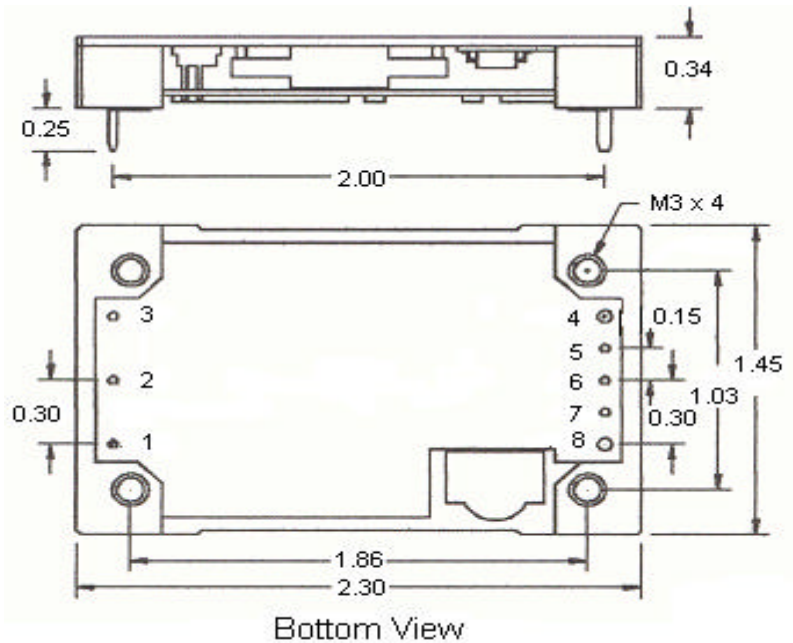

All dimensions are in inches [mm]

Pin 4 and 8 are dia. 0.062 [1.57]

All other pins are all dia. 0.040 [1.02]

Pin material: Brass

Pin finish: Tin/Lead plated

Heat spreader (baseplate) material: Aluminum

Weight: 50.7g (1.8oz)

Tolerance			
Inches		Millimeters	
•XX	± 0.020	•X	± 0.5
•XXX	± 0.010	•XX	± 0.25
Pin:	± 0.002		± 0.05

Thermal derating for vertical orientation, $V_{in}=54V$

Output Voltage (Volts)	Output Current at 40°C (Amps)				Output Current at 60°C (Amps)			
	200 LFM		300 LFM		200 LFM		300 LFM	
	NoHeatsink	With Heatsink	No Heatsink	With Heatsink	No Heatsink	With Heatsink	No Heatsink	With Heatsink
2.5	22	25	24	25	17	25	20	25

The information and specifications contained in this specification are believed to be accurate and reliable at the time of publication. Specifications are subject to change without notice.

Technical Specification

SQ100-48-2.5, SQ100-48-2.5N
SQO100-48-2.5, SQO100-48-2.5N

48Vin 2.5Vout 25A

BTCPower™

Data Sheet

Electrical Specification

Typical test data at Ta=25°C, Vin=48V unless otherwise noted.

PARAMETER	NOTES	MIN	TYP	MAX	UNIT
Absolute maximum rating					
Input voltage		0		80	V
Operating case temperature		-40		100	°C
Storage temperature		-55		125	°C
Humidity				95	%
Input characteristics					
Operating input voltage range		36	48	75	V
Turn on voltage threshold		34	35	36	V
Turn off voltage threshold		33	34	35	V
Transient withstand	Transient duration: 100ms			100	V
Maximum input current	100% load, 36Vin		1.8	2.2	A
Off converter input current	36Vin		2.0	3.5	mA
Output characteristics					
Output voltage set point		2.48	2.50	2.52	V
Output voltage line regulation	36~75 Vin		±1	±1.1	%
Output voltage load regulation	10%-100%Load		±1	±1.1	%
Output voltage trim range	Percentage of normal output	-20		+15	%
Output voltage ripple and noise	20Mz bandwidth, 100% Load, 48Vin		100	150	mV(pk-pk)
Output over power protection		110	120	140	%
Over-voltage protection		3.0	3.3	3.8	V
Output current range		0		25	A
Over-temperature protection			110	120	°C
Temperature coefficient				±0.05	%/°C
Capacitive Load		0		20,000	µF
Output dynamic characteristics					
Startup time	5% to 95% of the output voltage		50	80	ms
Transient recovery time	25% load change			800	µs
Transient Peak Deviation	25% load change			10	%Vo
Efficiency (see efficiency curve)					
100% load efficiency	48 Vin		87		%
Isolation characteristics					
Isolation voltage (primary to secondary)	1minute		1500		VDC
Isolation voltage (primary to case)	1minute		1000		VDC
Isolation voltage (secondary to case)	1minute		1000		VDC
Isolation resistance	500VDC, Primary to secondary	10			MΩ
Isolation capacitance	Primary to secondary			1000	pF
Feature Characteristics					
Switching frequency		340	360	380	KHz
ON/OFF control (Positive logic)					
Converter On		2.5		7	V
Converter Off	SQ100-48-2.5	-1.0		1.2	V
ON/OFF control (Negative logic)					
Converter On		-1.0		1.2	V
Converter Off	SQ100-48-2.5N	2.5		7	V
Calculated MTBF	Bellcore @50°C			1,000,000	Hrs
Weight			40		g

Basic operation and functions

The **SQ(SQO) family** uses FTT technology to achieve high output current. The whole unit switches at the fixed frequency for a predictable EMI performance. Rectification of the transformer's output is done by synchronous rectifiers to make the unit work in a higher efficiency power performance.

The **SQ(SQO) Brick** has many standard controls and protection functions.

Input (pin1, pin3)

Input power $V_{in}(+)$ must be connected to Positive input voltage pin1; Input power $V_{in}(-)$ must be connected to Negative input voltage pin3.

Output (pin8, pin4)

Output power $V_{out}(+)$ must be connected to Positive output voltage pin8; Output power $V_{out}(-)$ must be connected to Negative output voltage pin4.

On/Off (pin 2)

Permits the user to maintain unit On/Off, in order to properly sequence different power supplies and reduce power consumption during the standby condition. There are two remote control options available, positive logic and negative logic is referenced to $V_{in}(-)$, and typical connections are shown in Fig 1.

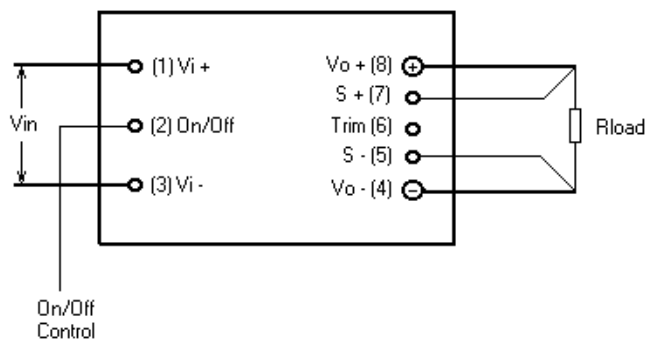

Fig. 1: Typical Circuit for On/Off Function

Pin 2 is the "Enable" pin, connecting a TTL compatible pin. A TTL control signal to this pin, according to the specification, will turn the unit on or off.

The positive logic version turns on when pin 2 is at logic high, and turns off when pin 2 is at logic low. The unit is on when pin 2 is left open.

The negative logic version turns on when pin 2 is at logic low and turns off when pin 2 is at logic high. The pin 2 can be directed to $V_{in}(-)$, to enable automatic turn on to the unit without the need of an external control signal.

Turn on timing vs. Input On/Off Pin is shown in Figure 12, and the Turn off timing vs. Input On/Off pin is shown in Figure 13.

Remote Sense (pin 5, pin 7)

Permits the user to maintain the accurate output voltage at the remote load terminals regardless of the line drop.

The Sense(-) (pin5) and Sense (+) (pin7) should be connected at the load or at the point where the regulation is needed. (shown on Fig. 2)

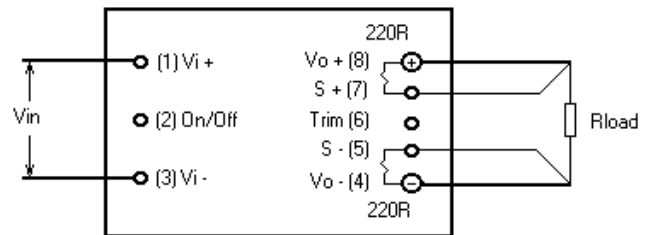

Fig 2: Remote Sense Circuit

The remote sense feature of the unit compensates for voltage drop occurring between the output pins of the unit and load. The Sense(-) (pin5) and Sense(+)(pin7) should be connected at the load or at the point where regulation is required.

Technical Specification

SQ100-48-2.5, SQ100-48-2.5N
SQO100-48-2.5, SQO100-48-2.5N

48Vin 2.5Vout 25A

BTCPower™

Data Sheet

If remote Sense is not required, the Sense(-) pin must be connected to the Vout(-) pin (pin4), and the Sense(+) pin must be connected to the Vout(+) pin(pin 8) to ensure the unit will regulate at the specified output voltage. If these connections are not made, the unit's output voltage will be higher than the specified value.

The unit output over voltage protection senses the voltage across Vout(+) and Vout(-), and not across the sense lines, so the resistance between the output pins of the unit and the load should be minimized to prevent unwanted triggering of the OVP.

When using the remote sense feature, the output voltage at the unit can be increased by as much as 10% above the normal rating, in order to maintain the required voltage across the load. Therefore, the designer must consider this condition.

Also when using the remote sense function, the output power must be taken care of, as not to exceed the maximum power capability of the unit.

Output voltage trim (pin 6)

Permits the user to adjust the output voltage up or down to achieve the custom voltage or to make the output voltage margining. The adjustment range is from + 10% to -20%.

Output voltage can be adjusted up or down, by connecting the Rtrim-up or Rtrim-down resistor as shown. Rtrim-up makes the output voltage go up to 10%; and the Rtrim-down makes the output voltage go down to 20%. (see Fig.5 & Fig. 6)

Leave Trim pin (Pin 6) open for normal output voltage.

When trimming up, care must be taken, not to exceed the unit OVP threshold. A typical circuit is shown in Fig. 3.

Also, care must be taken not to exceed the unit's maximum allowable output power.

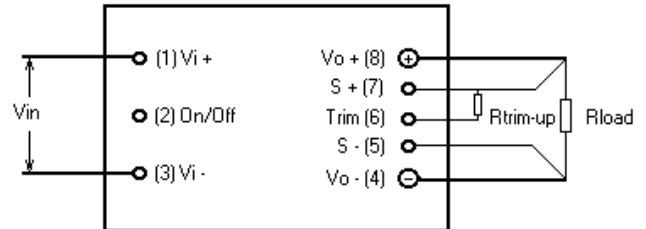

Fig 3. Trim Up Output Voltage Circuit

For Trim up resistor value, we list the reference "Trim Up Resistance" for increasing the output voltage for every 1 percent (see Trim Table 1).

Fig 5. shows "Trim Up Resistance" value chart.

Trimming down the output voltage for a typical circuit, as shown on Fig. 4.

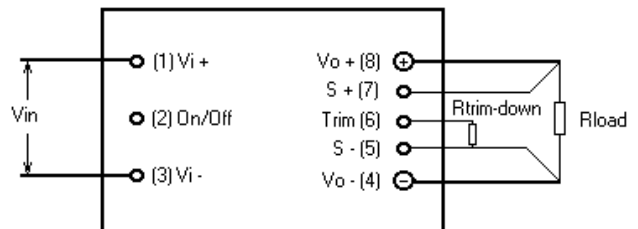
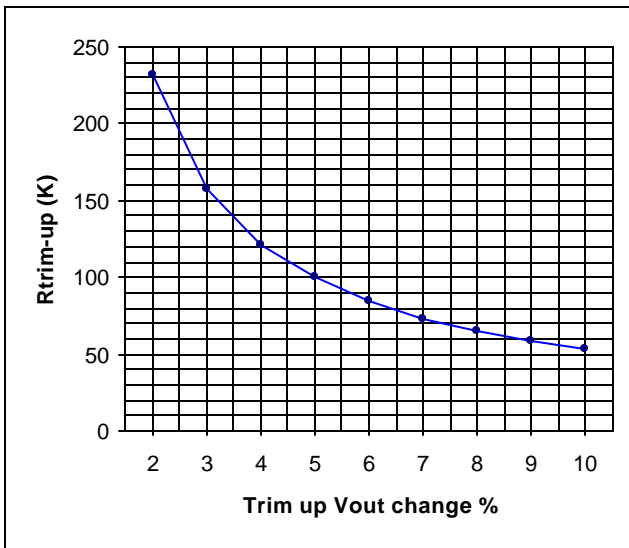

Fig 4. Trim Down Output Voltage Circuit

For Trim down resistance value, we list the reference "Trim Down Resistance" for decreasing output voltage for every 1 percent (see Trim Table 2.).

Fig 6 shows "Trim Down Resistance" value chart.



Rtrim-up(K)	Vout(v)	Trim up Vout %
232	2.55	2
158	2.575	3
121	2.6	4
100	2.625	5
84.5	2.65	6
73.2	2.675	7
64.9	2.7	8
59	2.725	9
53.6	2.75	10

Table 1: Rtrim-up resistor values.

Fig 5. Trim Up Resistance for reference chart

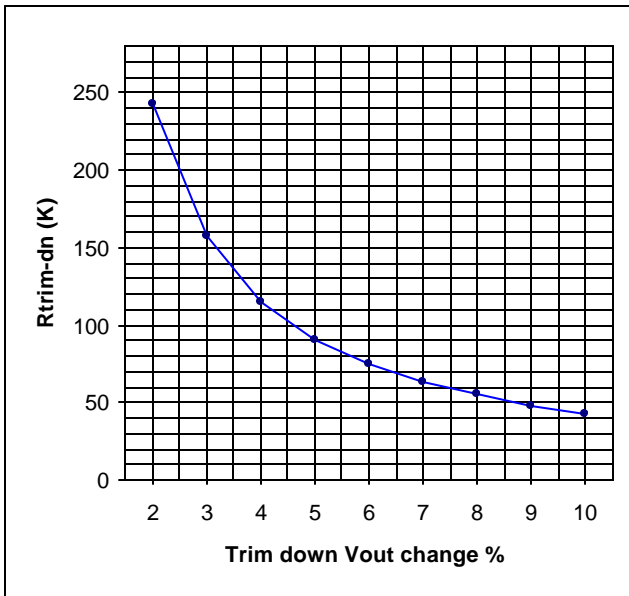

Rtrim-dn(K)	Vout(v)	Trim down Vout %
243	2.45	2
158	2.425	3
115	2.4	4
90.9	2.375	5
75	2.35	6
63.4	2.325	7
54.9	2.3	8
47.5	2.275	9
42.2	2.25	10

Table 2: Rtrim-down resistor values.

Fig 6 Trim Down Resistance for reference chart

Protection Features

Input Under-voltage Lockout (IUV)

Input under voltage lockout (IUV) is standard with the SQ(SQO) unit. The unit will shut down when the input voltage drops below a threshold, and the unit will turn on when the input voltage goes to the upper threshold.

The hysteric voltage of the under voltage protection is 2 V, normally from the 33.5V to 35.5V range.

Output Over-current Protection (OCP)

The unit will shut down when the over current or short circuit condition exists.

Once the OCP happens, the unit has shut down. The attempted restart will continue indefinitely until the over current or short circuit condition is removed. When OCP happens, the output voltage drops below 1.1V.

Figure 19 shows output voltage vs. output current limit point and the unit's shutdown point.

Input voltage has almost no effect on the current limit point.

Output Over-voltage Protection (OVP)

The unit will shut down when the output voltage exceeds the over voltage threshold. If the output voltage across Vout(+) (pin8) and Vout(-) (pin4) exceeds the threshold of the OVP circuitry, the unit has shut down which is caused by an OVP circuit, and the unit will never restart, and the output voltage is below 0.5V.

Over Temperature Protection (OTP)

The unit will shut down when the base plate temperature exceeds the protection threshold.

The unit will shut down under the base plate temperature over a 110°C condition to protect the unit from overheating. The OTP circuit will turn the unit off when OTP happens. Once the unit has shut down, it will restart at the cycle when the base plate temperature goes down.

Application and consideration

Input Source Impedance

The unit has been designed to be stable with no external capacitors when used in a low inductance input and output circuit.

However in many applications, the inductance with the distribution from the power source to the input of the unit can affect the stability of the unit. The addition of 47uF electrolytic capacitor with an $Esr < 1\Omega$ (at 100kHz) across the input can ensure the stability of the unit. Also in many applications, the user has to use decoupling capacitors at the output load, to ensure the hold up time for the load.

Safety Requirements and Considerations

The unit meets the American and International safety regulatory requirement UL60950, TUV EN 60950, CSA C22.2 No. 60950-00. Basic insulation is also provided between the input side and the output side.

To meet safety agencies requirements, an input line fuse must be used external to the unit. An 8A fuse or less with a normal blow rate must be used to meet the safety agencies requirements

If the input source is non-SELV (ELV or a hazardous voltage greater than 60 Vdc and less than or equal to 75 Vdc), for the unit output to be considered meeting the requirements of safety extra low voltage (SELV), all of the following must be met:

- The input source is to be provided with reinforced insulation from any hazardous voltage, including the ac main.
- The input pins of the unit are not operator accessible.

- For whole system, for safety agencies requirements, and for the combination of the unit's input side (primary side) and the unit's output side (secondary side), verify that under a single fault, hazardous voltages do not appear at the unit's output side (secondary side).
- Never ground either of the input pins of the unit without grounding one of the output pins. This may allow a non-SELV voltage to appear between the output pin and ground.

Electromagnetic Compatibility (EMC)

EMC requirements must be met at the end product and system level from the customer. As there is no specific standards dedicated to the EMC of board-mounted DC/DC converter, which exist. However the SQ(SQO) Family unit has been tested for EMC requirement levels.

With the addition of a simple external filter (see Fig 7.), the SQ(SQO) Family unit passes the FCC class B test conducted and CEI IEC61204-3 Class B.

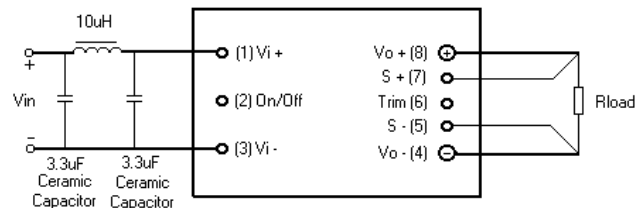

Fig 7. External filter circuit for EMC.

Technical Specification

SQ100-48-2.5, SQ100-48-2.5N
SQO100-48-2.5, SQO100-48-2.5N

48Vin 2.5Vout 25A

BTCPower™

Data Sheet

With this addition of an external simple filter circuit, we can easily meet the EMC agencies requirements. The EMC test result is shown on Fig 8 below.

Input Transient Withstand

SQ(SQO) unit can withstand input transient voltage with 100v/100ms pulse, and never be damaged.

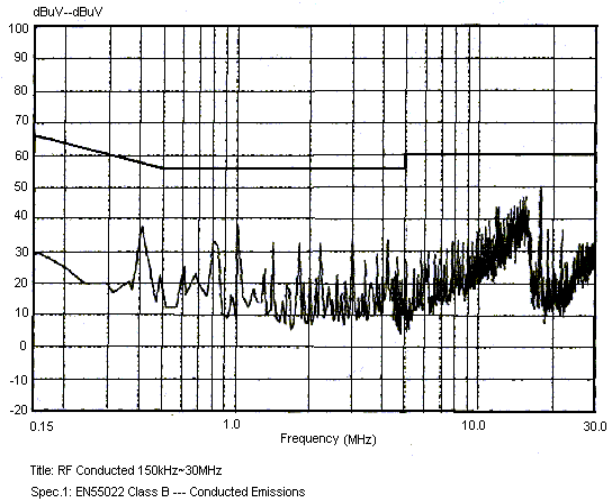

Fig 8. EMC conducted test result

Characterization

General information

The SQ(SQO) unit has many operational characterized aspects, including thermal derating, efficiency, start up and down timing parameter, overshoot, output ripple & noise, dynamic response to load, and over current protection curves.

The following pages contain specific plots or waveforms associated with the unit. Additional comments for specific data are provided below.

Test Conditions

All data presented herein were taken with the unit soldered to a test board, which is a 0.060" thick printed circuit board. All measurements require an airflow wind with airflow meter measuring the airflow LFM value.

For the input line, a 47uF/100V electrolytic capacitor with $Esr < 1 \Omega$ is used in the test. It is better to make the 47uF capacitor closed to the unit. For the output, a 10uF tantalum capacitor with $Esr < 0.12\Omega$ and 1uF ceramic capacitor has been used for the test. Also it is better when these two capacitors are close to the unit.

Note:

It is important to make sure that the components on the unit do not exceed their rating.

Thermal Derating

For thermal derating, output current vs. ambient temperature and airflow rates are tested, and the test graphic is shown in Fig 23.

Ambient temperature was varied between 25°C and 85°C, with airflow rates from 0 LFM to 300LFM (0 to 1.5 m/s).

Figure 23 shows that maximum output power derating vs. ambient air temperature with airflow rates of 0LFM through 300 LFM. At $V_{in}=48v$.

Figure 24 shows output power derating vs. ambient air temperature with airflow rates of 0LFM through 300LFM. At $V_{in}=48v$. (Open frame, without heatsink)

Efficiency

Efficiency vs. load current curve is given below. The ambient temperature is 25°C, airflow is 200LFM(1m/s), and the input voltage is 36V, 48V, and 75V conditions.

Figure 14 shows that Efficiency at nominal output voltage vs. output current for various Input voltage.

Start up

During the turn on transient using the On/Off pin for full rated current and No load conditions, the output voltage waveforms are given in the below.

Fig 9, Fig 10 and Fig 11 show that all different kind of start up waveform.

Ripple and Noise

The output voltage waveform measured at No load and Full load current, with 10uF tantalum and 1uF ceramic capacitor across to close the unit.

Figure 21 and Figure 22 show that output voltage Ripple & Noise at $V_{in}=48v$ and different load condition.

Start up information

Scenario #1: Initial Start up from power supply

On/Off function enabled, the unit starts via input voltage Vin
See Fig 9.

Time	Comments
t0	On/Off pin is On: system front-end power is switched on, Vin to unit begins to rise.
t1	Vin crosses Under voltage lockout protection circuit threshold: the unit enabled to be on
t2	The unit begins to turn on (unit turn-on delay).
t3	Unit output voltage reaches 100% of normal voltage.

For this example, the unit total start up time (t3- t1) is typically 45ms.

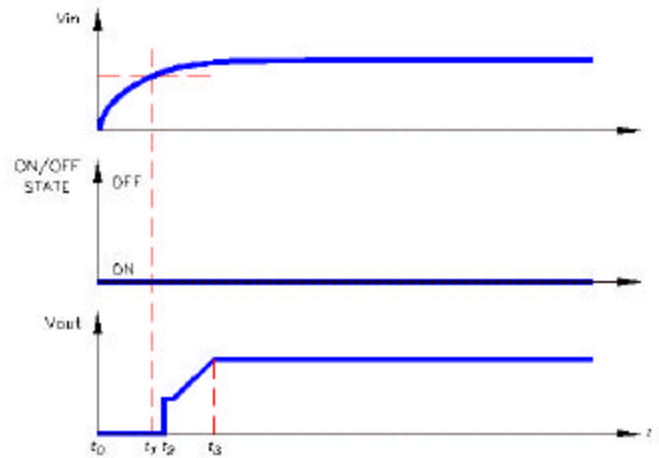

Fig 9. Start up waveform

Scenario #2: Initial Start up using On/Off Pin

With Vin previously powered, the unit starts via On/Off pin.
See Fig 10.

Time	Comments
t0	Vin at nominal value.
t1	Arbitrary time when On/Off pin is enabled (Unit enabled)
t2	End of unit turn-on delay
t3	Unit Vout reaches 100% of nominal voltage.

For this example, the unit total start up time (t3- t1) is typically 70ms.

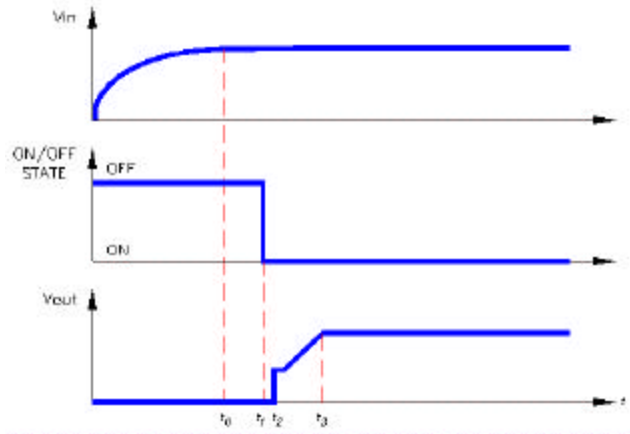

Fig 10. Start up using On/Off pin

Scenario #3: Turn-off and restart using On/Off Pin

With Vin previously powered, the unit is disabled and then enabled via On/Off pin. See Fig 11.

Time	Comments
t0	Vin and Vout are at nominal values, On/Off pin On.
t1	On/Off pin arbitrarily disabled, the unit output falls to zero. Turn-on inhibit delay period (100ms) is initiated, and On/Off pin action is internally inhibited.
t2	On/Off pin is externally re-enabled. If (t2- t1) ≤ 100ms, external action of On/Off pin is locked out by start up inhibit timer. If (t2- t1) > 100ms, On/Off pin is On, the unit begins turn-on; if off, the unit awaits On/Off pin On signal; see Fig 11.
t3	Unit Vout reaches 100% of nominal voltage.

For the condition, (t2- t1) ≤ 100ms, the unit total start up time (t5- t2) is typically 200ms. For (t2- t1) > 100ms, start up should be typically 45ms after release of On/Off pin.

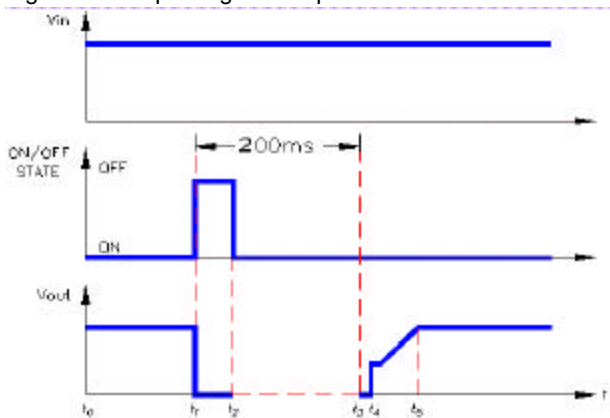

Fig 11. Turn off and restart using On/Off pin

On/Off Control Power Up/Down

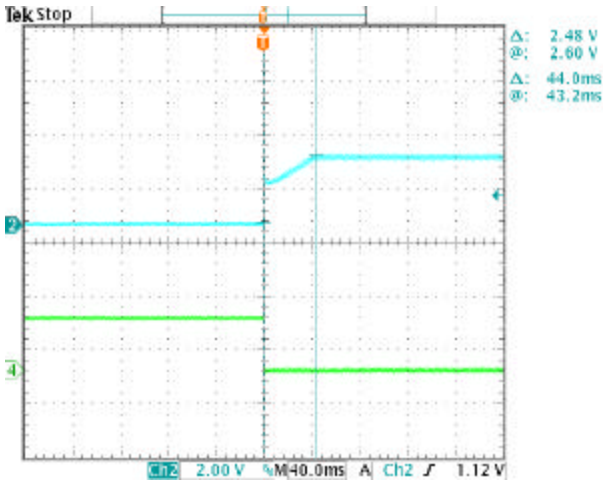

Figure 12. Turn on timing vs. Input On/Off Pin. Waveform 2 is output voltage, waveform 4 is negative On/Off logic signal. At 48v input voltage, 20A output current with 100uf output capacitance load.

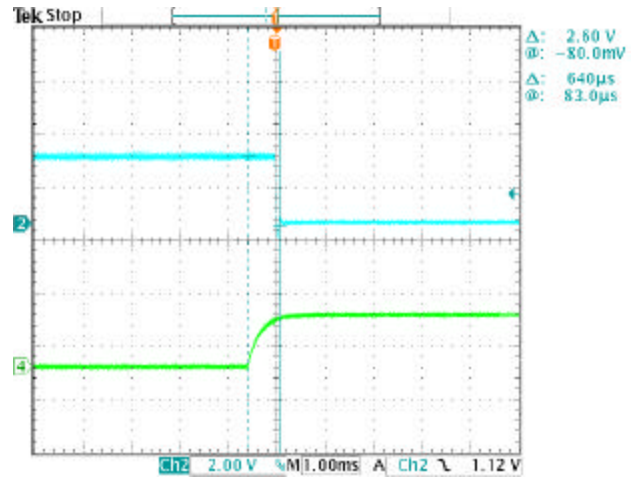

Figure 13. Turn off timing vs. Input On/Off Pin. Waveform 2 is output voltage, waveform 4 is negative On/Off logic signal. At 48v input voltage, 20A output current with 100uf output capacitance load.

Efficiency

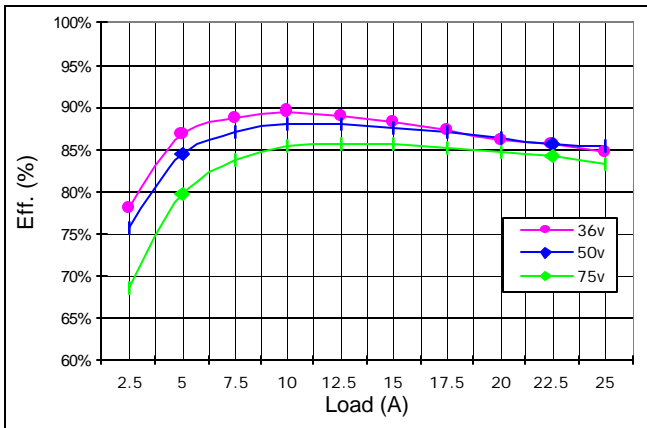

Figure 14. Efficiency at nominal output voltage vs. output current for various Input voltage. The unit mounted on the 0.06" thick PCB with 300LFM air flow (1.5/m) from pin 3 to pin 4 and Ta=25°C

Technical Specification

SQ100-48-2.5, SQ100-48-2.5N
SQO100-48-2.5, SQO100-48-2.5N

BTCPower™

Data Sheet

48Vin 2.5Vout 25A

Dynamic Response

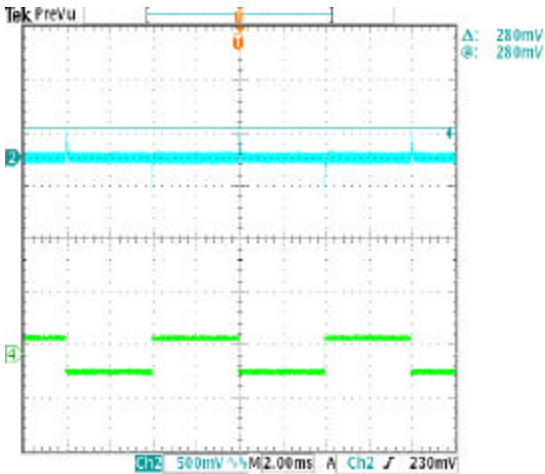

Figure 15. Output voltage dynamic response at Vin=48v Iout= 12~20A, 2.5A/us dynamic load. waveform 2 is dynamic response via dynamic load. waveform 4 is load current (2.5A/us); with 10uF output capacitance load.

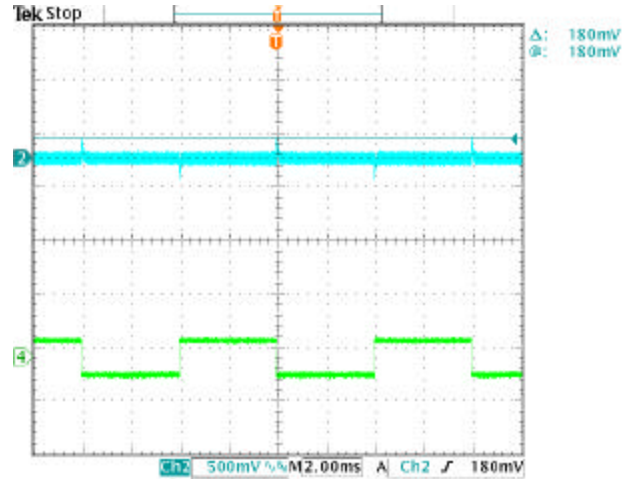

Figure 16. Output voltage dynamic response at Vin=48v Iout= 12~20A, 2.5A/us dynamic load. waveform 2 is dynamic response via dynamic load. waveform 4 is load current (2.5A/us); with 220uF output capacitance load.

Overshoot

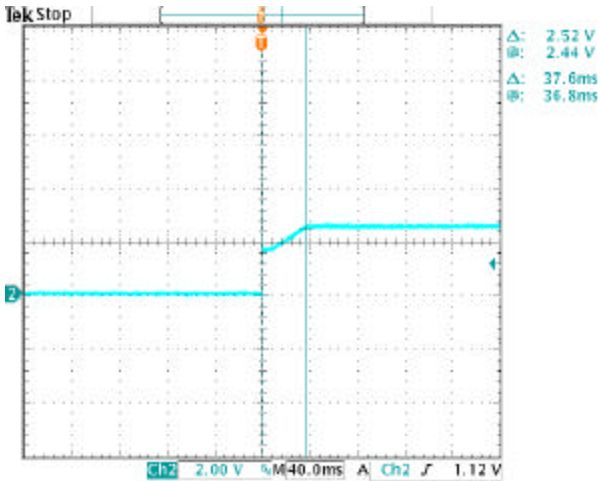

Figure 17. Output voltage over shoot and rise time at Vin=48v, Iout = 0A; with 100uF output capacitance load, and On/Off pin enabled to turn on the unit.

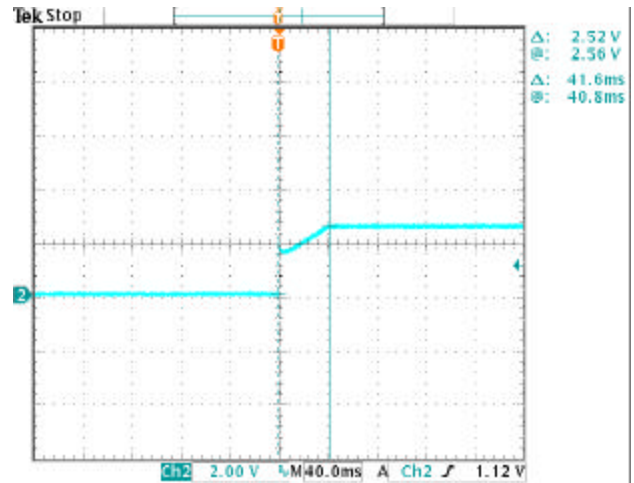

Figure 18. Output voltage over shoot and rise time at Vin=48v, Iout=20A; with 100uF output capacitance load, and On/Off enabled to turn on the unit.

Technical Specification

SQ100-48-2.5, SQ100-48-2.5N
SQO100-48-2.5, SQO100-48-2.5N

BTCPower™

Data Sheet

48Vin 2.5Vout 25A

Over Current and Short Circuit

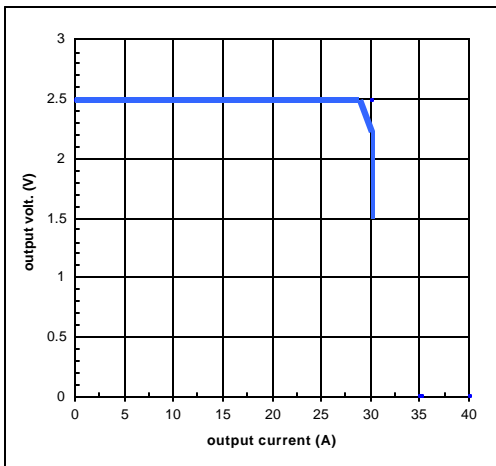

Figure 19. Output voltage vs. output current limit point and the unit shutdown point. Input voltage has almost no effect on current limit point.

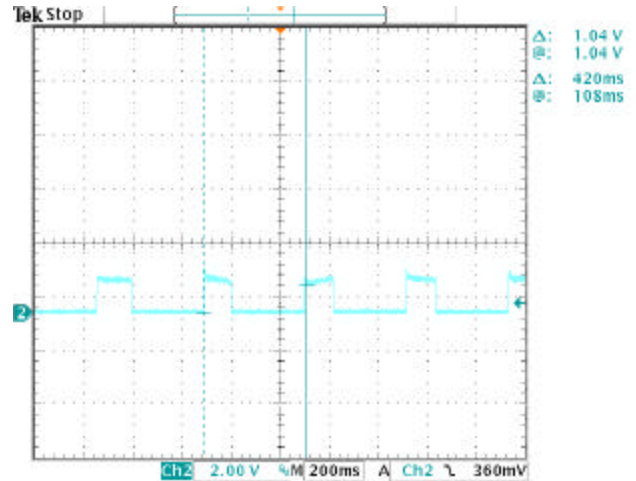

Figure 20. Output waveform under short circuit protection condition. Under 10mΩ short circuit during restart at 48Vin.

Ripple and Noise

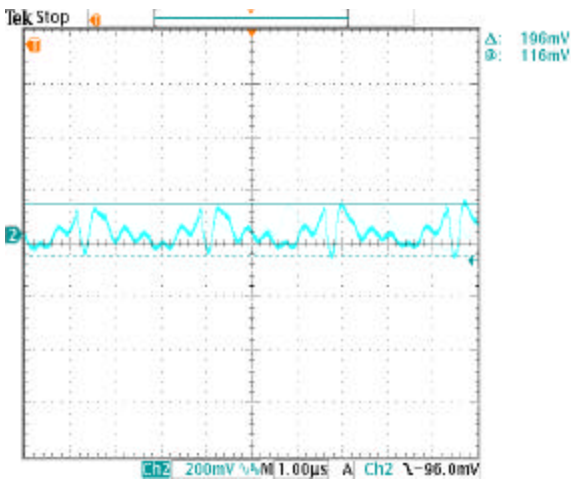

Figure 21. Output voltage Ripple & Noise at Vin=48v, Iout=0A, with 10uF tantalum cap. and 1uf ceramic cap. output capacitance load.

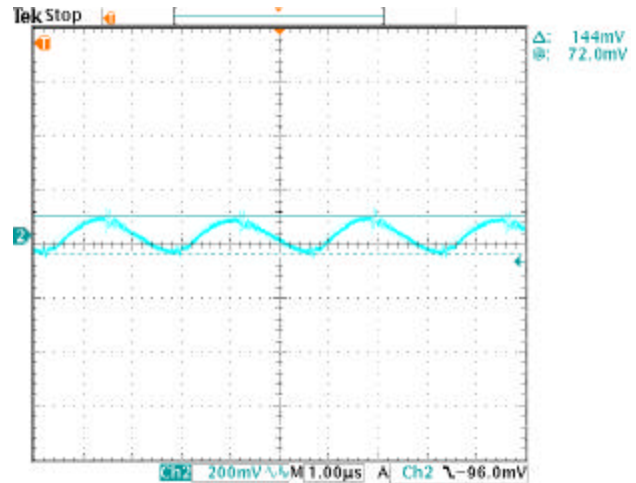

Figure 22. Output voltage Ripple & Noise, at Vin=48v, Iout=20A, with 10uF tantalum cap. and 1uf ceramic cap. output capacitance load.

Temperature derating

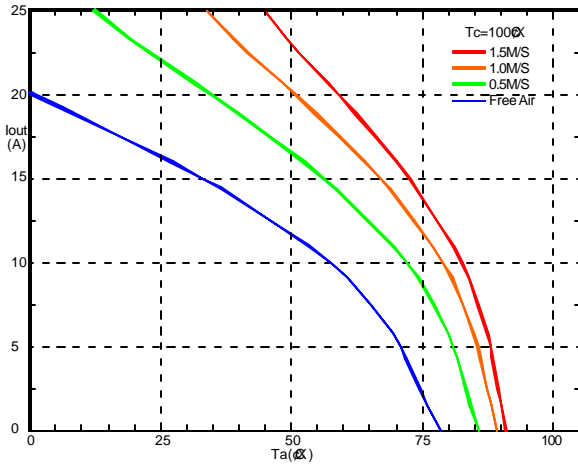

Figure 23. Maximum output power derating vs. ambient air temperature with airflow rates of 0LFM through 300 LFM. At Vin=48v. (without heatsink)

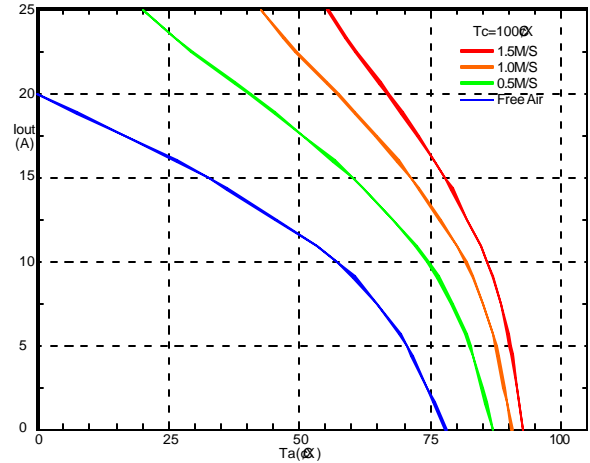

Figure 24. Maximum output power derating vs. ambient air temperature with airflow rates of 0LFM through 300 LFM. At Vin=48v. (Open Frame, without heatsink)

Technical Specification

SQ100-48-2.5, SQ100-48-2.5N
SQO100-48-2.5, SQO100-48-2.5N

48Vin 2.5Vout 25A

BTCPower™

Data Sheet

Input reflected ripple current

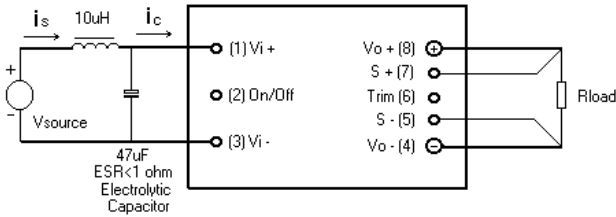

Figure 25. Test set up for measuring Input reflected ripple currents, \dot{I}_c and \dot{I}_s .

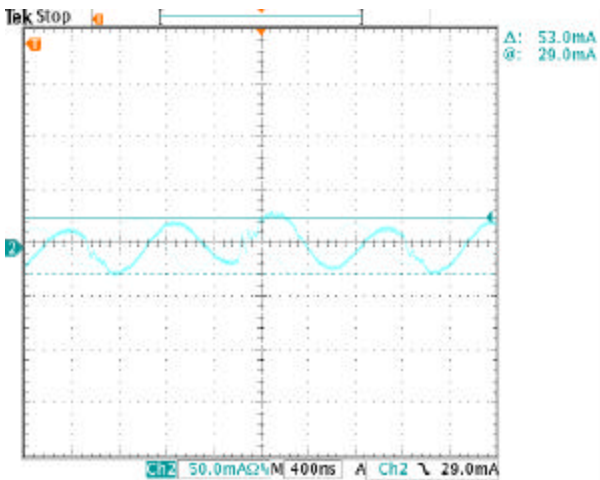

Figure 26. Input reflected ripple current \dot{I}_c waveform without input inductor. At $V_{in}=48v$, $I_{out}=25A$, 50ma/Div. (current probe with 50mv/div)

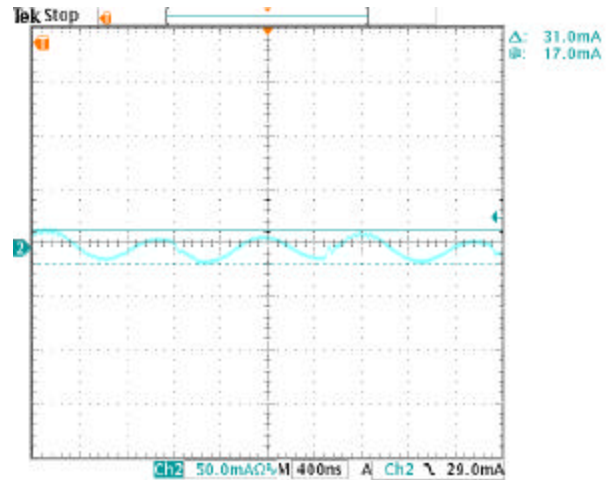

Figure 27. Input reflected ripple current \dot{I}_s waveform With 10uH input inductor. At $V_{in}=48v$, $I_{out}=25A$, 50ma/Div (current probe with 50mv/div)

For More Information, Please Contact

sales@btcpower.com

support@btcpower.com

www.btcpower.com