



CY7C1470BV25 CY7C1472BV25, CY7C1474BV25

72-Mbit (2M x 36/4M x 18/1M x 72) Pipelined SRAM with NoBL™ Architecture

Features

- Pin-compatible and functionally equivalent to ZBT™
- Supports 250 MHz bus operations with zero wait states
 - Available speed grades are 250, 200, and 167 MHz
- Internally self-timed output buffer control to eliminate the need to use asynchronous OE
- Fully registered (inputs and outputs) for pipelined operation
- Byte Write capability
- Single 2.5V power supply
- 2.5V IO supply (V_{DDQ})
- Fast clock-to-output times
 - 3.0 ns (for 250-MHz device)
- Clock Enable (\overline{CEN}) pin to suspend operation
- Synchronous self-timed writes
- CY7C1470BV25, CY7C1472BV25 available in JEDEC-standard Pb-free 100-pin TQFP, Pb-free and non-Pb-free 165-ball FBGA package. CY7C1474BV25 available in Pb-free and non-Pb-free 209-ball FBGA package
- IEEE 1149.1 JTAG Boundary Scan compatible
- Burst capability—linear or interleaved burst order
- “ZZ” Sleep Mode option and Stop Clock option

Functional Description

The CY7C1470BV25, CY7C1472BV25, and CY7C1474BV25 are 2.5V, 2M x 36/4M x 18/1M x 72 synchronous pipelined burst SRAMs with No Bus Latency™ (NoBL™) logic, respectively. They are designed to support unlimited true back-to-back read or write operations with no wait states. The CY7C1470BV25, CY7C1472BV25, and CY7C1474BV25 are equipped with the advanced (NoBL) logic required to enable consecutive read or write operations with data being transferred on every clock cycle. This feature dramatically improves the throughput of data in systems that require frequent read or write transitions. The CY7C1470BV25, CY7C1472BV25, and CY7C1474BV25 are pin-compatible and functionally equivalent to ZBT devices.

All synchronous inputs pass through input registers controlled by the rising edge of the clock. All data outputs pass through output registers controlled by the rising edge of the clock. The clock input is qualified by the Clock Enable (\overline{CEN}) signal, which when deasserted suspends operation and extends the previous clock cycle. Write operations are controlled by the Byte Write Selects (\overline{BW}_a – \overline{BW}_d for CY7C1470BV25, \overline{BW}_a – \overline{BW}_b for CY7C1472BV25, and \overline{BW}_a – \overline{BW}_h for CY7C1474BV25) and a Write Enable (\overline{WE}) input. All writes are conducted with on-chip synchronous self-timed write circuitry.

Three synchronous Chip Enables (\overline{CE}_1 , \overline{CE}_2 , \overline{CE}_3) and an asynchronous Output Enable (\overline{OE}) provide for easy bank selection and output tri-state control. To avoid bus contention, the output drivers are synchronously tri-stated during the data portion of a write sequence.

Selection Guide

| Description | 250 MHz | 200 MHz | 167 MHz | Unit |
|------------------------------|---------|---------|---------|------|
| Maximum Access Time | 3.0 | 3.0 | 3.4 | ns |
| Maximum Operating Current | 450 | 450 | 400 | mA |
| Maximum CMOS Standby Current | 120 | 120 | 120 | mA |

Logic Block Diagram – CY7C1470BV25 (2M x 36)

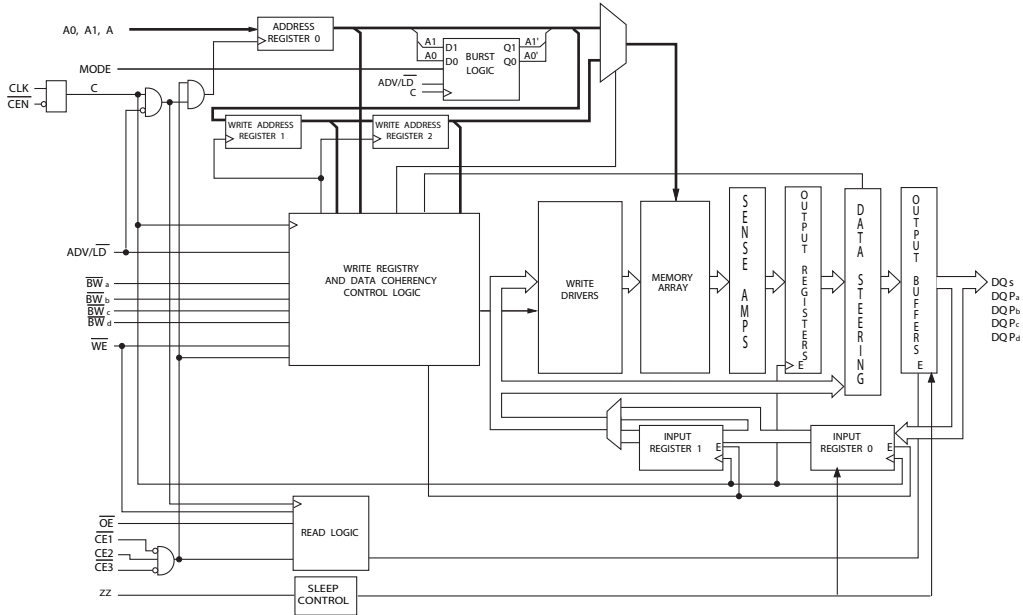

Logic Block Diagram – CY7C1472BV25 (4M x 18)

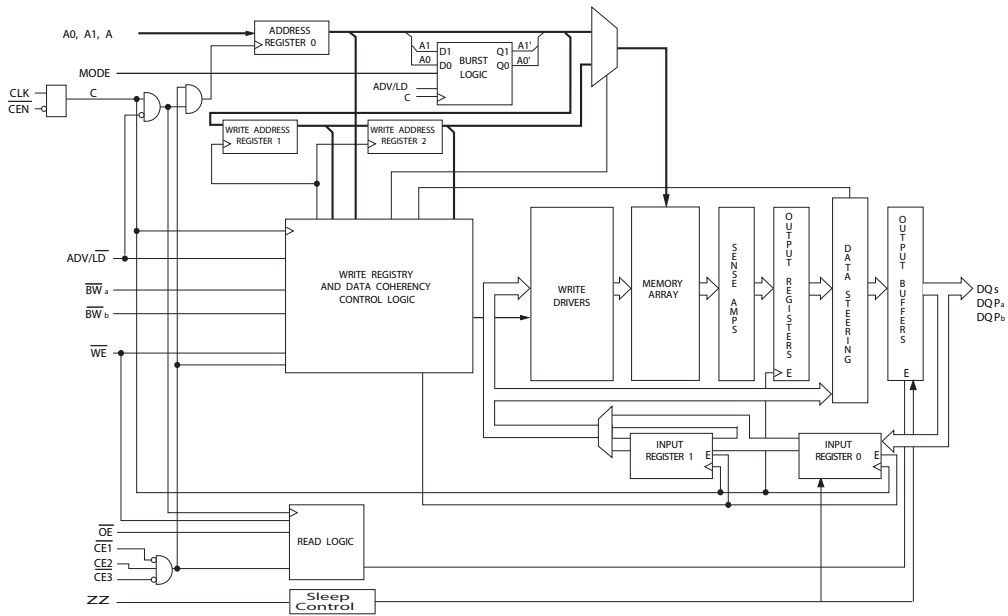

Logic Block Diagram – CY7C1474BV25 (1M x 72)

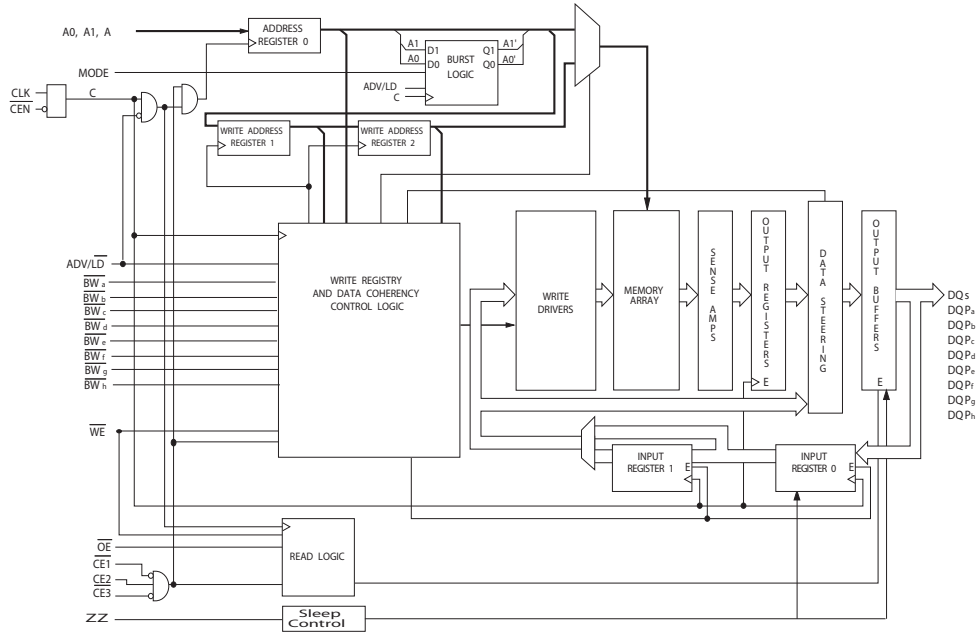

Pin Configurations

Figure 1. 100-Pin TQFP Pinout

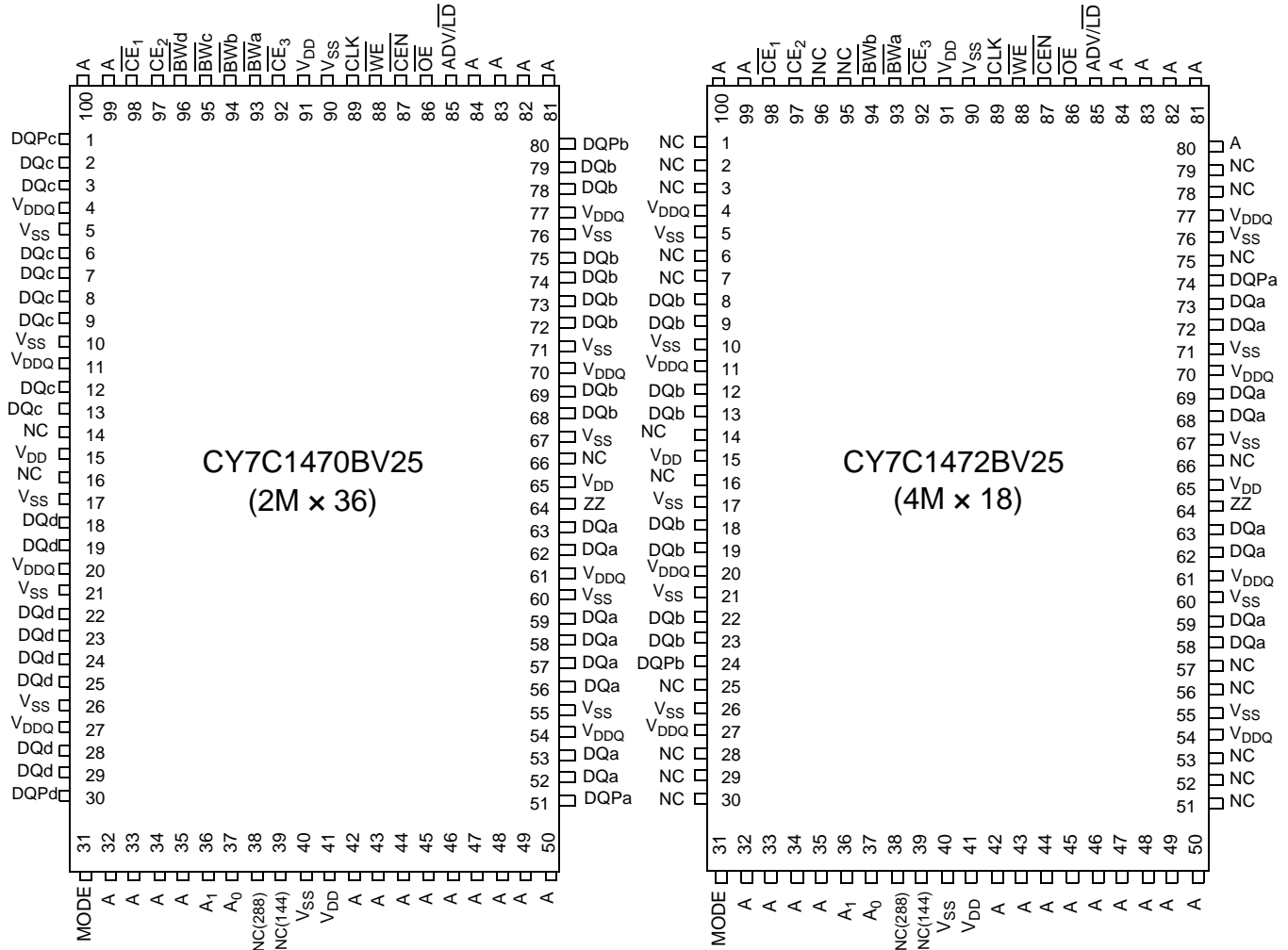

Pin Configurations (continued)

165-Ball FBGA (15 x 17 x 1.4 mm) Pinout
CY7C1470BV25 (2M x 36)

| | 1 | 2 | 3 | 4 | 5 | 6 | 7 | 8 | 9 | 10 | 11 |
|----------|------------------|-----------------|-------------------|-------------------|-------------------|-------------------|------------------|-----------------|------------------|-----------------|------------------|
| A | NC/576M | A | \overline{CE}_1 | \overline{BW}_c | \overline{BW}_b | \overline{CE}_3 | \overline{CEN} | ADV/LD | A | A | NC |
| B | NC/1G | A | CE2 | \overline{BW}_d | \overline{BW}_a | CLK | \overline{WE} | \overline{OE} | A | A | NC |
| C | DQP _c | NC | V _{DDQ} | V _{SS} | V _{SS} | V _{SS} | V _{SS} | V _{SS} | V _{DDQ} | NC | DQP _b |
| D | DQ _c | DQ _c | V _{DDQ} | V _{DD} | V _{SS} | V _{SS} | V _{SS} | V _{DD} | V _{DDQ} | DQ _b | DQ _b |
| E | DQ _c | DQ _c | V _{DDQ} | V _{DD} | V _{SS} | V _{SS} | V _{SS} | V _{DD} | V _{DDQ} | DQ _b | DQ _b |
| F | DQ _c | DQ _c | V _{DDQ} | V _{DD} | V _{SS} | V _{SS} | V _{SS} | V _{DD} | V _{DDQ} | DQ _b | DQ _b |
| G | DQ _c | DQ _c | V _{DDQ} | V _{DD} | V _{SS} | V _{SS} | V _{SS} | V _{DD} | V _{DDQ} | DQ _b | DQ _b |
| H | NC | NC | NC | V _{DD} | V _{SS} | V _{SS} | V _{SS} | V _{DD} | NC | NC | ZZ |
| J | DQ _d | DQ _d | V _{DDQ} | V _{DD} | V _{SS} | V _{SS} | V _{SS} | V _{DD} | V _{DDQ} | DQ _a | DQ _a |
| K | DQ _d | DQ _d | V _{DDQ} | V _{DD} | V _{SS} | V _{SS} | V _{SS} | V _{DD} | V _{DDQ} | DQ _a | DQ _a |
| L | DQ _d | DQ _d | V _{DDQ} | V _{DD} | V _{SS} | V _{SS} | V _{SS} | V _{DD} | V _{DDQ} | DQ _a | DQ _a |
| M | DQ _d | DQ _d | V _{DDQ} | V _{DD} | V _{SS} | V _{SS} | V _{SS} | V _{DD} | V _{DDQ} | DQ _a | DQ _a |
| N | DQP _d | NC | V _{DDQ} | V _{SS} | NC | NC | NC | V _{SS} | V _{DDQ} | NC | DQP _a |
| P | NC/144M | A | A | A | TDI | A1 | TDO | A | A | A | NC/288M |
| R | MODE | A | A | A | TMS | A0 | TCK | A | A | A | A |

CY7C1472BV25 (4M x 18)

| | 1 | 2 | 3 | 4 | 5 | 6 | 7 | 8 | 9 | 10 | 11 |
|----------|------------------|-----------------|-------------------|-------------------|-------------------|-------------------|------------------|-----------------|------------------|-----------------|------------------|
| A | NC/576M | A | \overline{CE}_1 | \overline{BW}_b | NC | \overline{CE}_3 | \overline{CEN} | ADV/LD | A | A | A |
| B | NC/1G | A | CE2 | NC | \overline{BW}_a | CLK | \overline{WE} | \overline{OE} | A | A | NC |
| C | NC | NC | V _{DDQ} | V _{SS} | V _{SS} | V _{SS} | V _{SS} | V _{SS} | V _{DDQ} | NC | DQP _a |
| D | NC | DQ _b | V _{DDQ} | V _{DD} | V _{SS} | V _{SS} | V _{SS} | V _{DD} | V _{DDQ} | NC | DQ _a |
| E | NC | DQ _b | V _{DDQ} | V _{DD} | V _{SS} | V _{SS} | V _{SS} | V _{DD} | V _{DDQ} | NC | DQ _a |
| F | NC | DQ _b | V _{DDQ} | V _{DD} | V _{SS} | V _{SS} | V _{SS} | V _{DD} | V _{DDQ} | NC | DQ _a |
| G | NC | DQ _b | V _{DDQ} | V _{DD} | V _{SS} | V _{SS} | V _{SS} | V _{DD} | V _{DDQ} | NC | DQ _a |
| H | NC | NC | NC | V _{DD} | V _{SS} | V _{SS} | V _{SS} | V _{DD} | NC | NC | ZZ |
| J | DQ _b | NC | V _{DDQ} | V _{DD} | V _{SS} | V _{SS} | V _{SS} | V _{DD} | V _{DDQ} | DQ _a | NC |
| K | DQ _b | NC | V _{DDQ} | V _{DD} | V _{SS} | V _{SS} | V _{SS} | V _{DD} | V _{DDQ} | DQ _a | NC |
| L | DQ _b | NC | V _{DDQ} | V _{DD} | V _{SS} | V _{SS} | V _{SS} | V _{DD} | V _{DDQ} | DQ _a | NC |
| M | DQ _b | NC | V _{DDQ} | V _{DD} | V _{SS} | V _{SS} | V _{SS} | V _{DD} | V _{DDQ} | DQ _a | NC |
| N | DQP _b | NC | V _{DDQ} | V _{SS} | NC | NC | NC | V _{SS} | V _{DDQ} | NC | NC |
| P | NC/144M | A | A | A | TDI | A1 | TDO | A | A | A | NC/288M |
| R | MODE | A | A | A | TMS | A0 | TCK | A | A | A | A |

Pin Configurations (continued)

209-Ball FBGA (14 x 22 x 1.76 mm) Pinout
CY7C1474BV25 (1M x 72)

| | 1 | 2 | 3 | 4 | 5 | 6 | 7 | 8 | 9 | 10 | 11 |
|----------|------|------|------------------|------------------|-----------------|-----------------|-----------------|------------------|------------------|------|------|
| A | DQg | DQg | A | CE ₂ | A | ADV/LD | A | CE ₃ | A | DQb | DQb |
| B | DQg | DQg | BWS _c | BWS _g | NC | WE | A | BWS _b | BWS _f | DQb | DQb |
| C | DQg | DQg | BWS _h | BWS _d | NC/576M | CE ₁ | NC | BWS _e | BWS _a | DQb | DQb |
| D | DQg | DQg | V _{SS} | NC | NC/1G | OE | NC | NC | V _{SS} | DQb | DQb |
| E | DQPg | DQPc | V _{DDQ} | V _{DDQ} | V _{DD} | V _{DD} | V _{DD} | V _{DDQ} | V _{DDQ} | DQPf | DQPb |
| F | DQc | DQc | V _{SS} | V _{SS} | V _{SS} | NC | V _{SS} | V _{SS} | V _{SS} | DQf | DQf |
| G | DQc | DQc | V _{DDQ} | V _{DDQ} | V _{DD} | NC | V _{DD} | V _{DDQ} | V _{DDQ} | DQf | DQf |
| H | DQc | DQc | V _{SS} | V _{SS} | V _{SS} | NC | V _{SS} | V _{SS} | V _{SS} | DQf | DQf |
| J | DQc | DQc | V _{DDQ} | V _{DDQ} | V _{DD} | NC | V _{DD} | V _{DDQ} | V _{DDQ} | DQf | DQf |
| K | NC | NC | CLK | NC | V _{SS} | CEN | V _{SS} | NC | NC | NC | NC |
| L | DQh | DQh | V _{DDQ} | V _{DDQ} | V _{DD} | NC | V _{DD} | V _{DDQ} | V _{DDQ} | DQa | DQa |
| M | DQh | DQh | V _{SS} | V _{SS} | V _{SS} | NC | V _{SS} | V _{SS} | V _{SS} | DQa | DQa |
| N | DQh | DQh | V _{DDQ} | V _{DDQ} | V _{DD} | NC | V _{DD} | V _{DDQ} | V _{DDQ} | DQa | DQa |
| P | DQh | DQh | V _{SS} | V _{SS} | V _{SS} | ZZ | V _{SS} | V _{SS} | V _{SS} | DQa | DQa |
| R | DQPd | DQPd | V _{DDQ} | V _{DDQ} | V _{DD} | V _{DD} | V _{DD} | V _{DDQ} | V _{DDQ} | DQPd | DQPd |
| T | DQd | DQd | V _{SS} | NC | NC | MODE | NC | NC | V _{SS} | DQe | DQe |
| U | DQd | DQd | NC/144M | A | A | A | A | A | NC/288M | DQe | DQe |
| V | DQd | DQd | A | A | A | A1 | A | A | A | DQe | DQe |
| W | DQd | DQd | TMS | TDI | A | A0 | A | TDO | TCK | DQe | DQe |

Table 1. Pin Definitions

| Pin Name | IO Type | Pin Description |
|--|--------------------------------|---|
| A0 A1 A | Input-Synchronous | Address Inputs Used to Select One of the Address Locations. Sampled at the rising edge of the CLK. |
| \overline{BW}_a \overline{BW}_b \overline{BW}_c \overline{BW}_d \overline{BW}_e \overline{BW}_f \overline{BW}_g \overline{BW}_h | Input-Synchronous | Byte Write Select Inputs, Active LOW. Qualified with \overline{WE} to conduct writes to the SRAM. Sampled on the rising edge of CLK. \overline{BW}_a controls DQ_a and DQP_a , \overline{BW}_b controls DQ_b and DQP_b , \overline{BW}_c controls DQ_c and DQP_c , \overline{BW}_d controls DQ_d and DQP_d , \overline{BW}_e controls DQ_e and DQP_e , \overline{BW}_f controls DQ_f and DQP_f , \overline{BW}_g controls DQ_g and DQP_g , \overline{BW}_h controls DQ_h and DQP_h . |
| \overline{WE} | Input-Synchronous | Write Enable Input, Active LOW. Sampled on the rising edge of CLK if \overline{CEN} is active LOW. This signal must be asserted LOW to initiate a write sequence. |
| $\overline{ADV/LD}$ | Input-Synchronous | Advance/Load Input Used to Advance the On-Chip Address Counter or Load a New Address. When HIGH (and \overline{CEN} is asserted LOW) the internal burst counter is advanced. When LOW, a new address can be loaded into the device for an access. After being deselected, $\overline{ADV/LD}$ must be driven LOW to load a new address. |
| CLK | Input-Clock | Clock Input. Used to capture all synchronous inputs to the device. CLK is qualified with \overline{CEN} . CLK is only recognized if \overline{CEN} is active LOW. |
| \overline{CE}_1 | Input-Synchronous | Chip Enable 1 Input, Active LOW. Sampled on the rising edge of CLK. Used in conjunction with \overline{CE}_2 and \overline{CE}_3 to select/deselect the device. |
| \overline{CE}_2 | Input-Synchronous | Chip Enable 2 Input, Active HIGH. Sampled on the rising edge of CLK. Used in conjunction with \overline{CE}_1 and \overline{CE}_3 to select/deselect the device. |
| \overline{CE}_3 | Input-Synchronous | Chip Enable 3 Input, Active LOW. Sampled on the rising edge of CLK. Used in conjunction with \overline{CE}_1 and \overline{CE}_2 to select/deselect the device. |
| \overline{OE} | Input-Asynchronous | Output Enable, Active LOW. Combined with the synchronous logic block inside the device to control the direction of the IO pins. When LOW, the IO pins can behave as outputs. When deasserted HIGH, IO pins are tri-stated, and act as input data pins. \overline{OE} is masked during the data portion of a write sequence, during the first clock when emerging from a deselected state and when the device has been deselected. |
| \overline{CEN} | Input-Synchronous | Clock Enable Input, Active LOW. When asserted LOW the clock signal is recognized by the SRAM. When deasserted HIGH the clock signal is masked. Since deasserting \overline{CEN} does not deselect the device, \overline{CEN} can be used to extend the previous cycle when required. |
| DQ_s | IO-Synchronous | Bidirectional Data IO Lines. As inputs, they feed into an on-chip data register that is triggered by the rising edge of CLK. As outputs, they deliver the data contained in the memory location specified by $A_{[18:0]}$ during the previous clock rise of the read cycle. The direction of the pins is controlled by \overline{OE} and the internal control logic. When \overline{OE} is asserted LOW, the pins can behave as outputs. When HIGH, DQ_a – DQ_h are placed in a tri-state condition. The outputs are automatically tri-stated during the data portion of a write sequence, during the first clock when emerging from a deselected state, and when the device is deselected, regardless of the state of \overline{OE} . |
| DQP_x | IO-Synchronous | Bidirectional Data Parity IO Lines. Functionally, these signals are identical to $DQ_{[7:0]}$. During write sequences, DQP_a is controlled by \overline{BW}_a , DQP_b is controlled by \overline{BW}_b , DQP_c is controlled by \overline{BW}_c , and DQP_d is controlled by \overline{BW}_d , DQP_e is controlled by \overline{BW}_e , DQP_f is controlled by \overline{BW}_f , DQP_g is controlled by \overline{BW}_g , DQP_h is controlled by \overline{BW}_h . |
| MODE | Input Strap Pin | Mode Input. Selects the burst order of the device. Tied HIGH selects the interleaved burst order. Pulled LOW selects the linear burst order. MODE must not change states during operation. When left floating MODE defaults HIGH, to an interleaved burst order. |
| TDO | JTAG Serial Output Synchronous | Serial Data Out to the JTAG Circuit. Delivers data on the negative edge of TCK. |
| TDI | JTAG Serial Input Synchronous | Serial Data In to the JTAG Circuit. Sampled on the rising edge of TCK. |

Table 1. Pin Definitions (continued)

| Pin Name | IO Type | Pin Description |
|--------------------------|------------------------------|--|
| TMS | Test Mode Select Synchronous | TMS Pin Controls the Test Access Port State Machine. Sampled on the rising edge of TCK. |
| TCK | JTAG Clock | Clock Input to the JTAG Circuitry. |
| V _{DD} | Power Supply | Power Supply Inputs to the Core of the Device. |
| V _{DDQ} | IO Power Supply | Power Supply for the IO Circuitry. |
| V _{SS} | Ground | Ground for the Device. Must be connected to ground of the system. |
| NC | – | No Connects. This pin is not connected to the die. |
| NC(144M, 288M, 576M, 1G) | – | These Pins are Not Connected. They are used for expansion to the 144M, 288M, 576M, and 1G densities. |
| ZZ | Input-Asynchronous | ZZ “Sleep” Input. This active HIGH input places the device in a non-time critical “sleep” condition with data integrity preserved. For normal operation, this pin has must be LOW or left floating. ZZ pin has an internal pull down. |

Functional Overview

The CY7C1470BV25, CY7C1472BV25, and CY7C1474BV25 are synchronous-pipelined Burst NoBL SRAMs designed specifically to eliminate wait states during read or write transitions. All synchronous inputs pass through input registers controlled by the rising edge of the clock. The clock signal is qualified with the Clock Enable input signal (\overline{CEN}). If \overline{CEN} is HIGH, the clock signal is not recognized and all internal states are maintained. All synchronous operations are qualified with \overline{CEN} . All data outputs pass through output registers controlled by the rising edge of the clock. Maximum access delay from the clock rise (t_{CO}) is 3.0 ns (250-MHz device).

Accesses can be initiated by asserting all three Chip Enables (CE_1 , CE_2 , CE_3) active at the rising edge of the clock. If \overline{CEN} is active LOW and $\overline{ADV/LD}$ is asserted LOW, the address presented to the device is latched. The access can either be a read or write operation, depending on the status of the Write Enable (\overline{WE}). $BW_{[x]}$ can be used to conduct Byte Write operations.

Write operations are qualified by the Write Enable (\overline{WE}). All writes are simplified with on-chip synchronous self-timed write circuitry.

Three synchronous Chip Enables (\overline{CE}_1 , CE_2 , \overline{CE}_3) and an asynchronous Output Enable (\overline{OE}) simplify depth expansion. All operations (reads, writes, and deselections) are pipelined. $\overline{ADV/LD}$ must be driven LOW after the device is deselected to load a new address for the next operation.

Single Read Accesses

A read access is initiated when the following conditions are satisfied at clock rise: (1) \overline{CEN} is asserted LOW, (2) CE_1 , CE_2 , and CE_3 are ALL asserted active, (3) the input signal \overline{WE} is deasserted HIGH, and (4) $\overline{ADV/LD}$ is asserted LOW. The address presented to the address inputs is latched into the Address Register and presented to the memory core and control logic. The control logic determines that a read access is in progress and allows the requested data to propagate to the input of the output register. At the rising edge of the next clock the requested data is allowed to propagate through the output

register and onto the data bus within 2.6 ns (250-MHz device) provided \overline{OE} is active LOW. After the first clock of the read access the output buffers are controlled by \overline{OE} and the internal control logic. \overline{OE} must be driven LOW to drive out the requested data. During the second clock, a subsequent operation (read, write, or deselection) can be initiated. Deselecting the device is also pipelined. Therefore, when the SRAM is deselected at clock rise by one of the chip enable signals, its output tri-states following the next clock rise.

Burst Read Accesses

The CY7C1470BV25, CY7C1472BV25, and CY7C1474BV25 have an on-chip burst counter that enables the user to supply a single address and conduct up to four reads without reasserting the address inputs. $\overline{ADV/LD}$ must be driven LOW to load a new address into the SRAM, as described in the [Single Read Accesses](#) section. The sequence of the burst counter is determined by the MODE input signal. A LOW input on MODE selects a linear burst mode, a HIGH selects an interleaved burst sequence. Both burst counters use A0 and A1 in the burst sequence, and wraps around when incremented sufficiently. A HIGH input on $\overline{ADV/LD}$ increments the internal burst counter regardless of the state of chip enables inputs or \overline{WE} . \overline{WE} is latched at the beginning of a burst cycle. Therefore, the type of access (read or write) is maintained throughout the burst sequence.

Single Write Accesses

Write accesses are initiated when the following conditions are satisfied at clock rise: (1) \overline{CEN} is asserted LOW, (2) CE_1 , CE_2 , and CE_3 are ALL asserted active, and (3) the signal \overline{WE} is asserted LOW. The address presented to the address inputs is loaded into the Address Register. The write signals are latched into the Control Logic block.

On the subsequent clock rise the data lines are automatically tri-stated regardless of the state of the \overline{OE} input signal. This allows the external logic to present the data on DQ and DQP ($DQ_{a,b,c,d}/DQP_{a,b,c,d}$ for CY7C1470BV25, $DQ_{a,b}/DQP_{a,b}$ for CY7C1472BV25, and $DQ_{a,b,c,d,e,f,g,h}/DQP_{a,b,c,d,e,f,g,h}$ for CY7C1474BV25). In addition, the address for the subsequent

access (read, write, or deselect) is latched into the Address Register (provided the appropriate control signals are asserted).

On the next clock rise the data presented to DQ and DQP ($DQ_{a,b,c,d}/DQP_{a,b,c,d}$ for CY7C1470BV25, $DQ_{a,b}/DQP_{a,b}$ for CY7C1472BV25, $DQ_{a,b,c,d,e,f,g,h}/DQP_{a,b,c,d,e,f,g,h}$ for CY7C1474BV25) (or a subset for Byte Write operations, see “Partial Write Cycle Description” on page 11 for details) inputs is latched into the device and the Write is complete.

The data written during the Write operation is controlled by $\overline{BW}_{a,b,c,d}$ for CY7C1470BV25, $\overline{BW}_{a,b}$ for CY7C1472BV25, and $\overline{BW}_{a,b,c,d,e,f,g,h}$ for CY7C1474BV25 signals. The CY7C1470BV25, CY7C1472BV25, and CY7C1474BV25 provides Byte Write capability that is described in “Partial Write Cycle Description” on page 11. Asserting the WE input with the selected BW input selectively writes to only the desired bytes. Bytes not selected during a Byte Write operation remain unaltered. A synchronous self-timed write mechanism has been provided to simplify the write operations. Byte Write capability has been included to greatly simplify read, modify, or write sequences, which can be reduced to simple Byte Write operations.

Because the CY7C1470BV25, CY7C1472BV25, and CY7C1474BV25 are common IO devices, data must not be driven into the device while the outputs are active. \overline{OE} can be deasserted HIGH before presenting data to the DQ and DQP ($DQ_{a,b,c,d}/DQP_{a,b,c,d}$ for CY7C1470BV25, $DQ_{a,b}/DQP_{a,b}$ for CY7C1472BV25, and $DQ_{a,b,c,d,e,f,g,h}/DQP_{a,b,c,d,e,f,g,h}$ for CY7C1474BV25) inputs. Doing so tri-states the output drivers. As a safety precaution, DQ and DQP ($DQ_{a,b,c,d}/DQP_{a,b,c,d}$ for CY7C1470BV25, $DQ_{a,b}/DQP_{a,b}$ for CY7C1472BV25, and $DQ_{a,b,c,d,e,f,g,h}/DQP_{a,b,c,d,e,f,g,h}$ for CY7C1474BV25) are automatically tri-stated during the data portion of a write cycle, regardless of the state of \overline{OE} .

Burst Write Accesses

The CY7C1470BV25, CY7C1472BV25, and CY7C1474BV25 has an on-chip burst counter that enables the user to supply a single address and conduct up to four write operations without reasserting the address inputs. ADV/LD must be driven LOW to load the initial address, as described in “Single Write Accesses”

on page 8. When $\overline{ADV/LD}$ is driven HIGH on the subsequent clock rise, the Chip Enables (CE_1 , CE_2 , and CE_3) and WE inputs are ignored and the burst counter is incremented. The correct $\overline{BW}_{a,b,c,d}$ for CY7C1470BV25, $\overline{BW}_{a,b}$ for CY7C1472BV25, and $\overline{BW}_{a,b,c,d,e,f,g,h}$ for CY7C1474BV25) inputs must be driven in each cycle of the burst write to write the correct bytes of data.

Sleep Mode

The ZZ input pin is an asynchronous input. Asserting ZZ places the SRAM in a power conservation “sleep” mode. Two clock cycles are required to enter into or exit from this “sleep” mode. While in this mode, data integrity is guaranteed. Accesses pending when entering the “sleep” mode are not considered valid nor is the completion of the operation guaranteed. The device must be deselected before entering the “sleep” mode. CE_1 , CE_2 , and CE_3 , must remain inactive for the duration of t_{ZZREC} after the ZZ input returns LOW.

Table 2. Linear Burst Address Table (MODE = GND)

| First Address | Second Address | Third Address | Fourth Address |
|---------------|----------------|---------------|----------------|
| A1,A0 | A1,A0 | A1,A0 | A1,A0 |
| 00 | 01 | 10 | 11 |
| 01 | 10 | 11 | 00 |
| 10 | 11 | 00 | 01 |
| 11 | 00 | 01 | 10 |

Table 3. Interleaved Burst Address Table (MODE = Floating or V_{DD})

| First Address | Second Address | Third Address | Fourth Address |
|---------------|----------------|---------------|----------------|
| A1,A0 | A1,A0 | A1,A0 | A1,A0 |
| 00 | 01 | 10 | 11 |
| 01 | 00 | 11 | 10 |
| 10 | 11 | 00 | 01 |
| 11 | 10 | 01 | 00 |

ZZ Mode Electrical Characteristics

| Parameter | Description | Test Conditions | Min | Max | Unit |
|-------------|-----------------------------------|---------------------------|------------|------------|------|
| I_{DDZZ} | Sleep mode standby current | $ZZ \geq V_{DD} - 0.2V$ | | 120 | mA |
| t_{ZZS} | Device operation to ZZ | $ZZ \geq V_{DD} - 0.2V$ | | $2t_{CYC}$ | ns |
| t_{ZZREC} | ZZ recovery time | $ZZ \leq 0.2V$ | $2t_{CYC}$ | | ns |
| t_{ZZI} | ZZ active to sleep current | This parameter is sampled | | $2t_{CYC}$ | ns |
| t_{RZZI} | ZZ Inactive to exit sleep current | This parameter is sampled | 0 | | ns |

Table 4. Truth Table

The truth table for CY7C1470BV25, CY7C1472BV25, and CY7C1474BV25 follows. [1, 2, 3, 4, 5, 6, 7]

| Operation | Address Used | \overline{CE} | ZZ | ADV/LD | \overline{WE} | \overline{BW}_x | \overline{OE} | \overline{CEN} | CLK | DQ |
|-------------------------------|--------------|-----------------|----|--------|-----------------|-------------------|-----------------|------------------|-----|--------------|
| Deselect Cycle | None | H | L | L | X | X | X | L | L-H | Tri-State |
| Continue Deselect Cycle | None | X | L | H | X | X | X | L | L-H | Tri-State |
| Read Cycle (Begin Burst) | External | L | L | L | H | X | L | L | L-H | Data Out (Q) |
| Read Cycle (Continue Burst) | Next | X | L | H | X | X | L | L | L-H | Data Out (Q) |
| NOP/Dummy Read (Begin Burst) | External | L | L | L | H | X | H | L | L-H | Tri-State |
| Dummy Read (Continue Burst) | Next | X | L | H | X | X | H | L | L-H | Tri-State |
| Write Cycle (Begin Burst) | External | L | L | L | L | L | X | L | L-H | Data In (D) |
| Write Cycle (Continue Burst) | Next | X | L | H | X | L | X | L | L-H | Data In (D) |
| NOP/Write Abort (Begin Burst) | None | L | L | L | L | H | X | L | L-H | Tri-State |
| Write Abort (Continue Burst) | Next | X | L | H | X | H | X | L | L-H | Tri-State |
| Ignore Clock Edge (Stall) | Current | X | L | X | X | X | X | H | L-H | – |
| Sleep Mode | None | X | H | X | X | X | X | X | X | Tri-State |

Notes

1. X = "Don't Care", H = Logic HIGH, L = Logic LOW, \overline{CE} stands for ALL Chip Enables active. $\overline{BW}_x = L$ signifies at least one Byte Write Select is active, $\overline{BW}_x = \text{Valid}$ signifies that the desired Byte Write Selects are asserted, see "Partial Write Cycle Description" on page 11 for details.
2. Write is defined by \overline{WE} and $\overline{BW}_{[a,d]}$. See "Partial Write Cycle Description" on page 11 for details.
3. When a write cycle is detected, all IOs are tri-stated, even during Byte Writes.
4. The DQ and DQP pins are controlled by the current cycle and the \overline{OE} signal.
5. $\overline{CEN} = H$ inserts wait states.
6. Device powers up deselected with the IOs in a tri-state condition, regardless of \overline{OE} .
7. \overline{OE} is asynchronous and is not sampled with the clock rise. It is masked internally during write cycles. During a Read cycle DQ_s and $DQP_{[a,d]}$ = tri-state when \overline{OE} is inactive or when the device is deselected, and DQ_s = data when \overline{OE} is active.

Table 5. Partial Write Cycle Description

The partial write cycle description for CY7C1470BV25, CY7C1472BV25, and CY7C1474BV25 follows.^[1, 2, 3, 8]

| Function (CY7C1470BV25) | \overline{WE} | \overline{BW}_d | \overline{BW}_c | \overline{BW}_b | \overline{BW}_a |
|--|-----------------|-------------------|-------------------|-------------------|-------------------|
| Read | H | X | X | X | X |
| Write – No bytes written | L | H | H | H | H |
| Write Byte a – (DQ _a and DQP _a) | L | H | H | H | L |
| Write Byte b – (DQ _b and DQP _b) | L | H | H | L | H |
| Write Bytes b, a | L | H | H | L | L |
| Write Byte c – (DQ _c and DQP _c) | L | H | L | H | H |
| Write Bytes c, a | L | H | L | H | L |
| Write Bytes c, b | L | H | LL | L | H |
| Write Bytes c, b, a | L | H | L | L | L |
| Write Byte d – (DQ _d and DQP _d) | L | L | H | H | H |
| Write Bytes d, a | L | L | H | H | L |
| Write Bytes d, b | L | L | H | L | H |
| Write Bytes d, b, a | L | L | H | L | L |
| Write Bytes d, c | L | L | L | H | H |
| Write Bytes d, c, a | L | L | L | H | L |
| Write Bytes d, c, b | L | L | L | L | H |
| Write All Bytes | L | L | L | L | L |

| Function (CY7C1472BV25) | \overline{WE} | \overline{BW}_b | \overline{BW}_a |
|--|-----------------|-------------------|-------------------|
| Read | H | x | x |
| Write – No Bytes Written | L | H | H |
| Write Byte a – (DQ _a and DQP _a) | L | H | L |
| Write Byte b – (DQ _b and DQP _b) | L | L | H |
| Write Both Bytes | L | L | L |

| Function (CY7C1474BV25) | \overline{WE} | \overline{BW}_x |
|--|-----------------|-------------------------|
| Read | H | x |
| Write – No Bytes Written | L | H |
| Write Byte X – (DQ _x and DQP _x) | L | L |
| Write All Bytes | L | All $\overline{BW} = L$ |

Note

8. Table lists only a partial listing of the Byte Write combinations. Any combination of $\overline{BW}_{[a:d]}$ is valid. Appropriate write is based on which Byte Write is active.

IEEE 1149.1 Serial Boundary Scan (JTAG)

The CY7C1470BV25, CY7C1472BV25, and CY7C1474BV25 incorporates a serial boundary scan test access port (TAP). This port operates in accordance with IEEE Standard 1149.1-1990 but does not have the set of functions required for full 1149.1 compliance. These functions from the IEEE specification are excluded because their inclusion places an added delay in the critical speed path of the SRAM. Note that the TAP controller functions in a manner that does not conflict with the operation of other devices using 1149.1 fully compliant TAPs. The TAP operates using JEDEC-standard 2.5V IO logic levels.

The CY7C1470BV25, CY7C1472BV25, and CY7C1474BV25 contains a TAP controller, instruction register, boundary scan register, bypass register, and ID register.

Disabling the JTAG Feature

It is possible to operate the SRAM without using the JTAG feature. To disable the TAP controller, TCK must be tied LOW (V_{SS}) to prevent clocking of the device. TDI and TMS are internally pulled up and may be unconnected. They may alternately be connected to V_{DD} through a pull up resistor. TDO must be left unconnected. During power up, the device comes up in a reset state, which does not interfere with the operation of the device.

Figure 2. TAP Controller State Diagram

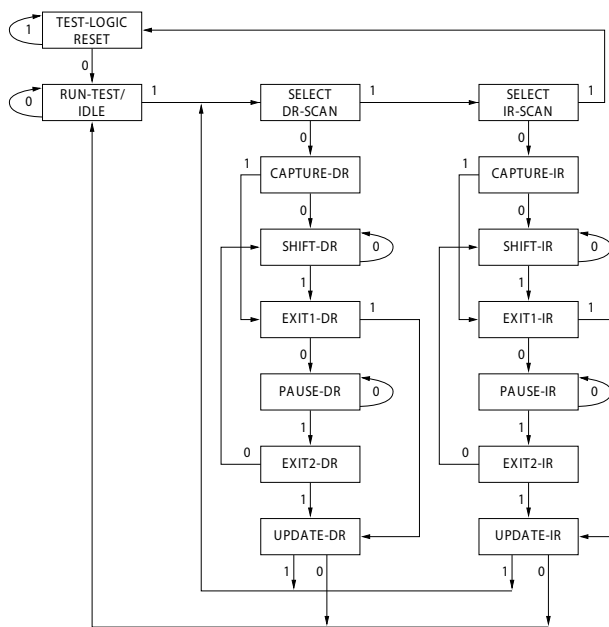

The 0/1 next to each state represents the value of TMS at the rising edge of TCK.

Test Access Port (TAP)

Test Clock (TCK)

The test clock is used only with the TAP controller. All inputs are captured on the rising edge of TCK. All outputs are driven from the falling edge of TCK.

Test MODE SELECT (TMS)

The TMS input is used to give commands to the TAP controller and is sampled on the rising edge of TCK. It is allowable to leave this ball unconnected if the TAP is not used. The ball is pulled up internally, resulting in a logic HIGH level.

Test Data-In (TDI)

The TDI ball is used to serially input information into the registers and can be connected to the input of any of the registers. The register between TDI and TDO is chosen by the instruction that is loaded into the TAP instruction register. For information about loading the instruction register, see the [TAP Controller State Diagram](#). TDI is internally pulled up and can be unconnected if the TAP is unused in an application. TDI is connected to the most significant bit (MSB) of any register. (See [TAP Controller Block Diagram](#).)

Test Data-Out (TDO)

The TDO output ball is used to serially clock data-out from the registers. The output is active depending upon the current state of the TAP state machine. The output changes on the falling edge of TCK. TDO is connected to the least significant bit (LSB) of any register. (See [TAP Controller State Diagram](#).)

Figure 3. TAP Controller Block Diagram

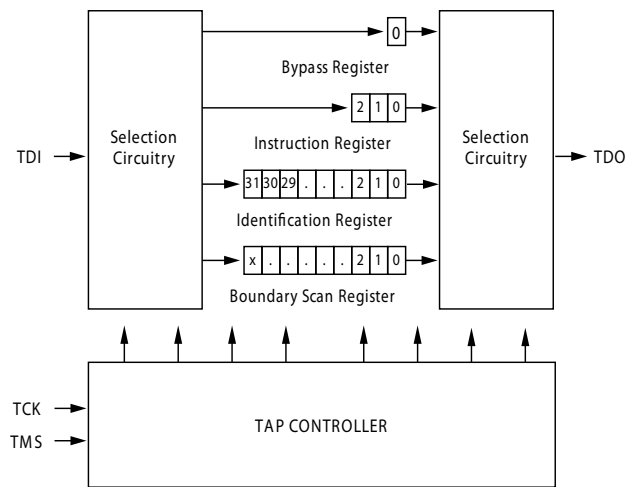

Performing a TAP Reset

A RESET is performed by forcing TMS HIGH (V_{DD}) for five rising edges of TCK. This RESET does not affect the operation of the SRAM and may be performed while the SRAM is operating.

During power up, the TAP is reset internally to ensure that TDO comes up in a High-Z state.

TAP Registers

Registers are connected between the TDI and TDO balls to scan the data in and out of the SRAM test circuitry. Only one register can be selected at a time through the instruction register. Data is serially loaded into the TDI ball on the rising edge of TCK. Data is output on the TDO ball on the falling edge of TCK.

Instruction Register

Three-bit instructions can be serially loaded into the instruction register. This register is loaded when it is placed between the TDI and TDO balls as shown in the [“TAP Controller Block Diagram” on page 12](#). During power up, the instruction register is loaded with the IDCODE instruction. It is also loaded with the IDCODE instruction if the controller is placed in a reset state as described in the previous section.

When the TAP controller is in the Capture-IR state, the two least significant bits are loaded with a binary ‘01’ pattern to enable fault isolation of the board-level serial test data path.

Bypass Register

To save time when serially shifting data through registers, it is sometimes advantageous to skip certain chips. The bypass register is a single-bit register that can be placed between the TDI and TDO balls. This shifts the data through the SRAM with minimal delay. The bypass register is set LOW (V_{SS}) when the BYPASS instruction is executed.

Boundary Scan Register

The boundary scan register is connected to all the input and bidirectional balls on the SRAM.

The boundary scan register is loaded with the contents of the RAM IO ring when the TAP controller is in the Capture-DR state and is then placed between the TDI and TDO balls when the controller is moved to the Shift-DR state. The EXTEST, SAMPLE/PRELOAD and SAMPLE Z instructions can be used to capture the contents of the IO ring.

The [Boundary Scan Order tables on page 17](#) show the order in which the bits are connected. Each bit corresponds to one of the bumps on the SRAM package. The MSB of the register is connected to TDI and the LSB is connected to TDO.

Identification (ID) Register

The ID register is loaded with a vendor-specific, 32-bit code during the Capture-DR state when the IDCODE command is loaded in the instruction register. The IDCODE is hardwired into the SRAM and can be shifted out when the TAP controller is in the Shift-DR state. The ID register has a vendor code and other information described in [“Identification Register Definitions” on page 16](#).

TAP Instruction Set

Overview

Eight different instructions are possible with the three-bit instruction register. All combinations are listed in [“Identification Codes” on page 17](#). Three of these instructions are listed as RESERVED and must not be used. The other five instructions are described in this section in detail.

The TAP controller used in this SRAM is not fully compliant to the 1149.1 convention because some of the mandatory 1149.1 instructions are not fully implemented.

The TAP controller cannot be used to load address data or control signals into the SRAM and cannot preload the IO buffers. The SRAM does not implement the 1149.1 commands EXTEST or INTEST or the PRELOAD portion of SAMPLE/PRELOAD; rather, it performs a capture of the IO ring when these instructions are executed.

Instructions are loaded into the TAP controller during the Shift-IR state when the instruction register is placed between TDI and TDO. During this state, instructions are shifted through the instruction register through the TDI and TDO balls. To execute the instruction after it is shifted in, the TAP controller must be moved into the Update-IR state.

EXTEST

EXTEST is a mandatory 1149.1 instruction which is executed whenever the instruction register is loaded with all 0s. EXTEST is not implemented in this SRAM TAP controller, and therefore this device is not compliant to 1149.1. The TAP controller does recognize an all-0 instruction.

When an EXTEST instruction is loaded into the instruction register, the SRAM responds as if a SAMPLE/PRELOAD instruction has been loaded. There is one difference between the two instructions. Unlike the SAMPLE/PRELOAD instruction, EXTEST places the SRAM outputs in a High-Z state.

IDCODE

The IDCODE instruction loads a vendor-specific, 32-bit code into the instruction register. It also places the instruction register between the TDI and TDO balls and shifts the IDCODE out of the device when the TAP controller enters the Shift-DR state.

The IDCODE instruction is loaded into the instruction register during power up or whenever the TAP controller is in a test logic reset state.

SAMPLE Z

The SAMPLE Z instruction connects the boundary scan register between the TDI and TDO pins when the TAP controller is in a Shift-DR state. It also places all SRAM outputs into a High-Z state.

SAMPLE/PRELOAD

SAMPLE/PRELOAD is a 1149.1 mandatory instruction. The PRELOAD portion of this instruction is not implemented, so the device TAP controller is not fully 1149.1 compliant.

When the SAMPLE/PRELOAD instruction is loaded into the instruction register and the TAP controller is in the Capture-DR state, a snapshot of data on the inputs and bidirectional balls is captured in the boundary scan register.

The user must be aware that the TAP controller clock can only operate at a frequency up to 20 MHz, while the SRAM clock operates more than an order of magnitude faster. Because there is a large difference in the clock frequencies, it is possible that during the Capture-DR state, an input or output may undergo a transition. The TAP may then try to capture a signal while in transition (metastable state). This does not harm the device, but there is no guarantee as to the value that is captured. Repeatable results may not be possible.

To guarantee that the boundary scan register captures the correct value of a signal, the SRAM signal must be stabilized long enough to meet the TAP controller’s capture setup plus hold time (t_{CS} plus t_{CH}).

The SRAM clock input might not be captured correctly if there is no way in a design to stop (or slow) the clock during a SAMPLE/PRELOAD instruction. If this is an issue, it is still

possible to capture all other signals and simply ignore the value of the CLK captured in the boundary scan register.

After the data is captured, it is possible to shift out the data by putting the TAP into the Shift-DR state. This places the boundary scan register between the TDI and TDO balls.

Note that since the PRELOAD part of the command is not implemented, putting the TAP to the Update-DR state while performing a SAMPLE/PRELOAD instruction has the same effect as the Pause-DR command.

BYPASS

When the BYPASS instruction is loaded in the instruction register and the TAP is placed in a Shift-DR state, the bypass register is placed between the TDI and TDO balls. The advantage of the BYPASS instruction is that it shortens the boundary scan path when multiple devices are connected together on a board.

Reserved

These instructions are not implemented but are reserved for future use. Do not use these instructions.

Figure 4. TAP Timing

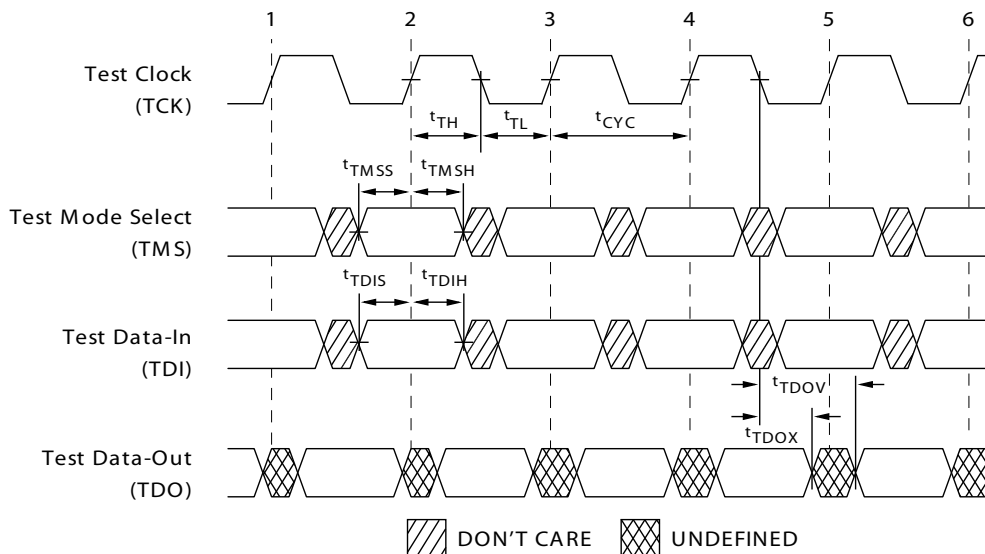

TAP AC Switching Characteristics

Over the Operating Range [9, 10]

| Parameter | Description | Min | Max | Unit |
|---------------------|-------------------------------|-----|-----|------|
| Clock | | | | |
| t_{TCYC} | TCK Clock Cycle Time | 50 | | ns |
| t_{TF} | TCK Clock Frequency | | 20 | MHz |
| t_{TH} | TCK Clock HIGH time | 20 | | ns |
| t_{TL} | TCK Clock LOW time | 20 | | ns |
| Output Times | | | | |
| t_{TDOV} | TCK Clock LOW to TDO Valid | | 10 | ns |
| t_{TDOX} | TCK Clock LOW to TDO Invalid | 0 | | ns |
| Setup Times | | | | |
| t_{TMSS} | TMS Setup to TCK Clock Rise | 5 | | ns |
| t_{TDIS} | TDI Setup to TCK Clock Rise | 5 | | ns |
| t_{CS} | Capture Setup to TCK Rise | 5 | | ns |
| Hold Times | | | | |
| t_{TMSh} | TMS Hold after TCK Clock Rise | 5 | | ns |
| t_{TDIH} | TDI Hold after Clock Rise | 5 | | ns |
| t_{CH} | Capture Hold after Clock Rise | 5 | | ns |

Notes

9. t_{CS} and t_{CH} refer to the setup and hold time requirements of latching data from the boundary scan register.
 10. Test conditions are specified using the load in TAP AC Test Conditions. $t_R/t_F = 1$ ns.

2.5V TAP AC Test Conditions

Input pulse levels..... V_{SS} to 2.5V
 Input rise and fall time 1 ns
 Input timing reference levels..... 1.25V
 Output reference levels 1.25V
 Test load termination supply voltage 1.25V

Figure 5. 2.5V TAP AC Output Load Equivalent

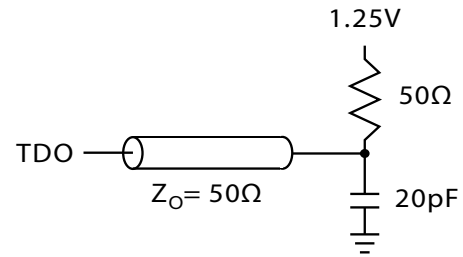

TAP DC Electrical Characteristics And Operating Conditions

($0^{\circ}\text{C} < T_A < +70^{\circ}\text{C}$; $V_{DD} = 2.5\text{V} \pm 0.125\text{V}$ unless otherwise noted)^[11]

| Parameter | Description | Test Conditions | Min | Max | Unit |
|-----------|---------------------|--|------|----------------|---------------|
| V_{OH1} | Output HIGH Voltage | $I_{OH} = -1.0\text{ mA}$, $V_{DDQ} = 2.5\text{V}$ | 1.7 | | V |
| V_{OH2} | Output HIGH Voltage | $I_{OH} = -100\ \mu\text{A}$, $V_{DDQ} = 2.5\text{V}$ | 2.1 | | V |
| V_{OL1} | Output LOW Voltage | $I_{OL} = 1.0\text{ mA}$, $V_{DDQ} = 2.5\text{V}$ | | 0.4 | V |
| V_{OL2} | Output LOW Voltage | $I_{OL} = 100\ \mu\text{A}$, $V_{DDQ} = 2.5\text{V}$ | | 0.2 | V |
| V_{IH} | Input HIGH Voltage | $V_{DDQ} = 2.5\text{V}$ | 1.7 | $V_{DD} + 0.3$ | V |
| V_{IL} | Input LOW Voltage | $V_{DDQ} = 2.5\text{V}$ | -0.3 | 0.7 | V |
| I_X | Input Load Current | $\text{GND} \leq V_I \leq V_{DDQ}$ | -5 | 5 | μA |

Table 6. Identification Register Definitions

| Instruction Field | CY7C1470BV25 (2M x 36) | CY7C1472BV25 (4M x 18) | CY7C1474BV25 (1M x 72) | Description |
|------------------------------------|---------------------------|---------------------------|---------------------------|---|
| Revision Number (31:29) | 000 | 000 | 000 | Describes the version number |
| Device Depth (28:24) | 01011 | 01011 | 01011 | Reserved for internal use |
| Architecture/Memory Type(23:18) | 001000 | 001000 | 001000 | Defines memory type and architecture |
| Bus Width/Density(17:12) | 100100 | 010100 | 110100 | Defines width and density |
| Cypress JEDEC ID Code (11:1) | 00000110100 | 00000110100 | 00000110100 | Allows unique identification of SRAM vendor |
| ID Register Presence Indicator (0) | 1 | 1 | 1 | Indicates the presence of an ID register |

Table 7. Scan Register Sizes

| Register Name | Bit Size (x36) | Bit Size (x18) | Bit Size (x72) |
|-----------------------------|----------------|----------------|----------------|
| Instruction | 3 | 3 | 3 |
| Bypass | 1 | 1 | 1 |
| ID | 32 | 32 | 32 |
| Boundary Scan Order-165FBGA | 71 | 52 | - |
| Boundary Scan Order-209BGA | - | - | 110 |

Note

11. All voltages refer to V_{SS} (GND).

Table 8. Identification Codes

| Instruction | Code | Description |
|----------------|------|--|
| EXTEST | 000 | Captures IO ring contents. Places the boundary scan register between TDI and TDO. Forces all SRAM outputs to High-Z state. This instruction is not 1149.1-compliant. |
| IDCODE | 001 | Loads the ID register with the vendor ID code and places the register between TDI and TDO. This operation does not affect SRAM operations. |
| SAMPLE Z | 010 | Captures IO ring contents. Places the boundary scan register between TDI and TDO. Forces all SRAM output drivers to a High-Z state. |
| RESERVED | 011 | Do Not Use: This instruction is reserved for future use. |
| SAMPLE/PRELOAD | 100 | Captures IO ring contents. Places the boundary scan register between TDI and TDO. Does not affect SRAM operation. This instruction does not implement 1149.1 preload function and is therefore not 1149.1-compliant. |
| RESERVED | 101 | Do Not Use: This instruction is reserved for future use. |
| RESERVED | 110 | Do Not Use: This instruction is reserved for future use. |
| BYPASS | 111 | Places the bypass register between TDI and TDO. This operation does not affect SRAM operations. |

Table 9. Boundary Scan Exit Order (2M x 36)

| Bit # | 165-Ball ID | Bit # | 165-Ball ID | Bit # | 165-Ball ID | Bit # | 165-Ball ID |
|-------|-------------|-------|-------------|-------|-------------|-------|-------------|
| 1 | C1 | 21 | R3 | 41 | J11 | 61 | B7 |
| 2 | D1 | 22 | P2 | 42 | K10 | 62 | B6 |
| 3 | E1 | 23 | R4 | 43 | J10 | 63 | A6 |
| 4 | D2 | 24 | P6 | 44 | H11 | 64 | B5 |
| 5 | E2 | 25 | R6 | 45 | G11 | 65 | A5 |
| 6 | F1 | 26 | R8 | 46 | F11 | 66 | A4 |
| 7 | G1 | 27 | P3 | 47 | E11 | 67 | B4 |
| 8 | F2 | 28 | P4 | 48 | D10 | 68 | B3 |
| 9 | G2 | 29 | P8 | 49 | D11 | 69 | A3 |
| 10 | J1 | 30 | P9 | 50 | C11 | 70 | A2 |
| 11 | K1 | 31 | P10 | 51 | G10 | 71 | B2 |
| 12 | L1 | 32 | R9 | 52 | F10 | | |
| 13 | J2 | 33 | R10 | 53 | E10 | | |
| 14 | M1 | 34 | R11 | 54 | A9 | | |
| 15 | N1 | 35 | N11 | 55 | B9 | | |
| 16 | K2 | 36 | M11 | 56 | A10 | | |
| 17 | L2 | 37 | L11 | 57 | B10 | | |
| 18 | M2 | 38 | M10 | 58 | A8 | | |
| 19 | R1 | 39 | L10 | 59 | B8 | | |
| 20 | R2 | 40 | K11 | 60 | A7 | | |

Boundary Scan Exit Order (4M x 18)

| Bit # | 165-Ball ID |
|-------|-------------|
| 1 | D2 |
| 2 | E2 |
| 3 | F2 |
| 4 | G2 |
| 5 | J1 |
| 6 | K1 |
| 7 | L1 |
| 8 | M1 |
| 9 | N1 |
| 10 | R1 |
| 11 | R2 |
| 12 | R3 |
| 13 | P2 |

| Bit # | 165-Ball ID |
|-------|-------------|
| 14 | R4 |
| 15 | P6 |
| 16 | R6 |
| 17 | R8 |
| 18 | P3 |
| 19 | P4 |
| 20 | P8 |
| 21 | P9 |
| 22 | P10 |
| 23 | R9 |
| 24 | R10 |
| 25 | R11 |
| 26 | M10 |

| Bit # | 165-Ball ID |
|-------|-------------|
| 27 | L10 |
| 28 | K10 |
| 29 | J10 |
| 30 | H11 |
| 31 | G11 |
| 32 | F11 |
| 33 | E11 |
| 34 | D11 |
| 35 | C11 |
| 36 | A11 |
| 37 | A9 |
| 38 | B9 |
| 39 | A10 |

| Bit # | 165-Ball ID |
|-------|-------------|
| 40 | B10 |
| 41 | A8 |
| 42 | B8 |
| 43 | A7 |
| 44 | B7 |
| 45 | B6 |
| 46 | A6 |
| 47 | B5 |
| 48 | A4 |
| 49 | B3 |
| 50 | A3 |
| 51 | A2 |
| 52 | B2 |

Boundary Scan Exit Order (1M x 72)

| Bit # | 209-Ball ID |
|-------|-------------|
| 1 | A1 |
| 2 | A2 |
| 3 | B1 |
| 4 | B2 |
| 5 | C1 |
| 6 | C2 |
| 7 | D1 |
| 8 | D2 |
| 9 | E1 |
| 10 | E2 |
| 11 | F1 |
| 12 | F2 |
| 13 | G1 |
| 14 | G2 |
| 15 | H1 |
| 16 | H2 |
| 17 | J1 |
| 18 | J2 |
| 19 | L1 |
| 20 | L2 |
| 21 | M1 |
| 22 | M2 |
| 23 | N1 |
| 24 | N2 |
| 25 | P1 |
| 26 | P2 |
| 27 | R2 |
| 28 | R1 |

| Bit # | 209-Ball ID |
|-------|-------------|
| 29 | T1 |
| 30 | T2 |
| 31 | U1 |
| 32 | U2 |
| 33 | V1 |
| 34 | V2 |
| 35 | W1 |
| 36 | W2 |
| 37 | T6 |
| 38 | V3 |
| 39 | V4 |
| 40 | U4 |
| 41 | W5 |
| 42 | V6 |
| 43 | W6 |
| 44 | V5 |
| 45 | U5 |
| 46 | U6 |
| 47 | W7 |
| 48 | V7 |
| 49 | U7 |
| 50 | V8 |
| 51 | V9 |
| 52 | W11 |
| 53 | W10 |
| 54 | V11 |
| 55 | V10 |
| 56 | U11 |

| Bit # | 209-Ball ID |
|-------|-------------|
| 57 | U10 |
| 58 | T11 |
| 59 | T10 |
| 60 | R11 |
| 61 | R10 |
| 62 | P11 |
| 63 | P10 |
| 64 | N11 |
| 65 | N10 |
| 66 | M11 |
| 67 | M10 |
| 68 | L11 |
| 69 | L10 |
| 70 | P6 |
| 71 | J11 |
| 72 | J10 |
| 73 | H11 |
| 74 | H10 |
| 75 | G11 |
| 76 | G10 |
| 77 | F11 |
| 78 | F10 |
| 79 | E10 |
| 80 | E11 |
| 81 | D11 |
| 82 | D10 |
| 83 | C11 |
| 84 | C10 |

| Bit # | 209-Ball ID |
|-------|-------------|
| 85 | B11 |
| 86 | B10 |
| 87 | A11 |
| 88 | A10 |
| 89 | A7 |
| 90 | A5 |
| 91 | A9 |
| 92 | U8 |
| 93 | A6 |
| 94 | D6 |
| 95 | K6 |
| 96 | B6 |
| 97 | K3 |
| 98 | A8 |
| 99 | B4 |
| 100 | B3 |
| 101 | C3 |
| 102 | C4 |
| 103 | C8 |
| 104 | C9 |
| 105 | B9 |
| 106 | B8 |
| 107 | A4 |
| 108 | C6 |
| 109 | B7 |
| 110 | A3 |

Maximum Ratings

Exceeding maximum ratings may impair the useful life of the device. These user guidelines are not tested.

Storage Temperature -65°C to +150°C
 Ambient Temperature with
 Power Applied -55°C to +125°C
 Supply Voltage on V_{DD} Relative to GND -0.5V to +3.6V
 Supply Voltage on V_{DDQ} Relative to GND -0.5V to +V_{DD}
 DC to Outputs in Tri-State -0.5V to V_{DDQ} + 0.5V
 DC Input Voltage -0.5V to V_{DD} + 0.5V

Current into Outputs (LOW) 20 mA
 Static Discharge Voltage > 2001V
 (MIL-STD-883, Method 3015)
 Latch up Current > 200 mA

Operating Range

| Range | Ambient Temperature | V _{DD} | V _{DDQ} |
|------------|---------------------|-----------------|----------------------------|
| Commercial | 0°C to +70°C | 2.5V -5%/+5% | 2.5V-5% to V _{DD} |
| Industrial | -40°C to +85°C | | |

Electrical Characteristics

Over the Operating Range^[12, 13]

| Parameter | Description | Test Conditions | Min | Max | Unit | |
|---------------------------------|---|--|-------------------------|------------------------|------|----|
| V _{DD} | Power Supply Voltage | | 2.375 | 2.625 | V | |
| V _{DDQ} | IO Supply Voltage | For 2.5V IO | 2.375 | V _{DD} | V | |
| V _{OH} | Output HIGH Voltage | For 2.5V IO, I _{OH} = -1.0 mA | 2.0 | | V | |
| V _{OL} | Output LOW Voltage | For 2.5V IO, I _{OL} = 1.0 mA | | 0.4 | V | |
| V _{IH} | Input HIGH Voltage ^[12] | For 2.5V IO | 1.7 | V _{DD} + 0.3V | V | |
| V _{IL} | Input LOW Voltage ^[12] | For 2.5V IO | -0.3 | 0.7 | V | |
| I _X | Input Leakage Current except ZZ and MODE | GND ≤ V _I ≤ V _{DDQ} | -5 | 5 | μA | |
| | | Input Current of MODE | Input = V _{SS} | -30 | | μA |
| | | | Input = V _{DD} | | 5 | μA |
| | | Input Current of ZZ | Input = V _{SS} | -5 | | μA |
| Input = V _{DD} | | | 30 | μA | | |
| I _{OZ} | Output Leakage Current | GND ≤ V _I ≤ V _{DDQ} , Output Disabled | -5 | 5 | μA | |
| I _{DD} ^[14] | V _{DD} Operating Supply | V _{DD} = Max, I _{OUT} = 0 mA, f = f _{MAX} = 1/t _{CYC} | 4.0-ns cycle, 250 MHz | 450 | mA | |
| | | | 5.0-ns cycle, 200 MHz | 450 | mA | |
| | | | 6.0-ns cycle, 167 MHz | 400 | mA | |
| I _{SB1} | Automatic CE Power Down Current—TTL Inputs | Max. V _{DD} , Device Deselected, V _{IN} ≥ V _{IH} or V _{IN} ≤ V _{IL} , f = f _{MAX} = 1/t _{CYC} | 4.0-ns cycle, 250MHz | 200 | mA | |
| | | | 5.0-ns cycle, 200 MHz | 200 | mA | |
| | | | 6.0-ns cycle, 167 MHz | 200 | mA | |
| I _{SB2} | Automatic CE Power Down Current—CMOS Inputs | Max. V _{DD} , Device Deselected, V _{IN} ≤ 0.3V or V _{IN} ≥ V _{DDQ} - 0.3V, f = 0 | | 120 | mA | |

Notes

12. Overshoot: V_{IH}(AC) < V_{DD} + 1.5V (pulse width less than t_{CYC}/2). Undershoot: V_{IL}(AC) > -2V (pulse width less than t_{CYC}/2).
13. T_{Power-up}: assumes a linear ramp from 0V to V_{DD} (min.) within 200 ms. During this time V_{IH} < V_{DD} and V_{DDQ} ≤ V_{DD}.
14. The operation current is calculated with 50% read cycle and 50% write cycle.

Electrical Characteristics

Over the Operating Range^[12, 13] (continued)

| Parameter | Description | Test Conditions | Min | Max | Unit | |
|-----------|---|---|-----------------------|-----|------|----|
| I_{SB3} | Automatic CE Power Down Current—CMOS Inputs | Max. V_{DD} , Device Deselected, $V_{IN} \leq 0.3V$ or $V_{IN} \geq V_{DDQ} - 0.3V$, $f = f_{MAX} = 1/t_{CYC}$ | 4.0-ns cycle, 250 MHz | | 200 | mA |
| | | | 5.0-ns cycle, 200 MHz | | 200 | mA |
| | | | 6.0-ns cycle, 167 MHz | | 200 | mA |
| I_{SB4} | Automatic CE Power Down Current—TTL Inputs | Max. V_{DD} , Device Deselected, $V_{IN} \geq V_{IH}$ or $V_{IN} \leq V_{IL}$, $f = 0$ | All speed grades | | 135 | mA |

Capacitance

Tested initially and after any design or process changes that may affect these parameters.

| Parameter | Description | Test Conditions | 100 TQFP Max | 165 FBGA Max | 209 FBGA Max | Unit |
|---------------|---------------------------|--|--------------|--------------|--------------|------|
| $C_{ADDRESS}$ | Address Input Capacitance | $T_A = 25^\circ C$, $f = 1$ MHz, $V_{DD} = 2.5V$, $V_{DDQ} = 2.5V$ | 6 | 6 | 6 | pF |
| C_{DATA} | Data Input Capacitance | | 5 | 5 | 5 | pF |
| C_{CTRL} | Control Input Capacitance | | 8 | 8 | 8 | pF |
| C_{CLK} | Clock Input Capacitance | | 6 | 6 | 6 | pF |
| C_{IO} | Input/Output Capacitance | | 5 | 5 | 5 | pF |

Thermal Resistance

Tested initially and after any design or process changes that may affect these parameters.

| Parameter | Description | Test Conditions | 100 TQFP Package | 165 FBGA Package | 209 FBGA Package | Unit |
|---------------|--|--|------------------|------------------|------------------|--------------|
| Θ_{JA} | Thermal Resistance (Junction to Ambient) | Test conditions follow standard test methods and procedures for measuring thermal impedance, per EIA/JESD51. | 24.63 | 16.3 | 15.2 | $^\circ C/W$ |
| Θ_{JC} | Thermal Resistance (Junction to Case) | | 2.28 | 2.1 | 1.7 | $^\circ C/W$ |

AC Test Loads and Waveforms

2.5V IO Test Load

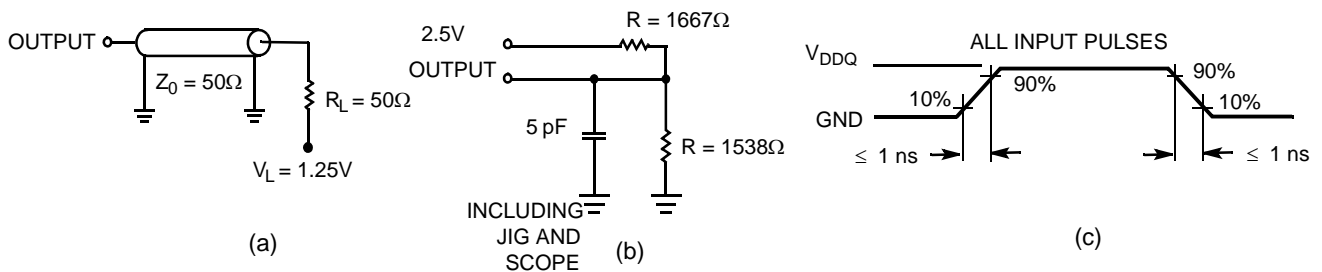

Switching Characteristics

Over the Operating Range. Timing reference is 1.25V when $V_{DDQ} = 2.5V$. Test conditions shown in (a) of "AC Test Loads and Waveforms" on page 20 unless otherwise noted.

| Parameter | Description | -250 | | -200 | | -167 | | Unit |
|---------------------|--|------|-----|------|-----|------|-----|------|
| | | Min | Max | Min | Max | Min | Max | |
| $t_{Power}^{[15]}$ | V_{CC} (typical) to the First Access Read or Write | 1 | | 1 | | 1 | | ms |
| Clock | | | | | | | | |
| t_{CYC} | Clock Cycle Time | 4.0 | | 5.0 | | 6.0 | | ns |
| F_{MAX} | Maximum Operating Frequency | | 250 | | 200 | | 167 | MHz |
| t_{CH} | Clock HIGH | 2.0 | | 2.0 | | 2.2 | | ns |
| t_{CL} | Clock LOW | 2.0 | | 2.0 | | 2.2 | | ns |
| Output Times | | | | | | | | |
| t_{CO} | Data Output Valid After CLK Rise | | 3.0 | | 3.0 | | 3.4 | ns |
| $t_{OE\bar{V}}$ | $\bar{O}E$ LOW to Output Valid | | 3.0 | | 3.0 | | 3.4 | ns |
| t_{DOH} | Data Output Hold After CLK Rise | 1.3 | | 1.3 | | 1.5 | | ns |
| t_{CHZ} | Clock to High-Z ^[16, 17, 18] | | 3.0 | | 3.0 | | 3.4 | ns |
| t_{CLZ} | Clock to Low-Z ^[16, 17, 18] | 1.3 | | 1.3 | | 1.5 | | ns |
| t_{EOHZ} | $\bar{O}E$ HIGH to Output High-Z ^[16, 17, 18] | | 3.0 | | 3.0 | | 3.4 | ns |
| t_{EOLZ} | $\bar{O}E$ LOW to Output Low-Z ^[16, 17, 18] | 0 | | 0 | | 0 | | ns |
| Setup Times | | | | | | | | |
| t_{AS} | Address Setup Before CLK Rise | 1.4 | | 1.4 | | 1.5 | | ns |
| t_{DS} | Data Input Setup Before CLK Rise | 1.4 | | 1.4 | | 1.5 | | ns |
| t_{CENS} | $\bar{C}EN$ Setup Before CLK Rise | 1.4 | | 1.4 | | 1.5 | | ns |
| t_{WES} | $\bar{W}E, \bar{B}W_x$ Setup Before CLK Rise | 1.4 | | 1.4 | | 1.5 | | ns |
| t_{ALS} | ADV/LD Setup Before CLK Rise | 1.4 | | 1.4 | | 1.5 | | ns |
| t_{CES} | Chip Select Setup | 1.4 | | 1.4 | | 1.5 | | ns |
| Hold Times | | | | | | | | |
| t_{AH} | Address Hold After CLK Rise | 0.4 | | 0.4 | | 0.5 | | ns |
| t_{DH} | Data Input Hold After CLK Rise | 0.4 | | 0.4 | | 0.5 | | ns |
| t_{CENH} | $\bar{C}EN$ Hold After CLK Rise | 0.4 | | 0.4 | | 0.5 | | ns |
| t_{WEH} | $\bar{W}E, \bar{B}W_x$ Hold After CLK Rise | 0.4 | | 0.4 | | 0.5 | | ns |
| t_{ALH} | ADV/LD Hold after CLK Rise | 0.4 | | 0.4 | | 0.5 | | ns |
| t_{CEH} | Chip Select Hold After CLK Rise | 0.4 | | 0.4 | | 0.5 | | ns |

Notes

15. This part has a voltage regulator internally; t_{Power} is the time power is supplied above V_{DD} minimum initially, before a read or write operation can be initiated.
16. t_{CHZ} , t_{CLZ} , t_{EOLZ} , and t_{EOHZ} are specified with AC test conditions shown in (b) of "AC Test Loads and Waveforms" on page 20. Transition is measured ± 200 mV from steady-state voltage.
17. At any supplied voltage and temperature, t_{EOHZ} is less than t_{EOLZ} and t_{CHZ} is less than t_{CLZ} to eliminate bus contention between SRAMs when sharing the same data bus. These specifications do not imply a bus contention condition, but reflect parameters guaranteed over worst case user conditions. Device is designed to achieve High-Z before Low-Z under the same system conditions.
18. This parameter is sampled and not 100% tested.

Switching Waveforms

Figure 6 shows read-write timing waveform.^[19, 20, 21]

Figure 6. Read/Write Timing

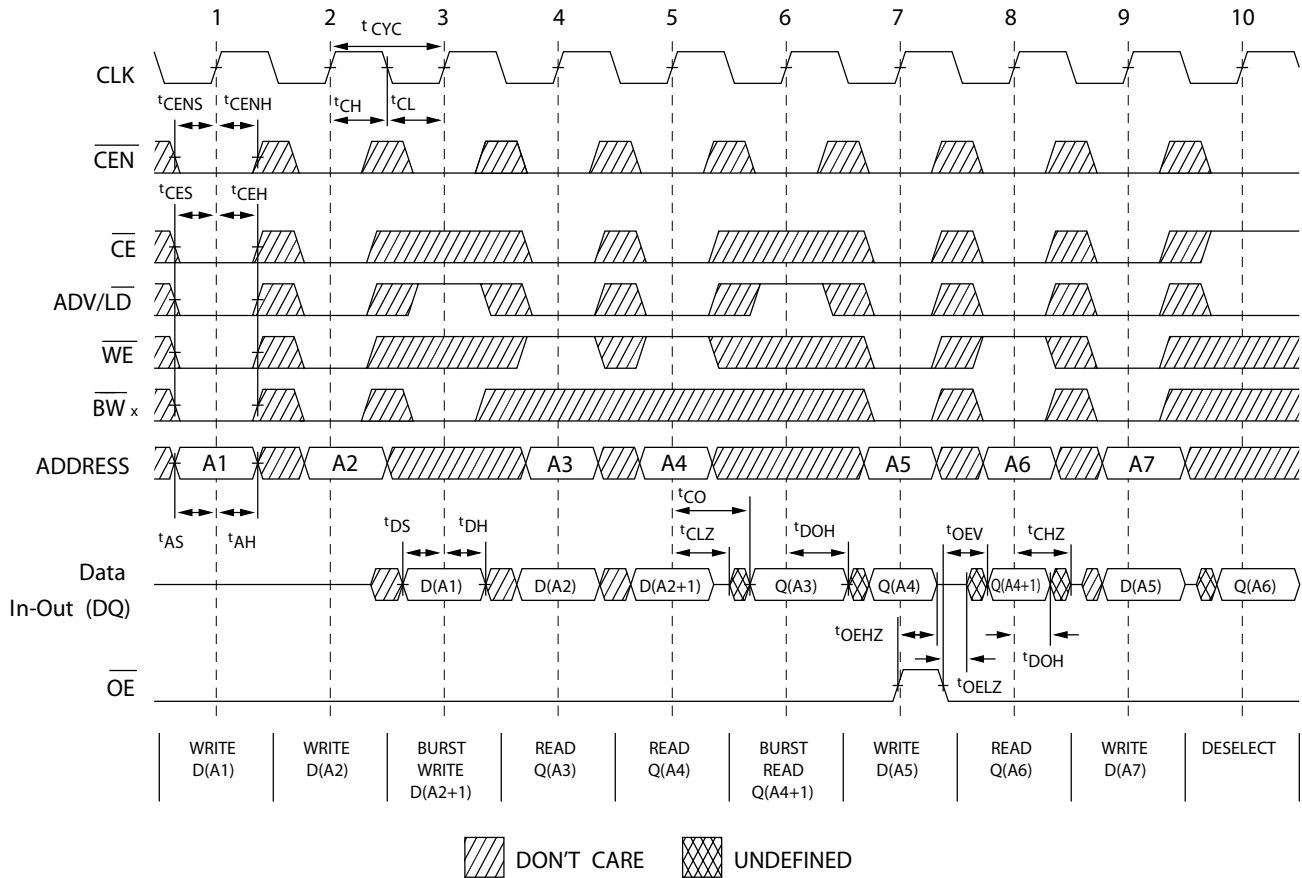

Notes

19. For this waveform ZZ is tied LOW.

20. When \overline{CE} is LOW, \overline{CE}_1 is LOW, \overline{CE}_2 is HIGH, and \overline{CE}_3 is LOW. When \overline{CE} is HIGH, \overline{CE}_1 is HIGH, \overline{CE}_2 is LOW, or \overline{CE}_3 is HIGH.

21. Order of the Burst sequence is determined by the status of the MODE (0 = Linear, 1 = Interleaved). Burst operations are optional.

Switching Waveforms (continued)

Figure 7 shows NOP, STALL and DESELECT Cycles waveform.^[19, 20, 22]

Figure 7. NOP, STALL and DESELECT Cycles

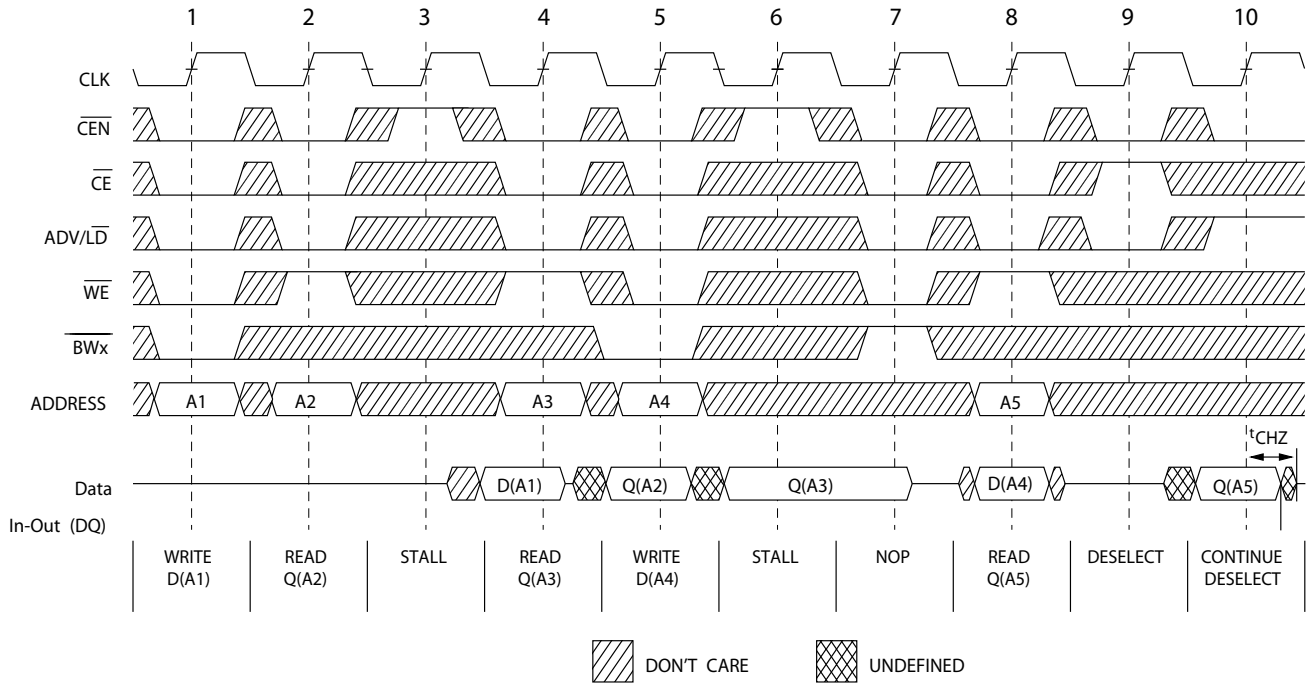
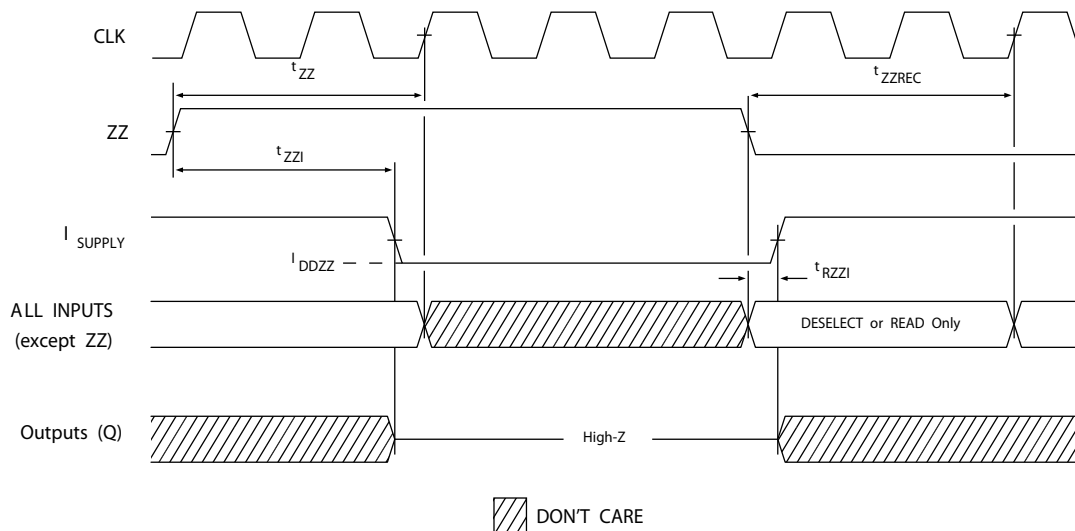

Figure 8 shows ZZ Mode timing waveform.^[23, 24]

Figure 8. ZZ Mode Timing



Notes

- 22. The IGNORE CLOCK EDGE or STALL cycle (Clock 3) illustrated \overline{CEN} being used to create a pause. A write is not performed during this cycle.
- 23. Device must be deselected when entering ZZ mode. See "Truth Table" on page 10 for all possible signal conditions to deselect the device.
- 24. IOs are in High-Z when exiting ZZ sleep mode.

Ordering Information

Not all of the speed, package and temperature ranges are available. Please contact your local sales representative or visit www.cypress.com for actual products offered.

| Speed (MHz) | Ordering Code | Package Diagram | Part and Package Type | Operating Range | |
|----------------------|----------------------|---|---|-----------------|------------|
| 167 | CY7C1470BV25-167AXC | 51-85050 | 100-pin Thin Quad Flat Pack (14 x 20 x 1.4 mm) Pb-Free | Commercial | |
| | CY7C1472BV25-167AXC | | | | |
| | CY7C1470BV25-167BZC | 51-85165 | 165-ball Fine-Pitch Ball Grid Array (15 x 17 x 1.4 mm) | | |
| | CY7C1472BV25-167BZC | | | | |
| | CY7C1470BV25-167BZXC | 51-85165 | 165-ball Fine-Pitch Ball Grid Array (15 x 17 x 1.4 mm) Pb-Free | | |
| | CY7C1472BV25-167BZXC | | | | |
| | CY7C1474BV25-167BGC | 51-85167 | 209-ball Fine-Pitch Ball Grid Array (14 x 22 x 1.76 mm) | | |
| | CY7C1474BV25-167BGXC | | 209-ball Fine-Pitch Ball Grid Array (14 x 22 x 1.76 mm) Pb-Free | | |
| | CY7C1470BV25-167AXI | 51-85050 | 100-pin Thin Quad Flat Pack (14 x 20 x 1.4 mm) Pb-Free | | Industrial |
| | CY7C1472BV25-167AXI | | | | |
| | CY7C1470BV25-167BZI | 51-85165 | 165-ball Fine-Pitch Ball Grid Array (15 x 17 x 1.4 mm) | | |
| | CY7C1472BV25-167BZI | | | | |
| | CY7C1470BV25-167BZXI | 51-85165 | 165-ball Fine-Pitch Ball Grid Array (15 x 17 x 1.4 mm) Pb-Free | | |
| | CY7C1472BV25-167BZXI | | | | |
| CY7C1474BV25-167BGI | 51-85167 | 209-ball Fine-Pitch Ball Grid Array (14 x 22 x 1.76 mm) | | | |
| CY7C1474BV25-167BGXI | | 209-ball Fine-Pitch Ball Grid Array (14 x 22 x 1.76 mm) Pb-Free | | | |
| 200 | CY7C1470BV25-200AXC | 51-85050 | 100-pin Thin Quad Flat Pack (14 x 20 x 1.4 mm) Pb-Free | Commercial | |
| | CY7C1472BV25-200AXC | | | | |
| | CY7C1470BV25-200BZC | 51-85165 | 165-ball Fine-Pitch Ball Grid Array (15 x 17 x 1.4 mm) | | |
| | CY7C1472BV25-200BZC | | | | |
| | CY7C1470BV25-200BZXC | 51-85165 | 165-ball Fine-Pitch Ball Grid Array (15 x 17 x 1.4 mm) Pb-Free | | |
| | CY7C1472BV25-200BZXC | | | | |
| | CY7C1474BV25-200BGC | 51-85167 | 209-ball Fine-Pitch Ball Grid Array (14 x 22 x 1.76 mm) | | |
| | CY7C1474BV25-200BGXC | | 209-ball Fine-Pitch Ball Grid Array (14 x 22 x 1.76 mm) Pb-Free | | |
| | CY7C1470BV25-200AXI | 51-85050 | 100-pin Thin Quad Flat Pack (14 x 20 x 1.4 mm) Pb-Free | | Industrial |
| | CY7C1472BV25-200AXI | | | | |
| | CY7C1470BV25-200BZI | 51-85165 | 165-ball Fine-Pitch Ball Grid Array (15 x 17 x 1.4 mm) | | |
| | CY7C1472BV25-200BZI | | | | |
| | CY7C1470BV25-200BZXI | 51-85165 | 165-ball Fine-Pitch Ball Grid Array (15 x 17 x 1.4 mm) Pb-Free | | |
| | CY7C1472BV25-200BZXI | | | | |
| CY7C1474BV25-200BGI | 51-85167 | 209-ball Fine-Pitch Ball Grid Array (14 x 22 x 1.76 mm) | | | |
| CY7C1474BV25-200BGXI | | 209-ball Fine-Pitch Ball Grid Array (14 x 22 x 1.76 mm) Pb-Free | | | |

Ordering Information (continued)

Not all of the speed, package and temperature ranges are available. Please contact your local sales representative or visit www.cypress.com for actual products offered.

| Speed (MHz) | Ordering Code | Package Diagram | Part and Package Type | Operating Range |
|----------------------|----------------------|---|---|-----------------|
| 250 | CY7C1470BV25-250AXC | 51-85050 | 100-pin Thin Quad Flat Pack (14 x 20 x 1.4 mm) Pb-Free | Commercial |
| | CY7C1472BV25-250AXC | | | |
| | CY7C1470BV25-250BZC | 51-85165 | 165-ball Fine-Pitch Ball Grid Array (15 x 17 x 1.4 mm) | |
| | CY7C1472BV25-250BZC | | | |
| | CY7C1470BV25-250BZXC | 51-85165 | 165-ball Fine-Pitch Ball Grid Array (15 x 17 x 1.4 mm) Pb-Free | |
| | CY7C1472BV25-250BZXC | | | |
| | CY7C1474BV25-250BGC | 51-85167 | 209-ball Fine-Pitch Ball Grid Array (14 x 22 x 1.76 mm) | |
| | CY7C1474BV25-250BGXC | | 209-ball Fine-Pitch Ball Grid Array (14 x 22 x 1.76 mm) Pb-Free | |
| | CY7C1470BV25-250AXI | 51-85050 | 100-Pin Thin Quad Flat Pack (14 x 20 x 1.4 mm) Pb-Free | Industrial |
| | CY7C1472BV25-250AXI | | | |
| | CY7C1470BV25-250BZI | 51-85165 | 165-ball Fine-Pitch Ball Grid Array (15 x 17 x 1.4 mm) | |
| | CY7C1472BV25-250BZI | | | |
| | CY7C1470BV25-250BZXI | 51-85165 | 165-ball Fine-Pitch Ball Grid Array (15 x 17 x 1.4 mm) Pb-Free | |
| | CY7C1472BV25-250BZXI | | | |
| CY7C1474BV25-250BGI | 51-85167 | 209-ball Fine-Pitch Ball Grid Array (14 x 22 x 1.76 mm) | | |
| CY7C1474BV25-250BGXI | | 209-ball Fine-Pitch Ball Grid Array (14 x 22 x 1.76 mm) Pb-Free | | |

Package Diagrams (continued)

Figure 10. 165-Ball FBGA (15 x 17 x 1.4 mm), 51-85165

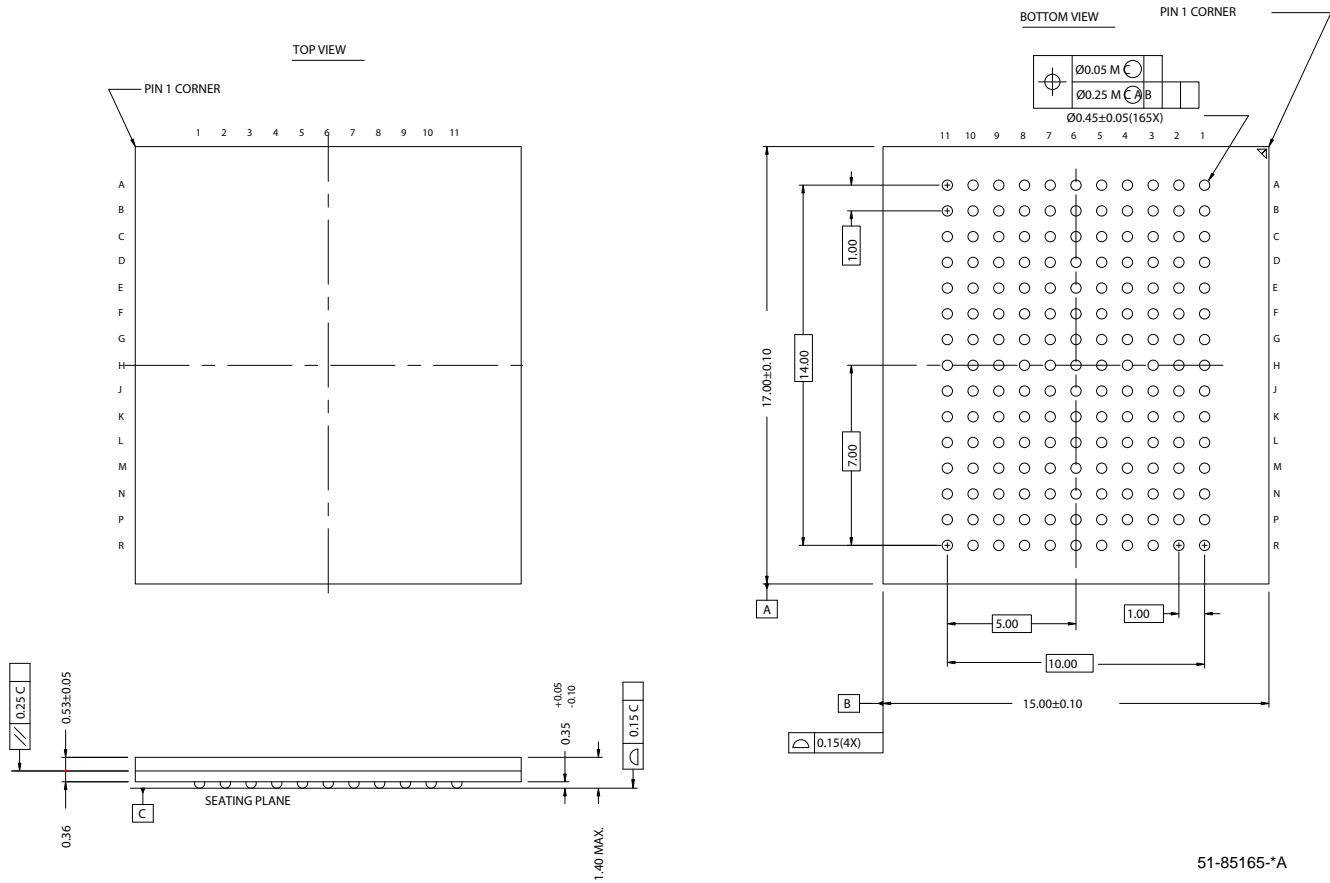

51-85165-A

Package Diagrams (continued)

Figure 11. 209-Ball FBGA (14 x 22 x 1.76 mm), 51-85167

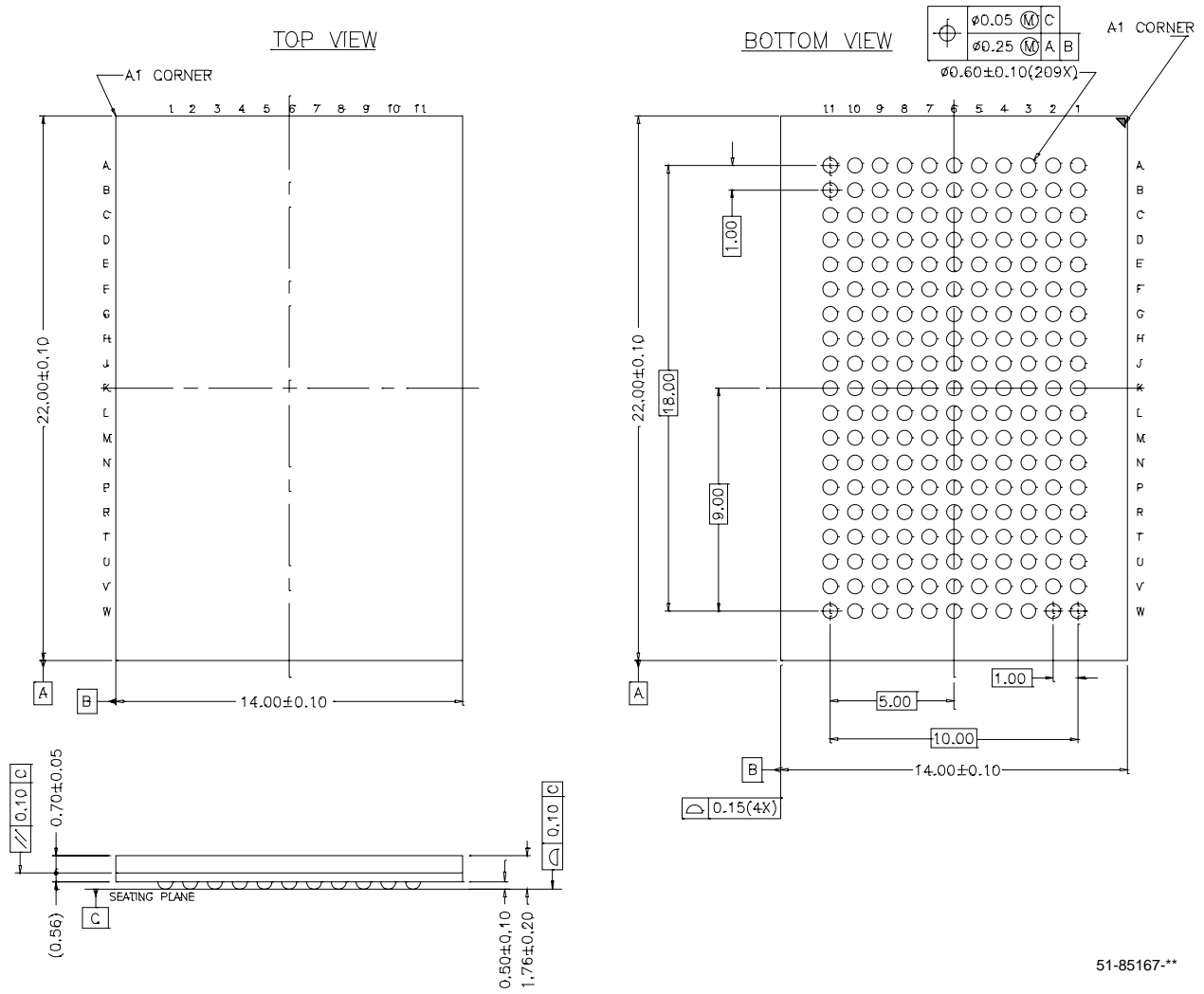

51-85167-**

Document History Page

| Document Title: CY7C1470BV25/CY7C1472BV25/CY7C1474BV25, 72-Mbit (2M x 36/4M x 18/1M x 72) Pipelined SRAM with NoBL™ Architecture | | | | |
|--|---------|------------|-----------------|--|
| Document Number: 001-15032 | | | | |
| REV. | ECN No. | Issue Date | Orig. of Change | Description of Change |
| ** | 1032642 | See ECN | VKN/KKVTMP | New data sheet |
| *A | 1562503 | See ECN | VKN/AESA | Removed 1.8V IO offering from the data sheet |
| *B | 1897447 | See ECN | VKN/AESA | Added footnote 14 related to IDD |
| *C | 2082487 | See ECN | VKN | Converted from preliminary to final |
| *D | 2159486 | See ECN | VKN/PYRS | Minor Change-Moved to the external web |

© Cypress Semiconductor Corporation, 2007-2008. The information contained herein is subject to change without notice. Cypress Semiconductor Corporation assumes no responsibility for the use of any circuitry other than circuitry embodied in a Cypress product. Nor does it convey or imply any license under patent or other rights. Cypress products are not warranted nor intended to be used for medical, life support, life saving, critical control or safety applications, unless pursuant to an express written agreement with Cypress. Furthermore, Cypress does not authorize its products for use as critical components in life-support systems where a malfunction or failure may reasonably be expected to result in significant injury to the user. The inclusion of Cypress products in life-support systems application implies that the manufacturer assumes all risk of such use and in doing so indemnifies Cypress against all charges.

Any Source Code (software and/or firmware) is owned by Cypress Semiconductor Corporation (Cypress) and is protected by and subject to worldwide patent protection (United States and foreign), United States copyright laws and international treaty provisions. Cypress hereby grants to licensee a personal, non-exclusive, non-transferable license to copy, use, modify, create derivative works of, and compile the Cypress Source Code and derivative works for the sole purpose of creating custom software and/or firmware in support of licensee product to be used only in conjunction with a Cypress integrated circuit as specified in the applicable agreement. Any reproduction, modification, translation, compilation, or representation of this Source Code except as specified above is prohibited without the express written permission of Cypress.

Disclaimer: CYPRESS MAKES NO WARRANTY OF ANY KIND, EXPRESS OR IMPLIED, WITH REGARD TO THIS MATERIAL, INCLUDING, BUT NOT LIMITED TO, THE IMPLIED WARRANTIES OF MERCHANTABILITY AND FITNESS FOR A PARTICULAR PURPOSE. Cypress reserves the right to make changes without further notice to the materials described herein. Cypress does not assume any liability arising out of the application or use of any product or circuit described herein. Cypress does not authorize its products for use as critical components in life-support systems where a malfunction or failure may reasonably be expected to result in significant injury to the user. The inclusion of Cypress' product in a life-support systems application implies that the manufacturer assumes all risk of such use and in doing so indemnifies Cypress against all charges.

Use may be limited by and subject to the applicable Cypress software license agreement.