

Aluminum Capacitors SMD (Chip), Very Low Z

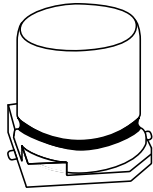
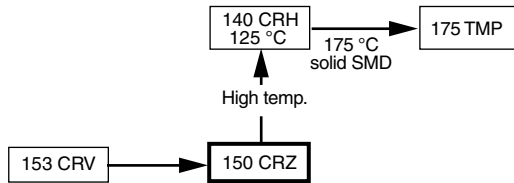


Fig.1 Component outline



FEATURES

- Polarized aluminum electrolytic capacitors, non-solid electrolyte, self healing
- SMD-version with base plate, lead (Pb)-free reflow solderable
- Very low impedance, very high ripple current
- Very long useful life: 5000 hours at 105 °C for case size $\geq 12.5 \times 12.5 \times 13$
- Standard 4 pin-version for diameter ≥ 12.5 mm
- 4 pin-version for diameter 10 mm on request
- Charge and discharge proof, no peak current limitation
- Lead (Pb)-free and RoHS compliant
- ATTENTION: for maximum safe soldering conditions refer to Fig. 4



RoHS
COMPLIANT

APPLICATIONS

- SMD technology, for high mounting density
- Industrial and professional applications
- Automotive, general industrial
- Smoothing, filtering, buffering
- 4 pin-version for high vibration

MARKING

- Rated capacitance (in μF)
- Rated voltage (in V)
- Date code, in accordance with IEC 60062
- Black mark or ‘-’ sign indicating the cathode (the anode is identified by bevelled edges)
- Code indicating group number (Z)

PACKAGING

Supplied in blister tape on reel

QUICK REFERENCE DATA	
DESCRIPTION	VALUE
Nominal case sizes (L x W x H in mm)	8 x 8 x 10 to 12.5 x 12.5 x 16
Rated capacitance range, C_R	33 to 2200 μF
Tolerance on C_R	$\pm 20\%$
Rated voltage range, U_R	6.3 to 63 V
Category temperature range	- 55 to + 105 °C
Endurance test at 105 °C: case size $\leq 10 \times 10 \times 14$ case size $\geq 12.5 \times 12.5 \times 13$	2000 hours 3000 hours
Useful life at 105 °C: case size $\leq 10 \times 10 \times 10$ case size $10 \times 10 \times 14$ case size $\geq 12.5 \times 12.5 \times 13$	2500 hours 3000 hours 5000 hours
Useful life at 40 °C; 1.8 x I_R applied: case size $\leq 10 \times 10 \times 10$ case size $10 \times 10 \times 14$ case size $\geq 12.5 \times 12.5 \times 13$	125 000 hours 150 000 hours 250 000 hours
Shelf life at 0 V, 105 °C	1000 hours
Based on sectional specification	IEC 60384-18/CECC32300
Climatic category IEC 60068	55/105/56

SELECTION CHART FOR C_R , U_R AND RELEVANT NOMINAL CASE SIZES (L x W x H in mm)							
C_R (μF)	U_R (V)						
	6.3	10	16	25	35	50	63
33	-	-	-	-	-	-	8 x 8 x 10
47	-	-	-	-	-	-	8 x 8 x 10
	-	-	-	-	-	-	10 x 10 x 10
68	-	-	-	-	-	8 x 8 x 10	10 x 10 x 10
100	-	-	-	-	8 x 8 x 10	10 x 10 x 10	10 x 10 x 14
150	-	-	-	8 x 8 x 10	-	-	12.5 x 12.5 x 13
220	-	-	8 x 8 x 10	8 x 8 x 10	10 x 10 x 10	10 x 10 x 14	12.5 x 12.5 x 16
330	-	8 x 8 x 10	8 x 8 x 10	10 x 10 x 10	10 x 10 x 14	12.5 x 12.5 x 13	-
470	8 x 8 x 10	8 x 8 x 10	10 x 10 x 10	10 x 10 x 14	12.5 x 12.5 x 13	-	-
680	-	10 x 10 x 10	10 x 10 x 14	12.5 x 12.5 x 13	12.5 x 12.5 x 16	-	-
1000	10 x 10 x 10	10 x 10 x 14	12.5 x 12.5 x 13	12.5 x 12.5 x 16	-	-	-
1500	-	12.5 x 12.5 x 13	12.5 x 12.5 x 16	-	-	-	-
2200	12.5 x 12.5 x 13	12.5 x 12.5 x 16	-	-	-	-	-

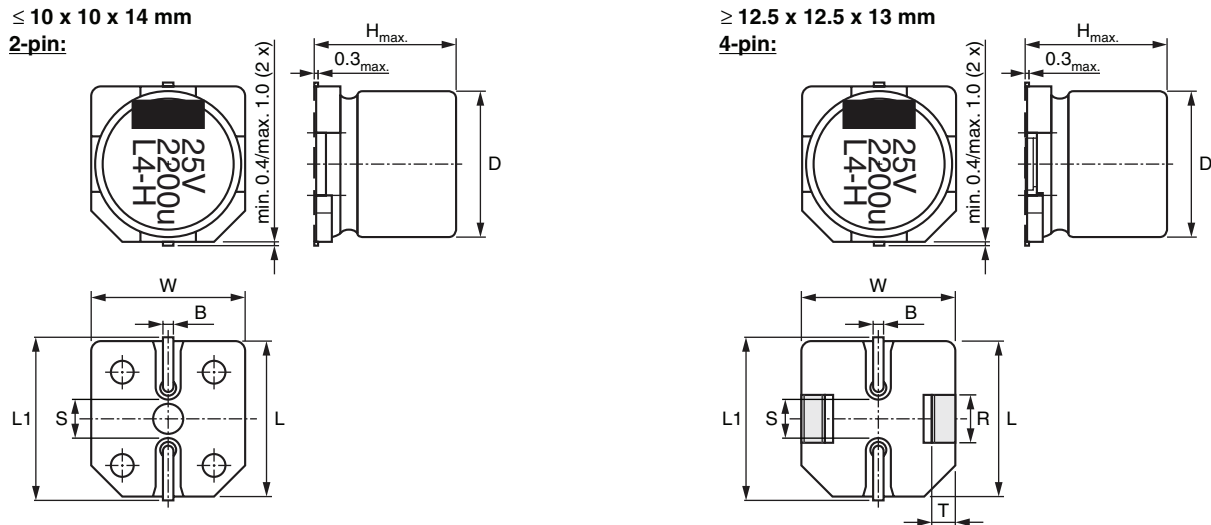


Fig.2 Dimensional Outline

Table 1

DIMENSIONS in millimeters AND MASS												
NOMINAL CASE SIZE L x W x H	CASE CODE	L _{max.}	W _{max.}	H _{max.}	Ø D	B _{max.}	S	L1 _{max.}	R ± 0.1	T ± 0.1	MASS (g)	
8 x 8 x 10	0810	8.5	8.5	10.5	8.0	1.0	2.2	9.9	-	-	≈ 1.0	
10 x 10 x 10	1010	10.5	10.5	10.5	10.0	1.0	3.5	11.8	-	-	≈ 1.3	
10 x 10 x 14	1014	10.5	10.5	14.3	10.0	1.0	3.5	11.8	-	-	≈ 1.5	
12.5 x 12.5 x 13	1213	12.8	12.8	14.0	12.5	1.3	3.6	14.9	3.7	2.4	≈ 2.6	
12.5 x 12.5 x 16	1216	12.8	12.8	16.5	12.5	1.3	3.6	14.9	3.7	2.4	≈ 2.8	

Table 2

TAPE AND REEL DIMENSIONS in millimeters, PACKAGING QUANTITIES						
NOMINAL CASE SIZE L x W x H	CASE CODE	PITCH P ₁	TAPE WIDTH W	TAPE THICKNESS T ₂	REEL DIAMETER	PACKAGING QUANTITY PER REEL
8 x 8 x 10	0810	16	24	11.3	380	500
10 x 10 x 10	1010	16	24	11.3	380	500
10 x 10 x 14	1014	16	24	14.8	330	250
12.5 x 12.5 x 13	1213	20	24	15.5	380	250
12.5 x 12.5 x 16	1216	24	32	17.5	380	200

Note

Detailed tape dimensions see section 'PACKAGING'.

MOUNTING

The capacitors are designed for automatic placement on to printed-circuit boards.

Optimum dimensions of soldering pads depend amongst others on soldering method, mounting accuracy, print layout and/or adjacent components.

For recommended soldering pad dimensions, refer to Fig.3 and Table 3.

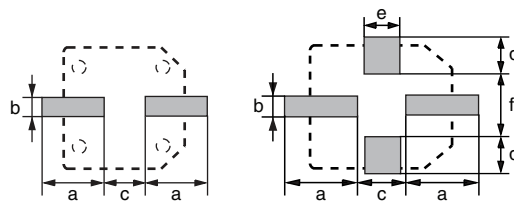
SOLDERING

Soldering conditions are defined by the curve, temperature versus time, where the temperature is that measured on the component during processing.

For maximum conditions refer to Fig.4.

Any temperature versus time curve which does not exceed the specified maximum curves may be applied.

 AS A GENERAL PRINCIPLE, TEMPERATURE AND DURATION SHALL BE THE **MINIMUM** NECESSARY REQUIRED TO ENSURE GOOD SOLDERING CONNECTIONS. HOWEVER, THE SPECIFIED MAXIMUM CURVES SHOULD NEVER BE EXCEEDED.



Case size $\varnothing D \leq 10$ mm Case size $\varnothing D \geq 12.5$ mm
Fig.3 Recommended soldering pad dimensions

Table 3

RECOMMENDED SOLDERING PAD DIMENSIONS in millimeters						
CASE CODE	a	b	c	d	e	f
0810	3.5	2.5	3.0	-	-	-
1010	4.3	2.5	4.0	-	-	-
1014	4.3	2.5	4.0	-	-	-
1213	5.5	2.5	4.0	4.2	5.0	5.6
1216	5.5	2.5	4.0	4.2	5.0	5.6

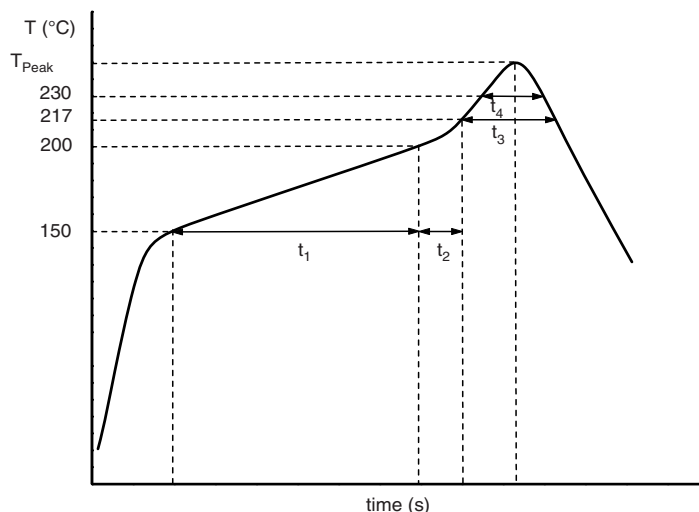


Fig.4 Maximum temperature load during reflow soldering

Table 4

REFLOW SOLDERING CONDITIONS		
PROFILE FEATURES	CASE CODE 0810 to 1014	CASE CODE 1213 to 1216
Max. time from 25 °C to T_{peak}	240 s	200 s
Max. ramp-up rate to 150 °C	3 K/s	3 K/s
Max. time from 150 °C to 200 °C, (t_1)	150 s	120 s
Ramp up rate from 200 °C to T_{peak}	0.5 K/s to 3 K/s	0.5 K/s to 3 K/s
Max. time from 200 °C - 217 °C, (t_2)	60 s	60 s
Max. time above $T_{Liquidus}$ (217 °C) (t_3)	90 s	60 s
Max. time above 230 °C (t_4)	40 s	30 s
Peak temperature T_{peak}	250 °C	240 °C
Max. time above T_{peak} minus 5 °C	5 s	10 s
Max. ramp-down rate from $T_{Liquidus}$	6 K/s	6 K/s

Note

Temperature measuring point on top of the case and terminals max. 2 runs with pause of min. 30 minutes in between



ELECTRICAL DATA	
SYMBOL	DESCRIPTION
C_R	rated capacitance at 100 Hz, tolerance $\pm 20\%$
I_R	rated RMS ripple current at 100 kHz, 105 °C
I_{L2}	max. leakage current after 2 minutes at U_R
$\tan \delta$	max. dissipation factor at 100 Hz
Z	max. impedance at 100 kHz

ORDERING EXAMPLE

Electrolytic capacitor 150 CRZ series

220 μ F/50 V; $\pm 20\%$

Nominal case size: 10 x 10 x 14 mm; taped on reel

Ordering Code: MAL215097102E3

Former 12 NC: 2222 150 97102

Note

Unless otherwise specified, all electrical values in Table 5 apply at $T_{amb} = 20\text{ °C}$, $P = 86$ to 106 kPa, $RH = 45$ to 75 %

Table 5

ELECTRICAL DATA AND ORDERING INFORMATION								
U_R (V)	C_R (μ F)	NOMINAL CASE SIZE L x W x H (mm)	I_R 105 °C 100 kHz (mA)	I_{L2} 2 min (μ A)	$\tan \delta$ 100 Hz	Z 100 kHz 20 °C (Ω)	Z 100 kHz - 40 °C (Ω)	ORDERING CODE MAL2150.....
6.3	470	8 x 8 x 10	435	30	0.24	0.250	2.000	97311E3
	1000	10 x 10 x 10	670	63	0.24	0.130	1.100	97301E3
	2200	12.5 x 12.5 x 13	905	139	0.26	0.077	0.600	97312E3
10	330	8 x 8 x 10	435	33	0.20	0.250	2.000	97411E3
	470	8 x 8 x 10	435	47	0.20	0.250	2.000	97412E3
	680	10 x 10 x 10	670	68	0.20	0.130	1.100	97401E3
	1000	10 x 10 x 14	850	100	0.20	0.100	0.800	97402E3
	1500	12.5 x 12.5 x 13	905	150	0.22	0.077	0.600	97413E3
	2200	12.5 x 12.5 x 16	1007	220	0.22	0.060	0.480	97414E3
16	220	8 x 8 x 10	435	35	0.16	0.250	2.000	97511E3
	330	8 x 8 x 10	435	53	0.16	0.250	2.000	97512E3
	470	10 x 10 x 10	670	75	0.16	0.130	1.100	97501E3
	680	10 x 10 x 14	850	109	0.16	0.100	0.800	97502E3
	1000	12.5 x 12.5 x 13	905	160	0.18	0.077	0.600	97513E3
	1500	12.5 x 12.5 x 16	1007	240	0.18	0.060	0.480	97514E3
25	150	8 x 8 x 10	420	38	0.14	0.280	2.240	97611E3
	220	8 x 8 x 10	420	55	0.14	0.280	2.240	97612E3
	330	10 x 10 x 10	640	83	0.14	0.140	1.120	97601E3
	470	10 x 10 x 14	820	118	0.14	0.110	0.880	97602E3
	680	12.5 x 12.5 x 13	905	170	0.16	0.077	0.600	97613E3
	1000	12.5 x 12.5 x 16	1007	250	0.16	0.060	0.480	97614E3
35	100	8 x 8 x 10	405	35	0.12	0.300	2.400	97011E3
	220	10 x 10 x 10	630	77	0.12	0.150	1.200	97001E3
	330	10 x 10 x 14	790	116	0.12	0.120	0.960	97002E3
	470	12.5 x 12.5 x 13	905	165	0.14	0.077	0.600	97012E3
	680	12.5 x 12.5 x 16	1007	238	0.14	0.060	0.480	97013E3
50	68	8 x 8 x 10	333	34	0.12	0.480	3.840	97111E3
	100	10 x 10 x 10	490	50	0.12	0.240	1.920	97101E3
	220	10 x 10 x 14	620	110	0.12	0.190	1.520	97102E3
	330	12.5 x 12.5 x 13	690	165	0.12	0.130	1.040	97112E3
63	33	8 x 8 x 10	270	21	0.10	0.650	5.200	97812E3
	47	8 x 8 x 10	270	30	0.10	0.650	5.200	97811E3
	47	10 x 10 x 10	390	30	0.10	0.380	3.000	97801E3
	68	10 x 10 x 10	390	43	0.10	0.380	3.000	97802E3
	100	10 x 10 x 14	507	63	0.10	0.290	2.320	97803E3
	150	12.5 x 12.5 x 13	507	97	0.10	0.250	2.000	97821E3
	220	12.5 x 12.5 x 16	637	141	0.10	0.200	1.600	97815E3



ADDITIONAL ELECTRICAL DATA		
PARAMETER	CONDITIONS	VALUE
Voltage		
Surge voltage for short periods	IEC 60384-18, subclause 4.14	$U_s \leq 1.15 \times U_R$
Reverse voltage for short periods	IEC 60384-18, subclause 4.16	$U_{rev} \leq 1 \text{ V}$
Current		
Leakage current	After 2 minutes at U_R	$I_{L2} \leq 0.01 \times C_R \times U_R$
Inductance		
Equivalent series inductance (ESL)	$\varnothing D = 8 \text{ mm}$	typ. 6 nH
	$\varnothing D = 10 \text{ mm}$	typ. 8 nH
	$\varnothing D \geq 12.5 \text{ mm}$	typ. 11 nH
Resistance		
Equivalent series resistance (ESR) at 100 Hz	Calculated from $\tan \delta_{max}$ and C_R (see Table 5)	$ESR = \tan \delta / 2 \pi f C_R$

CAPACITANCE

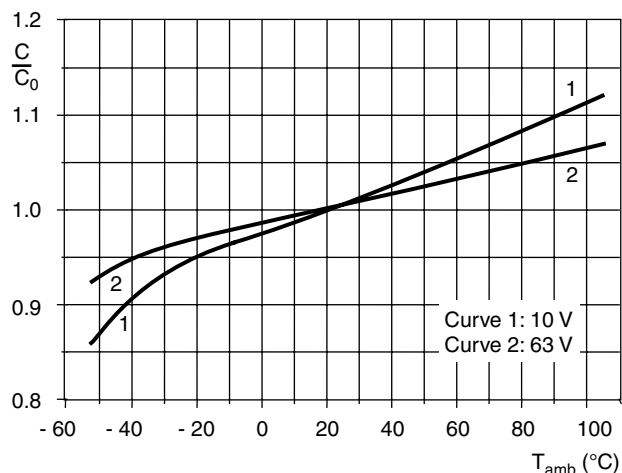


Fig.5 Typical multiplier of capacitance C as a function of temperature at 100 Hz
 C_0 = typical capacitance C at 20 °C, 100 Hz

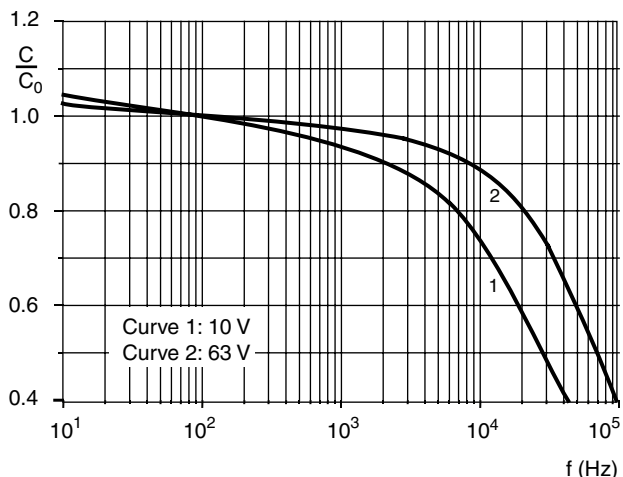


Fig.6 Typical multiplier of capacitance as a function of frequency at 20 °C
 C_0 = typical capacitance at 20 °C, 100 Hz

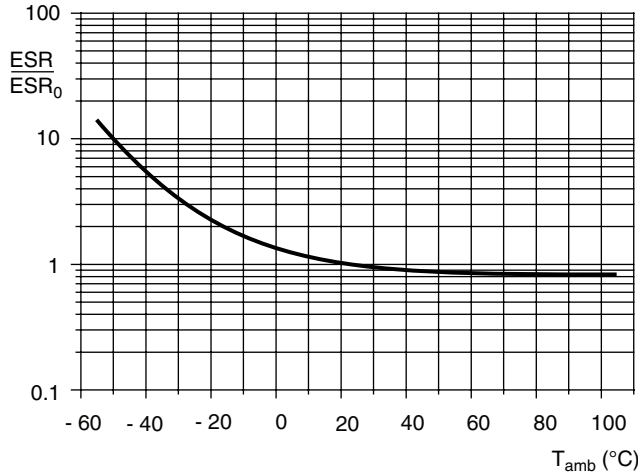
EQUIVALENT SERIES RESISTANCE (ESR)


Fig.7 Typical multiplier of ESR as a function of temperature at 100 Hz
 ESR_0 = typical ESR at 20 °C, 100 Hz

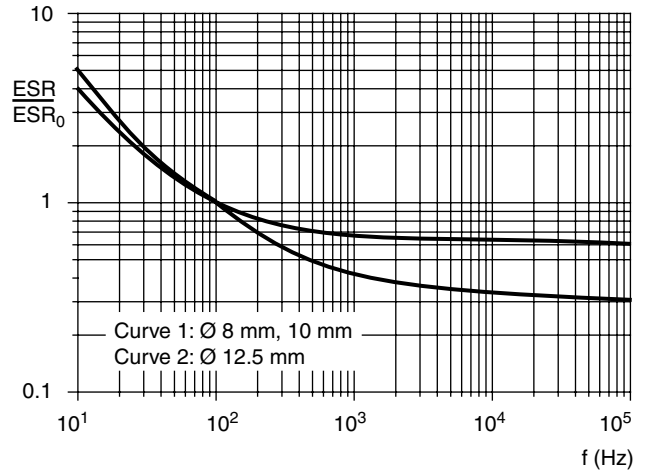


Fig.8 Typical multiplier ESR as a function of frequency at 20 °C
 ESR_0 = typical ESR at 20 °C, 100 Hz

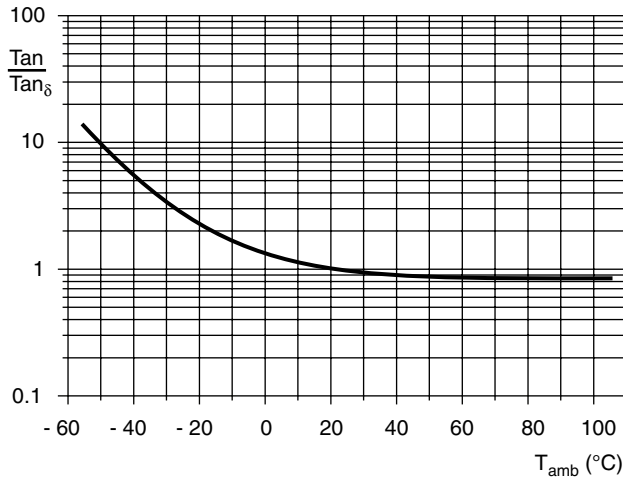
DISSIPATION FACTOR ($\tan \delta$)


Fig.9 Typical multiplier of dissipation factor $\tan \delta$ as a function of temperature at °C 20 at 100 Hz
 $\tan \delta_0$ = typical $\tan \delta$ at 20 °C, 100 Hz

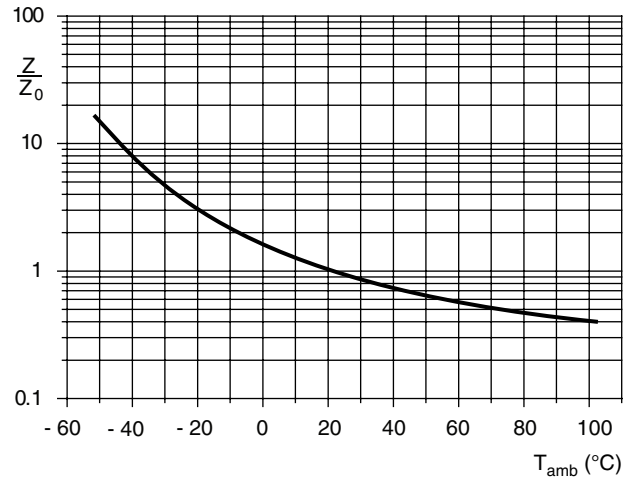
IMPEDANCE (Z)


Fig.10 Typical multiplier of impedance Z as a function of temperature at 100 kHz
 Z_0 = typical impedance Z at 20 °C, 100 kHz

IMPEDANCE (Z)

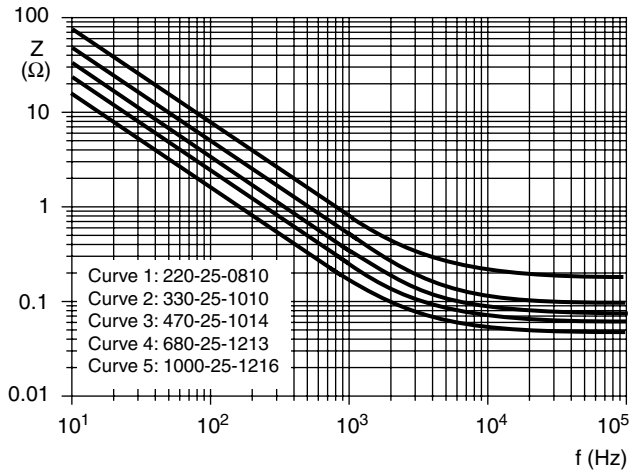


Fig.11 Typical impedance Z as a function of frequency at 20 °C

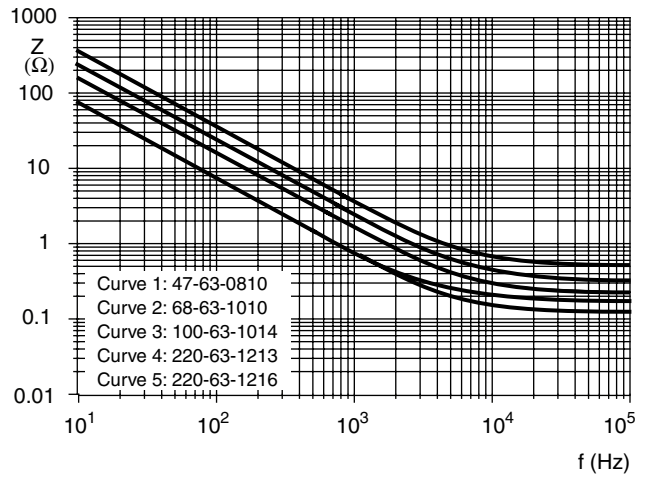
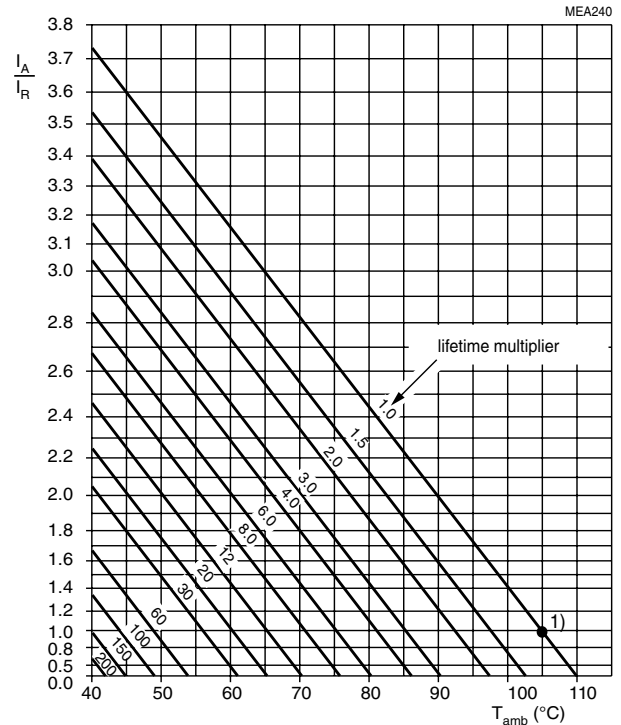


Fig.12 Typical impedance Z as a function of frequency at 20 °C

RIPPLE CURRENT AND USEFUL LIFE



I_A = actual ripple current at 100 Hz
 I_R = rated ripple current at 100 Hz, 105 °C
 (1) = useful life at 105 °C and I_R applied: 2000 h

Fig.13 Multiplier of useful life as a function of ambient temperature and ripple current load

Table 6

MULTIPLIER OF RIPPLE CURRENT (I_R) AS A FUNCTION OF FREQUENCY			
FREQUENCY (Hz)	I_R MULTIPLIER		
	$U_R = 6.3$ to 25 V	$U_R = 35$ V	$U_R = 50$ to 63 V
100	0.70	0.65	0.60
300	0.80	0.80	0.75
1000	0.85	0.85	0.85
3000	0.93	0.93	0.93
10 000	0.95	0.95	0.95
30 000	0.97	0.97	0.97
100 000	1.00	1.00	1.00

Table 7

TEST PROCEDURES AND REQUIREMENTS			
TEST		PROCEDURE (quick reference)	REQUIREMENTS
NAME OF TEST	REFERENCE		
Mounting	IEC 60384-18, subclause 4.3	shall be performed prior to tests mentioned below; reflow soldering; for maximum temperature load refer to chapter "Mounting"	$\Delta C/C: \pm 5\%$ $\tan \delta \leq \text{spec. limit}$ $I_{L2} \leq \text{spec. limit}$
Endurance	IEC 60384-18/ CECC32300, subclause 4.15	$T_{\text{amb}} = 105\text{ }^\circ\text{C}$; U_R applied; case size $\leq 10 \times 10 \times 14$: 2000 hours case size $\geq 12.5 \times 12.5 \times 13$: 3000 hours	$U_R = 6.3$ V; $\Delta C/C: \pm 25\%$ $U_R \geq 10$ V; $\Delta C/C: \pm 20\%$ $\tan \delta \leq 2 \times \text{spec. limit}$ $I_{L2} \leq \text{spec. limit}$
Useful life	CECC 30301, subclause 1.8.1	$T_{\text{amb}} = 105\text{ }^\circ\text{C}$; U_R and I_R applied; case size $\leq 10 \times 10 \times 10$: 2500 hours case size = $10 \times 10 \times 14$: 3000 hours case size $\geq 12.5 \times 12.5 \times 13$: 5000 hours	$\Delta C/C: \pm 30\%$ $\tan \delta \leq 3 \times \text{spec. limit}$ $I_{L2} \leq \text{spec. limit}$ no short or open circuit total failure percentage: $\leq 1\%$
Shelf life (storage at high temperature)	IEC 60384-18/ CECC32300, subclause 4.17	$T_{\text{amb}} = 105\text{ }^\circ\text{C}$; no voltage applied; 1000 hours after test: U_R to be applied for 30 minutes, 24 to 48 hours before measurement	for requirements see 'Endurance test' above



Disclaimer

All product specifications and data are subject to change without notice.

Vishay Intertechnology, Inc., its affiliates, agents, and employees, and all persons acting on its or their behalf (collectively, "Vishay"), disclaim any and all liability for any errors, inaccuracies or incompleteness contained herein or in any other disclosure relating to any product.

Vishay disclaims any and all liability arising out of the use or application of any product described herein or of any information provided herein to the maximum extent permitted by law. The product specifications do not expand or otherwise modify Vishay's terms and conditions of purchase, including but not limited to the warranty expressed therein, which apply to these products.

No license, express or implied, by estoppel or otherwise, to any intellectual property rights is granted by this document or by any conduct of Vishay.

The products shown herein are not designed for use in medical, life-saving, or life-sustaining applications unless otherwise expressly indicated. Customers using or selling Vishay products not expressly indicated for use in such applications do so entirely at their own risk and agree to fully indemnify Vishay for any damages arising or resulting from such use or sale. Please contact authorized Vishay personnel to obtain written terms and conditions regarding products designed for such applications.

Product names and markings noted herein may be trademarks of their respective owners.