

## Features

- Low Forward Voltage Drop
- Excellent High Temperature Stability
- Patented Super Barrier Rectifier Technology
- Soft, Fast Switching Capability
- **Lead Free Finish, RoHS Compliant (Note 2)**

## Mechanical Data

- Case: TO-220AB, ITO-220AB
- Case Material: Molded Plastic, UL Flammability Classification Rating 94V-0
- Moisture Sensitivity: Level 1 per J-STD-020D
- Terminals: Matte Tin Finish annealed over Copper leadframe. Solderable per MIL-STD-202, Method 208 <sup>(E3)</sup>
- Marking Information: See Page 2
- Ordering Information: See Page 2
- Weight: TO-220AB – 2.1 grams (approximate)  
ITO-220AB – 1.9 grams (approximate)



TO-220AB



ITO-220AB

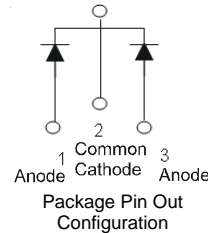

## Maximum Ratings @<sub>T<sub>A</sub></sub> = 25°C unless otherwise specified

Single phase, half wave, 60Hz, resistive or inductive load.  
For capacitance load, derate current by 20%.

Characteristic	Symbol	Value	Unit
Peak Repetitive Reverse Voltage	$V_{RRM}$	200	V
Working Peak Reverse Voltage	$V_{RWM}$		
DC Blocking Voltage	$V_{RM}$		
RMS Reverse Voltage	$V_{R(RMS)}$	141	V
Average Rectified Output Current @ $T_C = 150^\circ\text{C}$	$I_O$	30	A
Non-Repetitive Peak Forward Surge Current 8.3ms	$I_{FSM}$	200	A
Single Half Sine-Wave Superimposed on Rated Load			
Peak Repetitive Reverse Surge Current (2µs-1KHz)	$I_{RRM}$	2	A

## Thermal Characteristics

Characteristic	Symbol	Value	Unit
Maximum Thermal Resistance (per leg)	$R_{\theta JC}$	2	°C/W
Package = TO-220AB			
Package = ITO-220AB		4	
Operating and Storage Temperature Range	$T_J, T_{STG}$	-65 to +175	°C

## Electrical Characteristics @<sub>T<sub>A</sub></sub> = 25°C unless otherwise specified

Characteristic	Symbol	Min	Typ	Max	Unit	Test Condition
Reverse Breakdown Voltage (Note 1)	$V_{(BR)R}$	200	-	-	V	$I_R = 0.1\text{mA}$
Forward Voltage Drop	$V_F$	-	0.72	0.98 0.88	V	$I_F = 15\text{A}, T_J = 25^\circ\text{C}$ $I_F = 15\text{A}, T_J = 125^\circ\text{C}$
Leakage Current (Note 1)	$I_R$	-	-	0.1 10	mA	$V_R = 200\text{V}, T_J = 25^\circ\text{C}$ $V_R = 200\text{V}, T_J = 125^\circ\text{C}$
Reverse Recovery Time	$t_{rr}$	-	24	30	ns	$I_F = 0.5\text{A}, I_R = 1\text{A}, I_{RR} = 0.25\text{A}$
		-	20	25		$I_F = 1\text{A}, V_R = 30\text{V}, di/dt = 100\text{A}/\mu\text{s}, T_J = 25^\circ\text{C}$

Notes: 1. Short duration pulse test used to minimize self-heating effect.  
2. RoHS revision 13.2.2003. High temperature solder exemption applied, see *EU Directive Annex Note 7*.

SBR is a registered trademark of Diodes Incorporated.

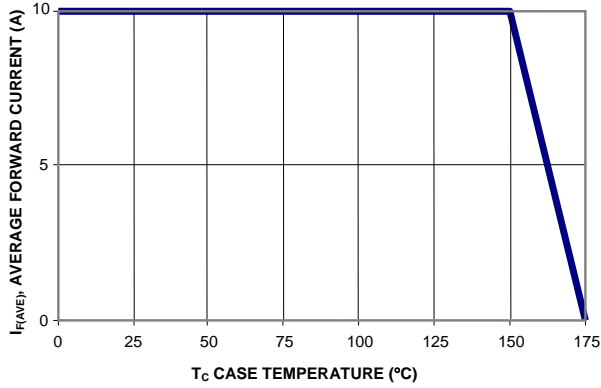

Figure 1: Current Derating Curve, Per Element

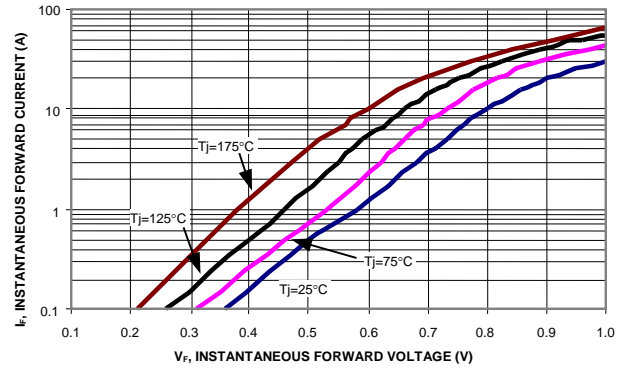

Figure 2: Typical Forward Characteristics, Per Element

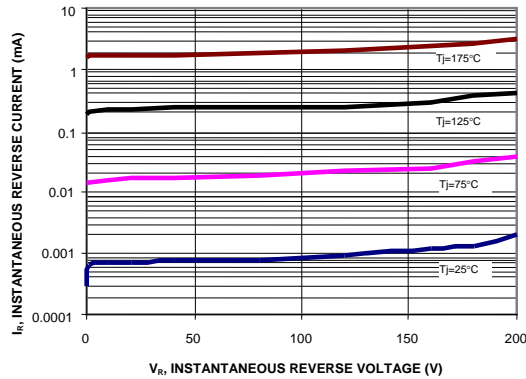

Figure 3: Typical Reverse Characteristics, Per Element

**Ordering Information** (Note 3)

Part Number	Case	Packaging
SBR30200CT	TO-220AB	50 pieces/tube
SBR30200CTFP	ITO-220AB	50 pieces/tube

Notes: 3. For packaging details, go to our website at <http://www.diodes.com/datasheets/ap02007.pdf>.

**Marking Information**

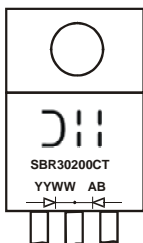

SBR30200CT = Product Type Marking Code  
 AB = Foundry and Assembly Code  
 YYWW = Date Code Marking  
 YY = Last two digits of year, ex: 06 = 2006  
 WW = Week (01-52)

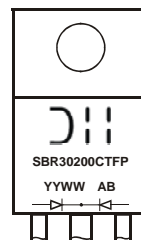

SBR30200CTFP = Product Type Marking Code  
 AB = Foundry and Assembly Code  
 YYWW = Date Code Marking  
 YY = Last two digits of year, ex: 06 = 2006  
 WW = Week (01-52)

**Package Outline Dimensions**

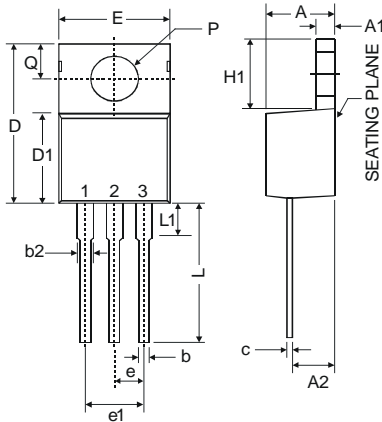

TO-220AB			
Dim	Min	Typ	Max
A	3.56	-	4.82
A1	0.51	-	1.39
A2	2.04	-	2.92
b	0.39	0.81	1.01
c	0.356	-	0.61
D	14.22	-	16.51
D1	8.39	-	9.01
e	2.54		
e1	5.08		
E	9.66	-	10.66
H1	5.85	-	6.85
L	12.70	-	14.73
L1	-	-	6.35
P	3.54	-	4.08
Q	2.54	-	3.42
All Dimensions in mm			

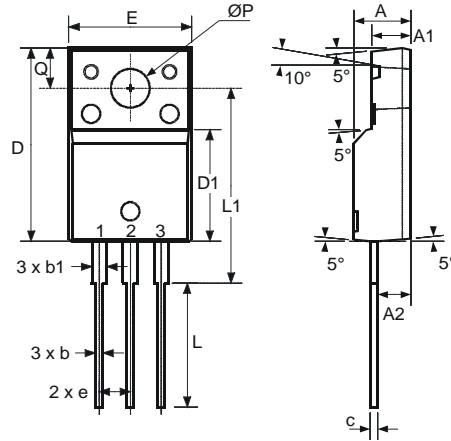

ITO-220AB (Note 4)			
Dim	Min	Typ	Max
A	4.50	4.70	4.90
A1	3.04	3.24	3.44
A2	2.56	2.76	2.96
b	0.50	0.60	0.75
b1	1.10	1.20	1.35
c	0.50	0.60	0.70
D	15.67	15.87	16.07
D1	8.99	9.19	9.39
e	2.54		
E	9.91	10.11	10.31
L	9.45	9.75	10.05
L1	15.80	16.00	16.20
P	2.98	3.18	3.38
Q	3.10	3.30	3.50
All Dimensions in mm			

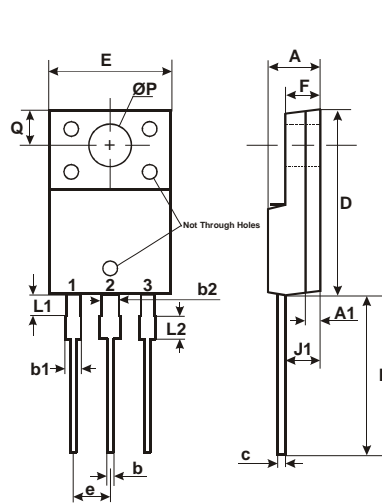

ITO-220AB ALTERNATE (Note 4)		
DIM.	MIN.	MAX.
A	4.30	4.70
A1	1.3	
b	0.50	0.75
b1	1.10	1.35
b2	1.50	1.75
c	0.50	0.75
D	14.80	15.20
E	9.96	10.36
e	2.54 typ	
F	2.80	3.20
J1	2.50	2.90
L	12.80	13.60
L1	1.70	1.90
L2	1.90	2.10
ØP	3.50 typ	
Q	2.70 typ	
All Dimensions in mm		

Notes: 4. For product manufactured with Date Code 0733 (week 33, 2007) and newer, please refer to ITO-220AB dimensions. For product manufactured prior to Date Code 0733, please refer to ITO-220AB ALTERNATE dimensions.

**IMPORTANT NOTICE**

Diodes Incorporated and its subsidiaries reserve the right to make modifications, enhancements, improvements, corrections or other changes without further notice to any product herein. Diodes Incorporated does not assume any liability arising out of the application or use of any product described herein; neither does it convey any license under its patent rights, nor the rights of others. The user of products in such applications shall assume all risks of such use and will agree to hold Diodes Incorporated and all the companies whose products are represented on our website, harmless against all damages.

**LIFE SUPPORT**

Diodes Incorporated products are not authorized for use as critical components in life support devices or systems without the expressed written approval of the President of Diodes Incorporated.