

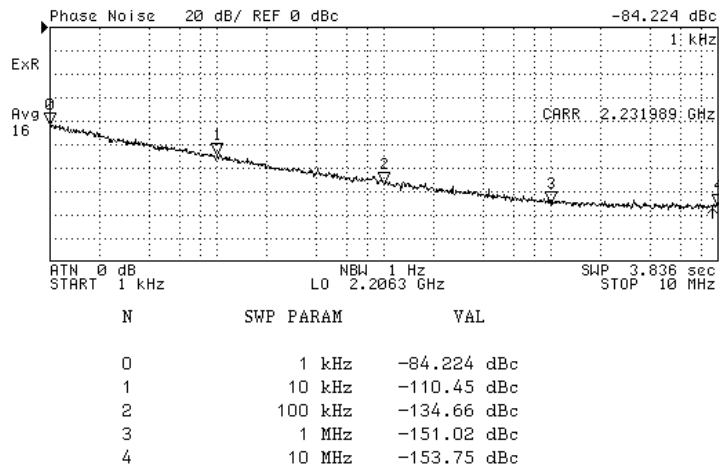

PERFORMANCE SPECIFICATION	MIN	TYP	MAX	UNITS
Lower Frequency:			2200	MHz
Upper Frequency:	2260			MHz
Tuning Voltage:	0.5		4.5	VDC
Supply Voltage:	4.75	5.0	5.25	VDC
Output Power:	-3.0	0	+3.0	dBm
Supply Current:		20	30	mA
Harmonic Suppression (2 <sup>nd</sup> Harmonic):		-30	-20	dBc
Pushing:		0.5	1.0	MHz/V
Pulling, all Phases:		0.5	1.0	MHz pk-pk
Tuning Sensitivity:		20		MHz/V
Phase Noise @ 10kHz offset:		-111	-108	dBc/Hz
Phase Noise @ 100kHz offset:		-134	-130	dBc/Hz
Load Impedance:		50		$\Omega$
Input Capacitance:			22	pF
Operating Temperature Range:	-40		+85	$^{\circ}$ C
Storage Temperature Range:	-45		+90	$^{\circ}$ C

Phase Noise  
(1 Hz BW, Typical)



Tuning Curve  
(Typical)

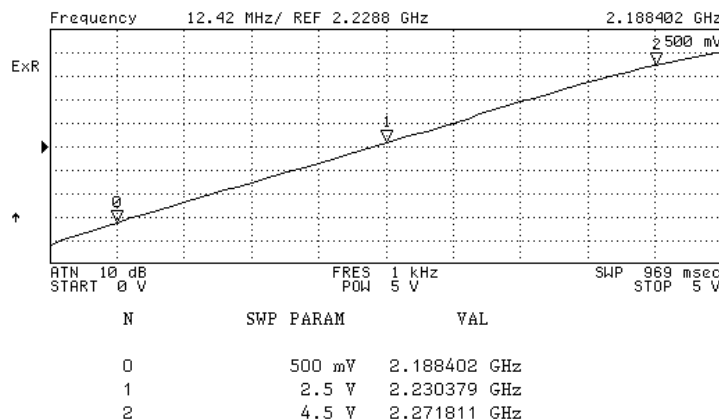

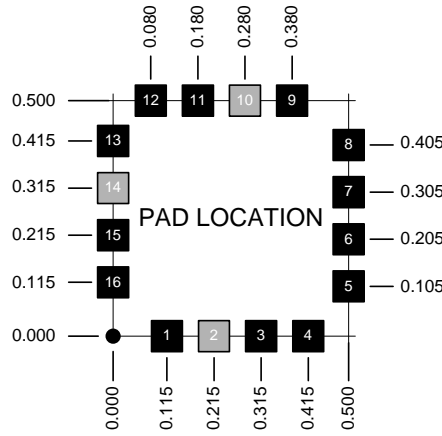
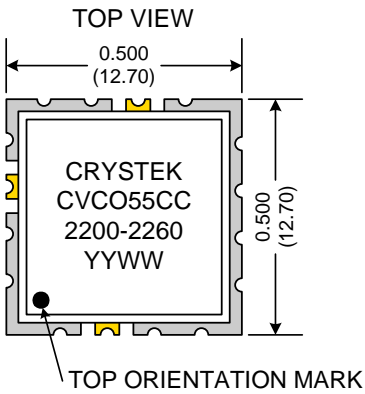
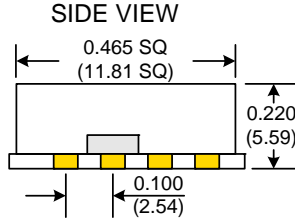
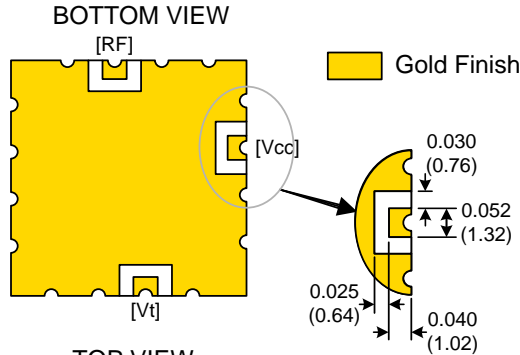

Pad	Connection
2	Vt
10	RF-OUTPUT
14	Vcc
Others	GROUND

- Unless otherwise specified, Dimensions are in:  $\frac{IN}{(mm)}$
- Pad Location Dimensions are in: Inches

**TAPE AND REEL**

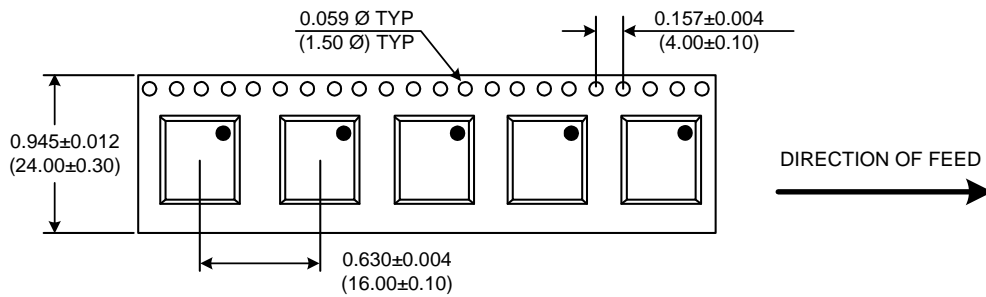

Drawing not to scale

**Product Control:**

Crystek Part Number:	CVCO55CC-2200-2260	Release Date:	18-Feb-08
Revision Level:	B	Responsible:	C. Vales

Specification is subject to change without notice