

AP70L02GS/P

RoHS-compliant Product

N-CHANNEL ENHANCEMENT MODE

POWER MOSFET



**Advanced Power
Electronics Corp.**

- ▼ Low On-resistance
- ▼ Simple Drive Requirement
- ▼ Fast Switching

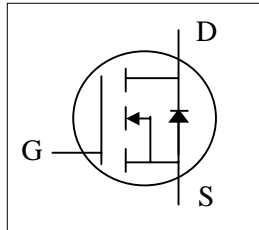

BV_{DSS}	25V
$R_{DS(ON)}$	9m Ω
I_D	66A

Description

The Advanced Power MOSFETs from APEC provide the designer with the best combination of fast switching, ruggedized device design, low on-resistance and cost-effectiveness.

The TO-263 package is universally preferred for all commercial-industrial surface mount applications and suited for low voltage applications such as DC/DC converters. The through-hole version (AP70L02GP) is available for low-profile applications.

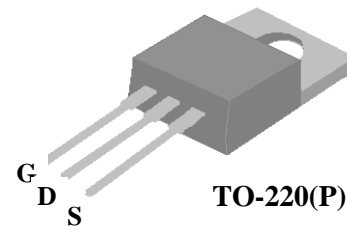
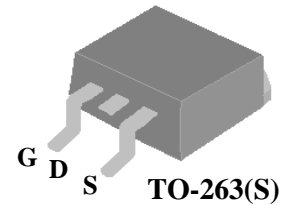

Absolute Maximum Ratings

Symbol	Parameter	Rating	Units
V_{DS}	Drain-Source Voltage	25	V
V_{GS}	Gate-Source Voltage	± 20	V
$I_D @ T_C = 25^\circ C$	Continuous Drain Current, $V_{GS} @ 10V$	66	A
$I_D @ T_C = 100^\circ C$	Continuous Drain Current, $V_{GS} @ 10V$	42	A
I_{DM}	Pulsed Drain Current ¹	210	A
$P_D @ T_C = 25^\circ C$	Total Power Dissipation	66	W
	Linear Derating Factor	0.53	W/ $^\circ C$
T_{STG}	Storage Temperature Range	-55 to 150	$^\circ C$
T_J	Operating Junction Temperature Range	-55 to 150	$^\circ C$

Thermal Data

Symbol	Parameter	Value	Unit
Rthj-case	Thermal Resistance Junction-case Max.	1.9	$^\circ C/W$
Rthj-amb	Thermal Resistance Junction-ambient Max.	62	$^\circ C/W$



AP70L02GS/P

Electrical Characteristics @T_j=25°C(unless otherwise specified)

Symbol	Parameter	Test Conditions	Min.	Typ.	Max.	Units
BV _{DSS}	Drain-Source Breakdown Voltage	V _{GS} =0V, I _D =250uA	25	-	-	V
ΔBV _{DSS} /ΔT _j	Breakdown Voltage Temperature Coefficient	Reference to 25°C, I _D =1mA	-	0.037	-	V/°C
R _{DS(ON)}	Static Drain-Source On-Resistance	V _{GS} =10V, I _D =33A	-	-	9	mΩ
		V _{GS} =4.5V, I _D =20A	-	-	18	mΩ
V _{GS(th)}	Gate Threshold Voltage	V _{DS} =V _{GS} , I _D =250uA	1	-	3	V
g _{fs}	Forward Transconductance	V _{DS} =10V, I _D =33A	-	25	-	S
I _{DSS}	Drain-Source Leakage Current (T _j =25°C)	V _{DS} =25V, V _{GS} =0V	-	-	1	uA
	Drain-Source Leakage Current (T _j =150°C)	V _{DS} =20V, V _{GS} =0V	-	-	25	uA
I _{GSS}	Gate-Source Leakage	V _{GS} =± 20V	-	-	±100	nA
Q _g	Total Gate Charge ²	I _D =33A	-	23		nC
Q _{gs}	Gate-Source Charge	V _{DS} =20V	-	3		nC
Q _{gd}	Gate-Drain ("Miller") Charge	V _{GS} =5V	-	17		nC
t _{d(on)}	Turn-on Delay Time ²	V _{DS} =15V	-	8.8	-	ns
t _r	Rise Time	I _D =33A	-	95	-	ns
t _{d(off)}	Turn-off Delay Time	R _G =3.3Ω, V _{GS} =10V	-	24	-	ns
t _f	Fall Time	R _D =0.45Ω	-	14	-	ns
C _{iss}	Input Capacitance	V _{GS} =0V	-	790	-	pF
C _{oss}	Output Capacitance	V _{DS} =25V	-	475	-	pF
C _{rss}	Reverse Transfer Capacitance	f=1.0MHz	-	195	-	pF

Source-Drain Diode

Symbol	Parameter	Test Conditions	Min.	Typ.	Max.	Units
I _S	Continuous Source Current (Body Diode)	V _D =V _G =0V , V _S =1.26V	-	-	66	A
I _{SM}	Pulsed Source Current (Body Diode) ¹		-	-	210	A
V _{SD}	Forward On Voltage ²	T _j =25°C , I _S =66A, V _{GS} =0V	-	-	1.26	V

Notes:

- 1.Pulse width limited by Max. junction temperature.
- 2.Pulse test

THIS PRODUCT IS AN ELECTROSTATIC SENSITIVE, PLEASE HANDLE WITH CAUTION.

THIS PRODUCT HAS BEEN QUALIFIED FOR CONSUMER MARKET. APPLICATIONS OR USES AS CRITERIAL COMPONENT IN LIFE SUPPORT DEVICE OR SYSTEM ARE NOT AUTHORIZED.

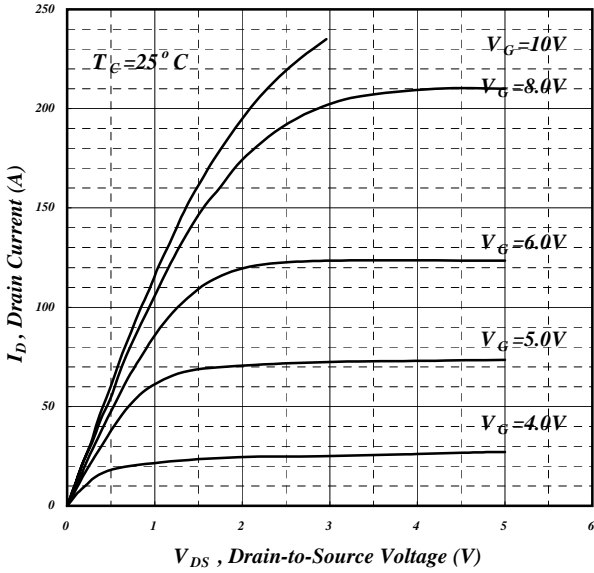

Fig 1. Typical Output Characteristics

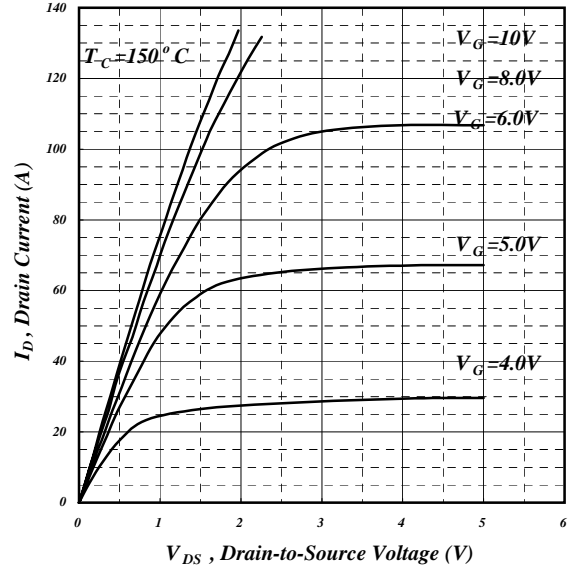

Fig 2. Typical Output Characteristics

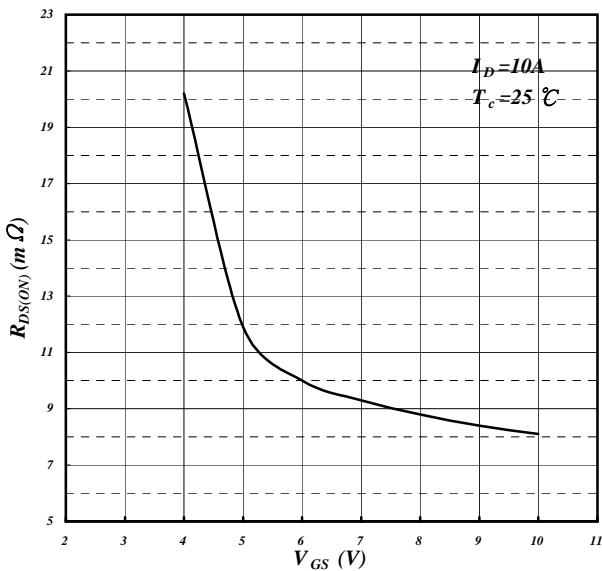

Fig 3. On-Resistance v.s. Gate Voltage

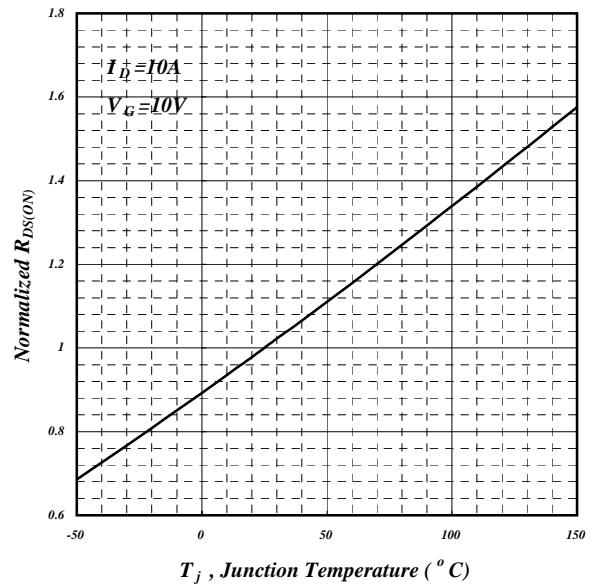

Fig 4. Normalized On-Resistance v.s. Junction Temperature

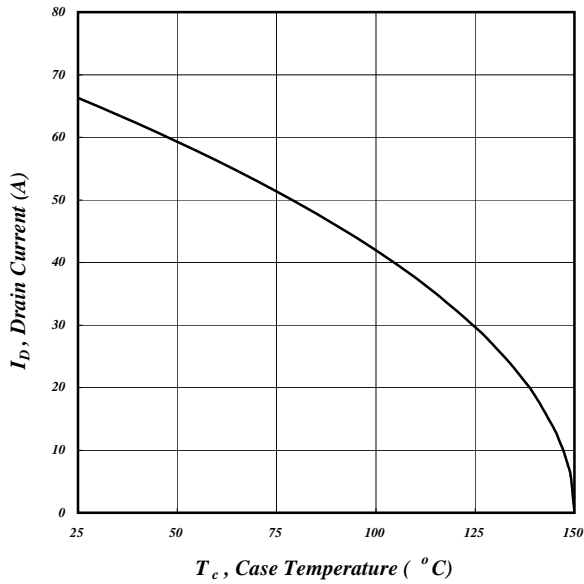

Fig 5. Maximum Drain Current v.s. Case Temperature

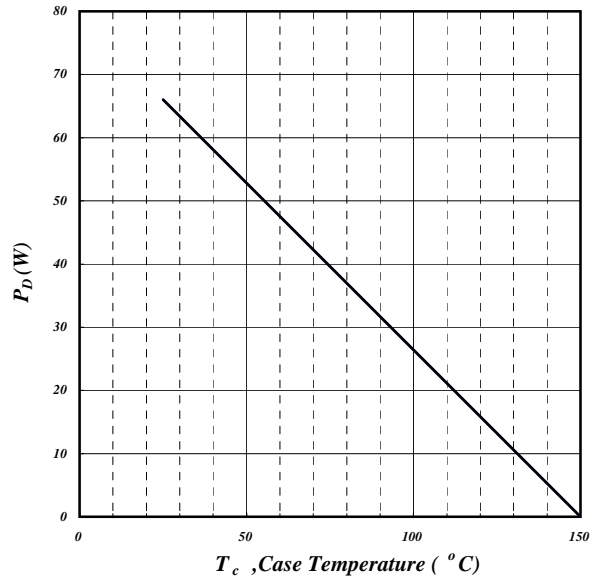

Fig 6. Typical Power Dissipation

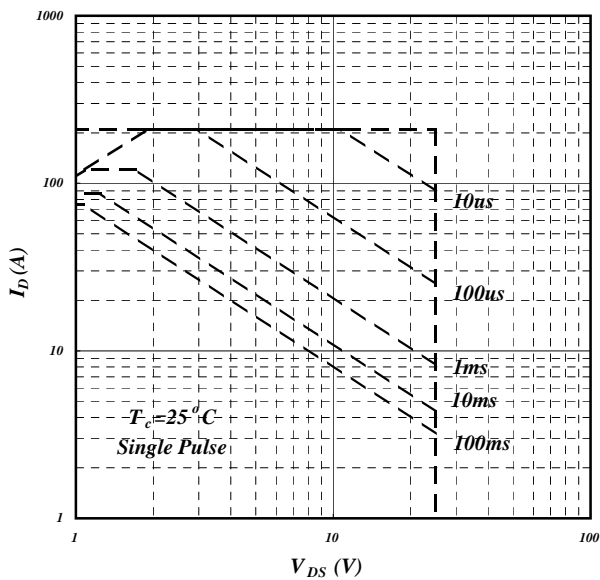

Fig 7. Maximum Safe Operating Area

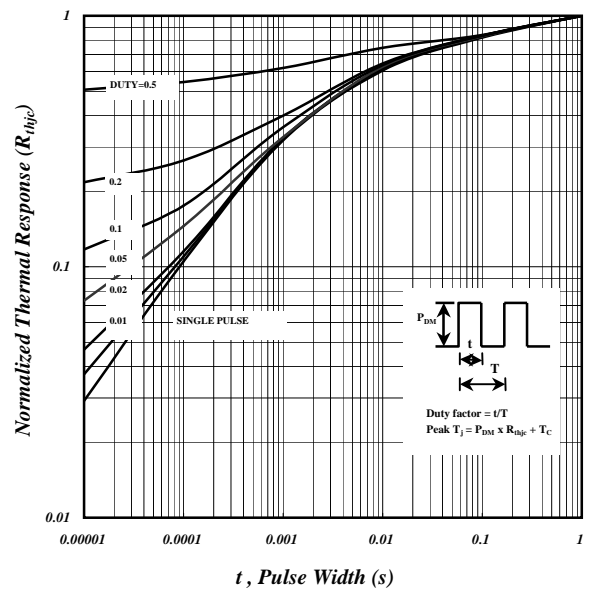

Fig 8. Effective Transient Thermal Impedance

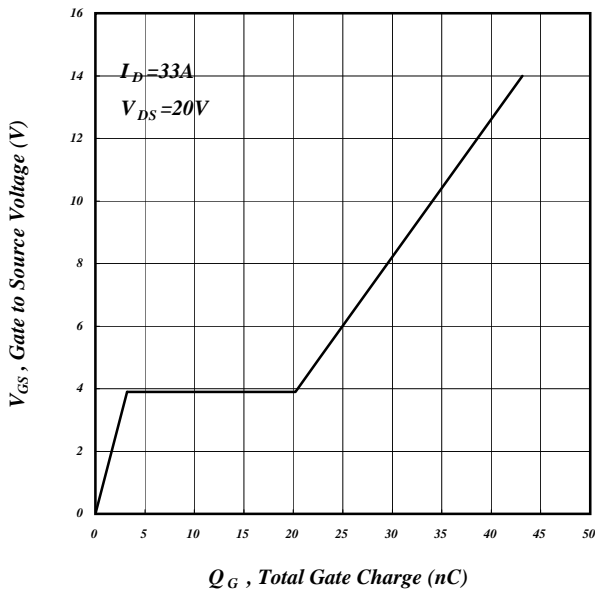

Fig 9. Gate Charge Characteristics

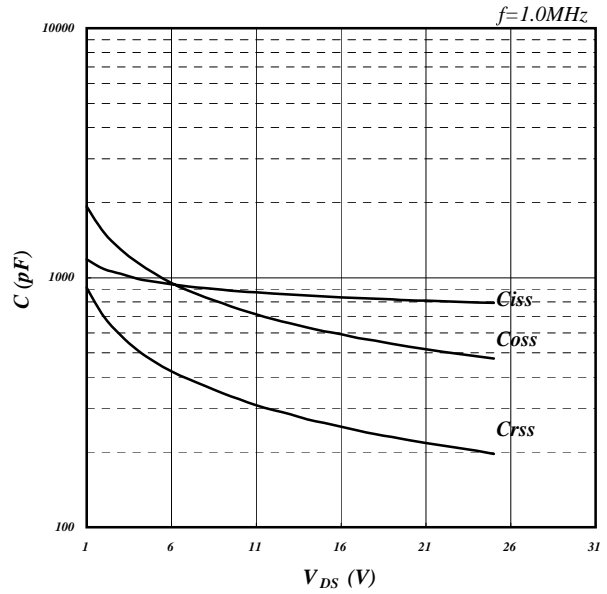

Fig 10. Typical Capacitance Characteristics

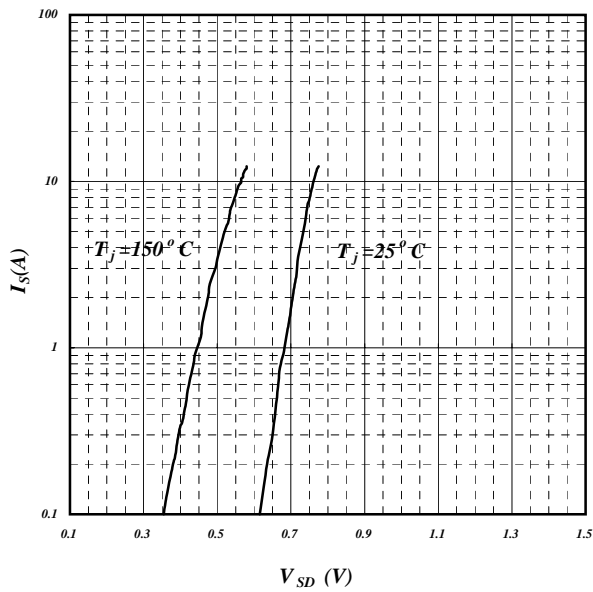

Fig 11. Forward Characteristic of Reverse Diode

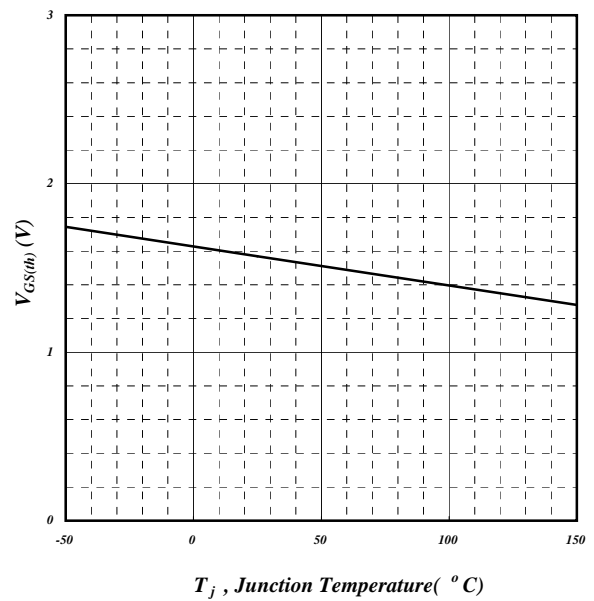

Fig 12. Gate Threshold Voltage v.s. Junction Temperature

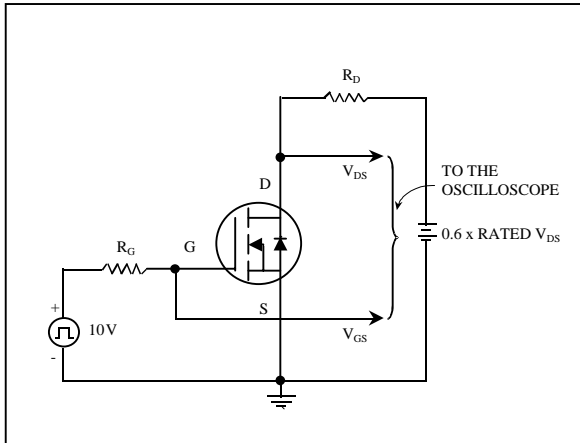

Fig 13. Switching Time Circuit

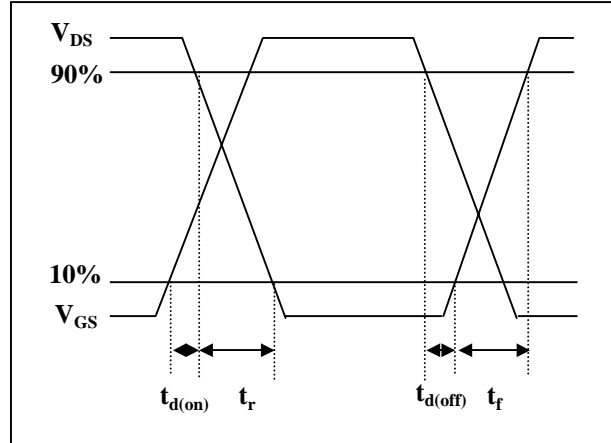

Fig 14. Switching Time Waveform

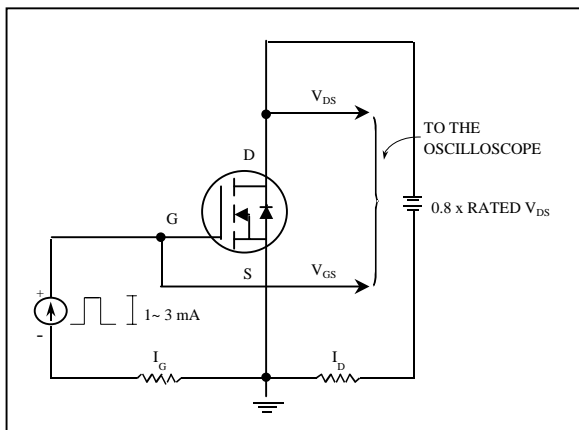

Fig 15. Gate Charge Circuit

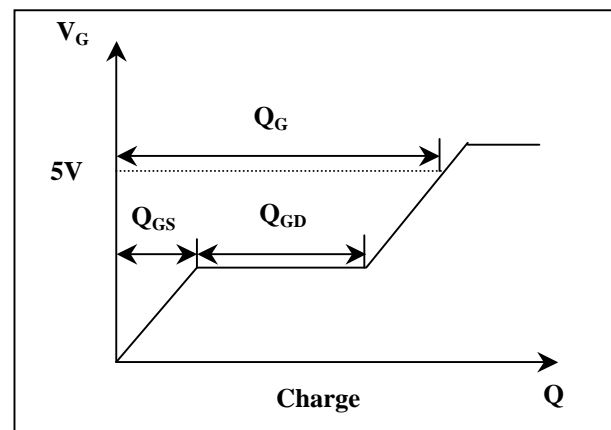
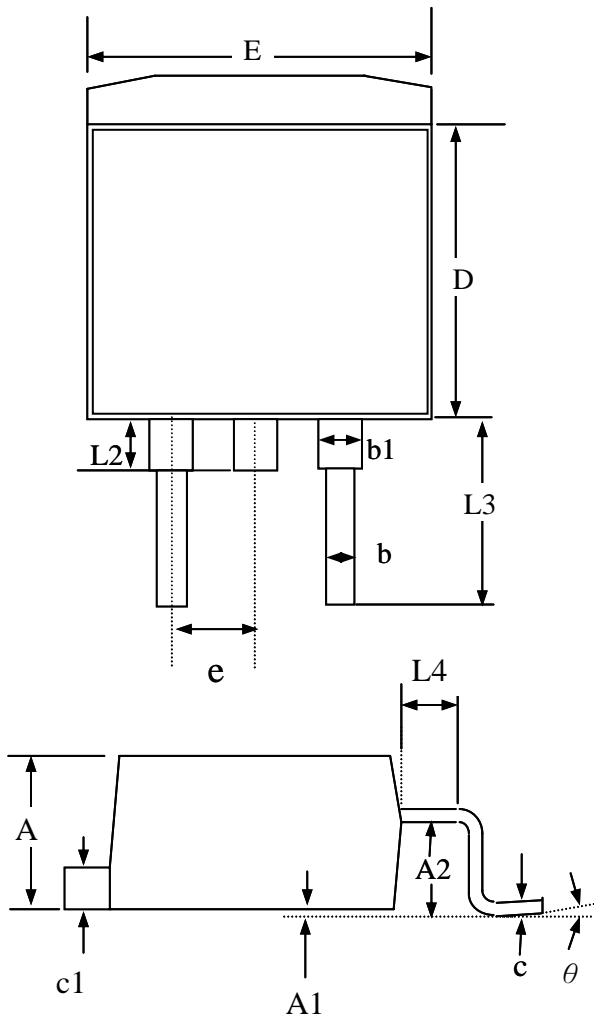

Fig 16. Gate Charge Waveform



Package Outline : TO-263



SYMBOLS	Millimeters		
	MIN	NOM	MAX
A	4.25	4.75	5.20
A1	0.00	0.15	0.30
A2	2.20	2.45	2.70
b	0.70	0.90	1.10
b1	1.07	1.27	1.47
c	0.30	0.45	0.60
c1	1.15	1.30	1.45
D	8.30	8.90	9.40
E	9.70	10.10	10.50
e	2.04	2.54	3.04
L2	-----	1.50	-----
L3	4.50	4.90	5.30
L4	-----	1.50	----

- 1.All Dimensions Are in Millimeters.
- 2.Dimension Does Not Include Mold Protrusions.

Part Marking Information & Packing : TO-263

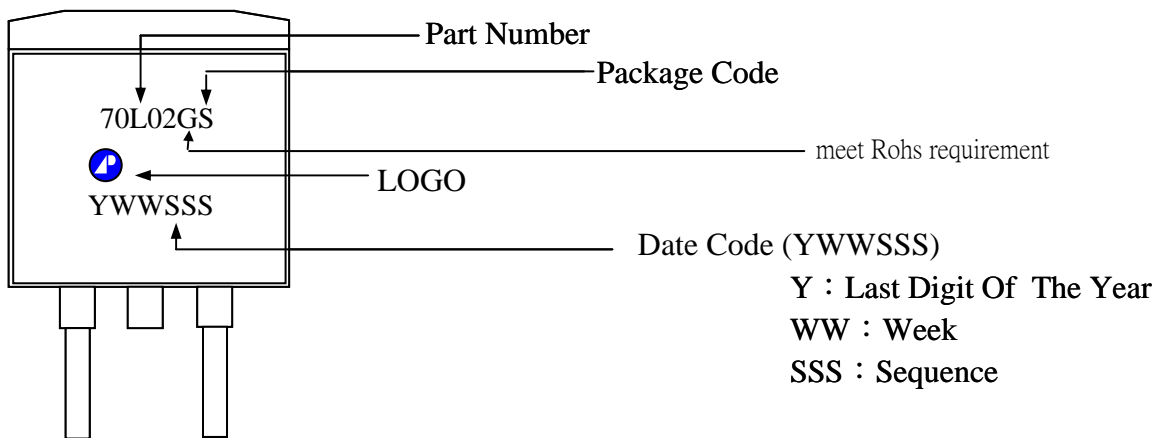



Package Outline : TO-220

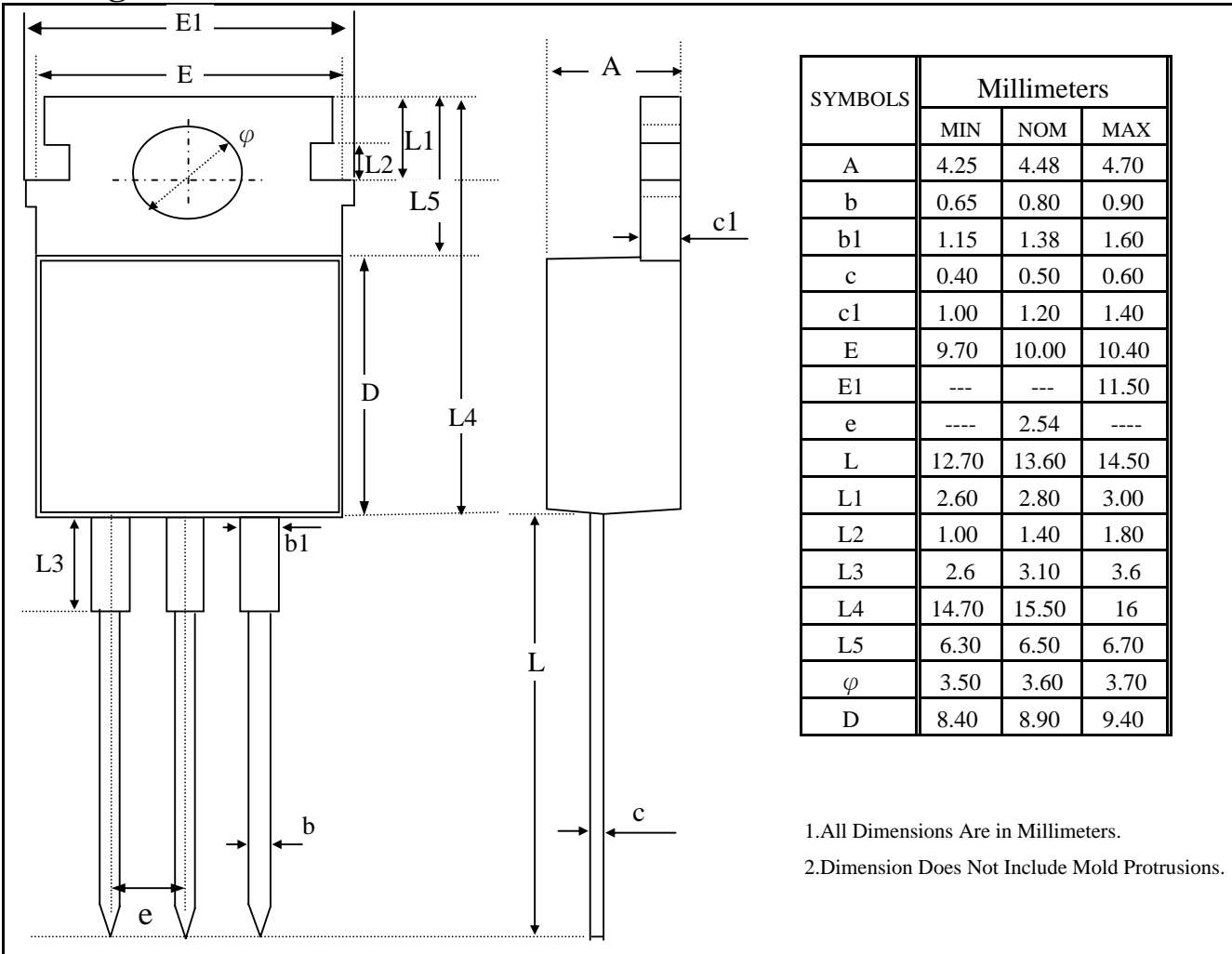

Part Marking Information & Packing : TO-220

