

Features

- SOT-23 PACKAGE SURFACE MOUNT LED LAMP.
- LOW POWER CONSUMPTION.
- LONG LIFE - SOLID STATE RELIABILITY.
- PACKAGE: 2000PCS / REEL.
- MOISTURE SENSITIVITY LEVEL : LEVEL 3.
- RoHS COMPLIANT.

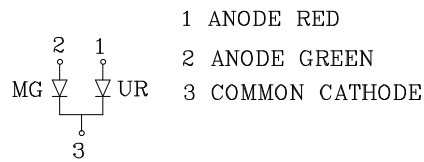
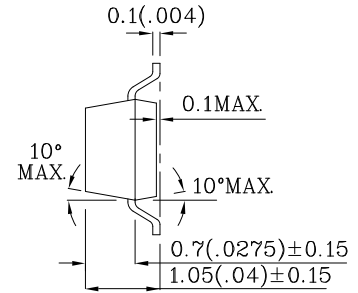
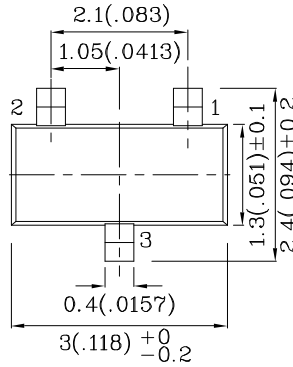

Notes:

1. All dimensions are in millimeters (inches).
2. Tolerance is ± 0.25(0.01") unless otherwise noted.
3. Specifications are subject to change without notice.

Absolute Maximum Ratings (TA=25°C)		UR (GaAsP/ GaP)	MG (GaP)	Unit
Reverse Voltage	VR	5	5	V
Forward Current	IF	30	25	mA
Forward Current (Peak) 1/10 Duty Cycle 0.1ms Pulse Width	iFS	160	140	mA
Power Dissipation	PT	75	62.5	mW
Operating Temperature	TA	-40 ~ +85		°C
Storage Temperature	Tstg	-40 ~ +85		

Operating Characteristics (TA=25°C)		UR (GaAsP/ GaP)	MG (GaP)	Unit
Forward Voltage (Typ.) (IF=20mA)	VF	2.0	2.2	V
Forward Voltage (Max.) (IF=20mA)	VF	2.5	2.5	V
Reverse Current (Max.) (VR=5V)	IR	10	10	uA
Wavelength of Peak Emission (Typ.) (IF=20mA)	λ P	627	565	nm
Wavelength of Dominant Emission (Typ.) (IF=20mA)	λ D	625	568	nm
Spectral Line Full Width At Half-Maximum (Typ.) (IF=20mA)	Δλ	45	30	nm
Capacitance (Typ.) (VF=0V, f=1MHz)	C	15	15	pF

Part Number	Emitting Color	Emitting Material	Lens-color	Luminous Intensity (IF=20mA) mcd		Wavelength nm λ P	Viewing Angle 2 θ 1/2
				min.	typ.		
ZURMG48W	Red	GaAsP/GaP	Water Clear	4	14	627	140°
	Green	GaP		4	14	565	

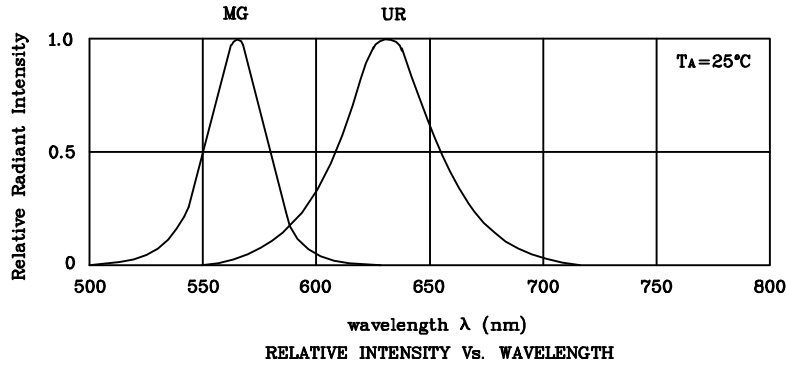

❖ UR

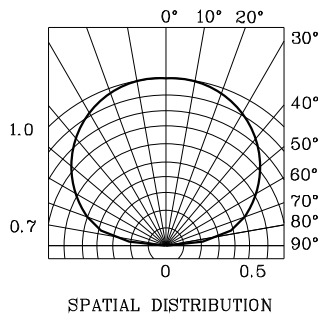
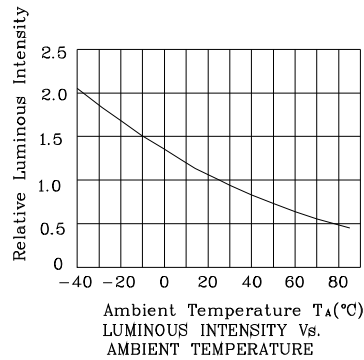
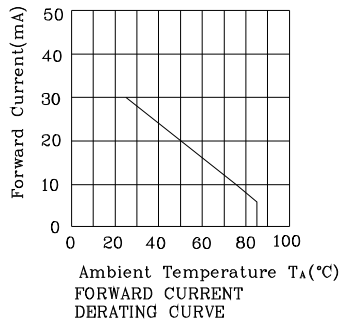
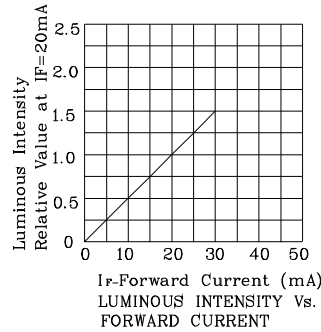
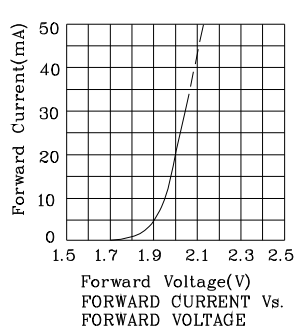

❖ MG

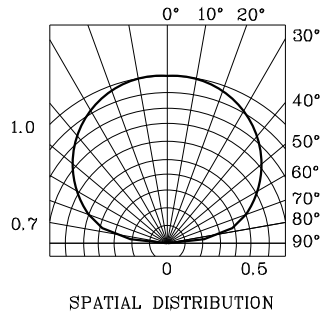
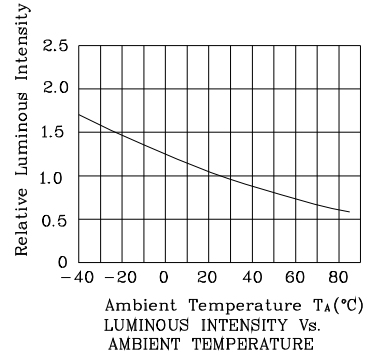
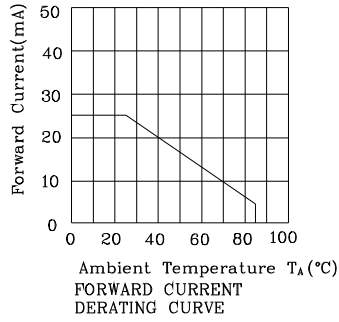
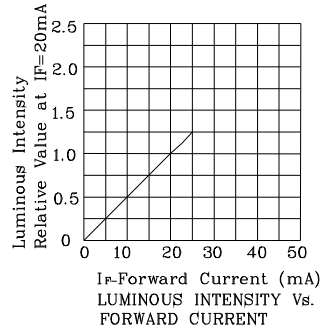
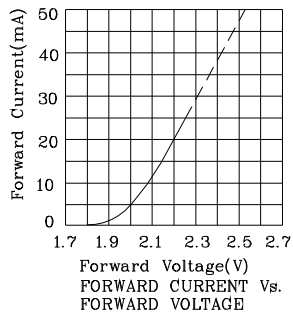

Reflow Soldering Profile For Lead-free SMT Process.

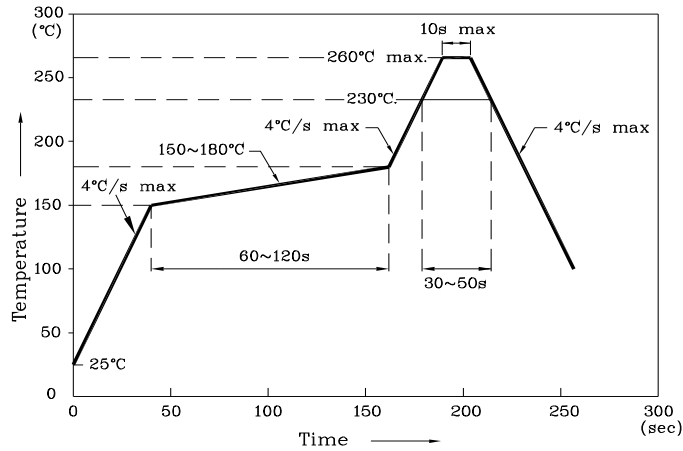

Notes:

1. Maximum soldering temperature should not exceed 260°C.
2. Recommended reflow temperature: 145°C-260°C.
3. Do not put stress to the epoxy resin during high temperatures conditions.

❖ Recommended Soldering Pattern (Units : mm; Tolerance: ± 0.1)

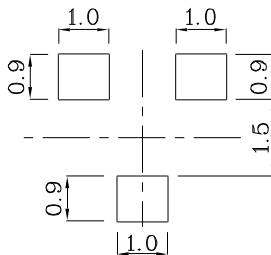

❖ The device has a single mounting surface. The device must be mounted according to the specifications.

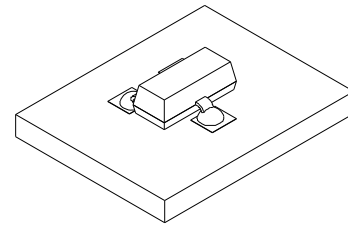

❖ Tape Specification (Units : mm)

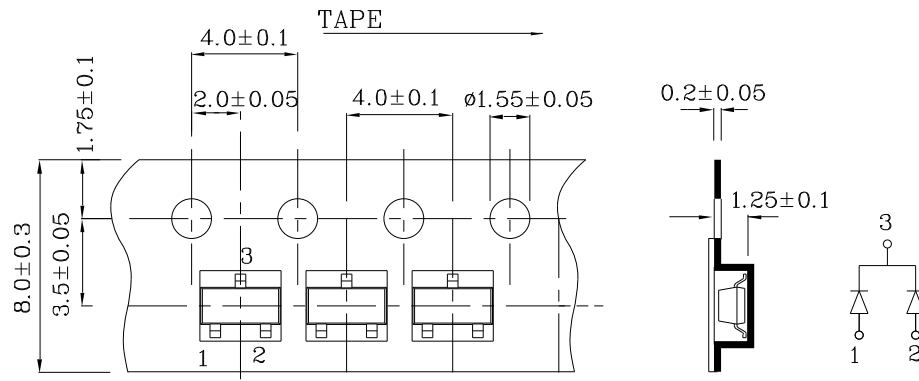

Remarks:

If special sorting is required (e.g. binning based on forward voltage, luminous intensity / luminous flux or wavelength), the typical accuracy of the sorting process is as follows:

1. Wavelength: +/-1nm
2. Luminous Intensity / luminous flux: +/-15%
3. Forward Voltage: +/-0.1V

Note: Accuracy may depend on the sorting parameters.

PACKING & LABEL SPECIFICATIONS

ZURMG48W

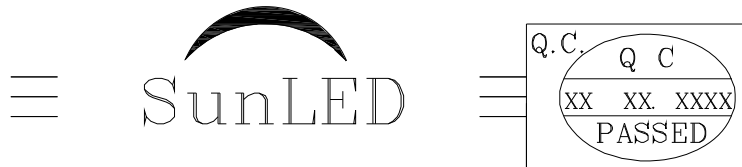
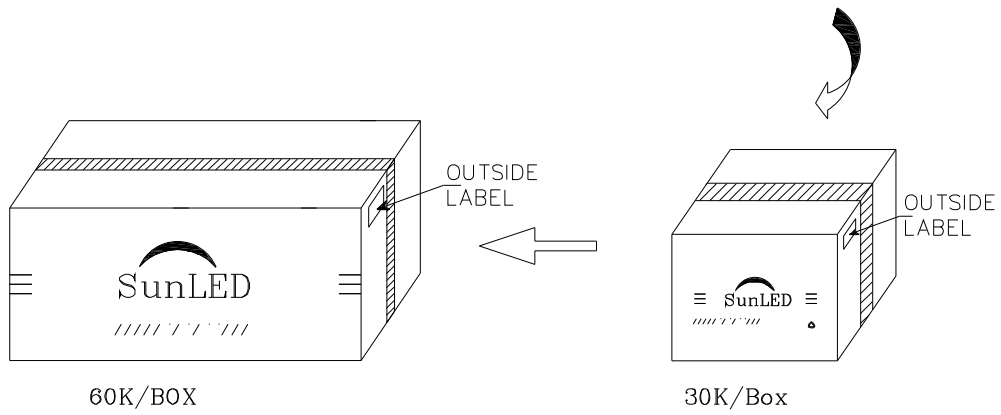
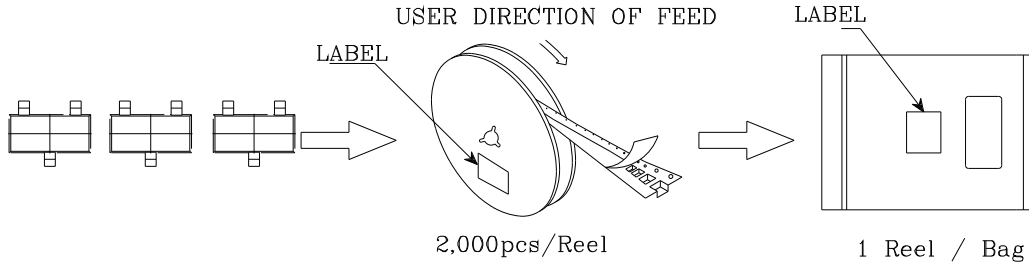

P/NO : Zxxx48x	
QTY : 2,000 pcs	CODE: XXX
S/N : XX	
LOT NO :	
 XXXXXXXXXXXXXXXXXXXXXXXXXXXX	
RoHS Compliant	