

T143-500



Phase Control Thyristor



Type	V_{RSM}, V_{DSM}	V_{RRM}, V_{DRM}
T143-500-4	500	400
T143-500-6	700	600
T143-500-8	900	800
T143-500-10	1100	1000
T143-500-12	1300	1200
T143-500-14	1500	1400
T143-500-16	1700	1600

Symbol	Parameter	Test Conditions	Value	Unit
I_{TAVM}	average on-state current	$T_C=75^\circ\text{C}$	500	A
I_{TRMS}	maximum RMS on-state current	$T_J=T_{JM}$	1160	A
I_{TSM}	surge-current	$T_C=25^\circ\text{C}; t_p=10\text{ms}$	12.0	kA
		$T_J=T_{JM}; t_p=10\text{ms}$	10.8	
i^2t	i^2t -value	$T_C=25^\circ\text{C}; t_p=10\text{ms}$	720	$\text{kA}^2\cdot\text{s}$
		$T_J=T_{JM}; t_p=10\text{ms}$	605	
$(di/dt)_{cr}$	critical rate of rise of on-state current	$T_J=T_{JM}; V_D=0.67\cdot V_{DRM}; f=50\text{ Hz}; I_{GM}=1\text{A}; di_G/dt=1\text{A}/\mu\text{s}$	100	$\text{A}/\mu\text{s}$
$(dv/dt)_{cr}$	critical rate of rise of off-state voltage	$T_J=T_{JM}; V_D=0.67\cdot V_{DRM}; \text{gate open}$	1000	$\text{V}/\mu\text{s}$
I_{RRM}/I_{DRM}	off-state Leakage current	$T_J=T_{JM}; V_R=V_{RRM}; V_D=V_{DRM}$	30	mA
V_{RRM}	reverse repeat peak value voltage	$T_J=T_{JM}; 180^\circ\text{C sine wave, 50 Hz; gate open}$	300-2400	V
V_{DRM}	off state repeat peak value voltage		300-2400	V
V_{RSM}	non-repetitive peak reverse voltage	$T_J=T_{JM}$	400-2500	V
V_{TM}	on-state voltage	$T_J=T_{JM}; I_{TM}=1500\text{A}$	1.80	V
r_T	slope resistance	$T_J=T_{JM}$	0.57	m
V_{GT}	gate trigger voltage	$T_J=25^\circ\text{C}; V_D=12\text{V}$	3.50	V
I_{GT}	gate trigger current	$T_J=25^\circ\text{C}; V_D=12\text{V}$	0.25	A
V_{GD}	gate non-trigger voltage	$T_J=T_{JM}; V_D=0.67\cdot V_{DRM}$	0.50	V
I_{GD}	gate non-trigger current	$T_J=T_{JM}; V_D=0.67\cdot V_{DRM}$	10.0	mA
I_H	holding current	$T_J=25^\circ\text{C}; V_D=12\text{V}; \text{gate open}$	300	mA
I_L	latching current	$T_J=25^\circ\text{C}; V_D=12\text{V}; t_G=20\mu\text{s}; I_{GM}=1\text{A}; di_G/dt=1\text{A}/\mu\text{s}$	700	mA

t_{gd}	delay time	$T_J=25^{\circ}\text{C}; V_D=0.5 \cdot V_{DRM}; I_{GM}=1\text{A}; di_G/dt=1\text{A}/\mu\text{s}$	7	μs
t_q	turn-off time	$T_J=T_{JM}; I_T=I_{TAVM}; di_R/dt=5\text{A}/\mu\text{s}; V_D=0.67 \cdot V_{DRM}; V_R=100\text{V}; dV_D/dt=50\text{V}/\mu\text{s}$	250	μs
V_{TO}	threshold voltage	$T_J=T_{JM}$	1.10	V
T_J	working junction temperature		-60...+125	$^{\circ}\text{C}$
T_{JM}	maximum working junction temperature		125	$^{\circ}\text{C}$
T_{stg}	storage temperature		-60...+50	$^{\circ}\text{C}$
R_{thJC}	thermal resistance; junction to case	DC, two-sided cooling	0.034	$^{\circ}\text{C}/\text{W}$
F	clamping force		14...17	kN
W	weight		260	g
a	maximum allowable acceleration		50	m/s^2

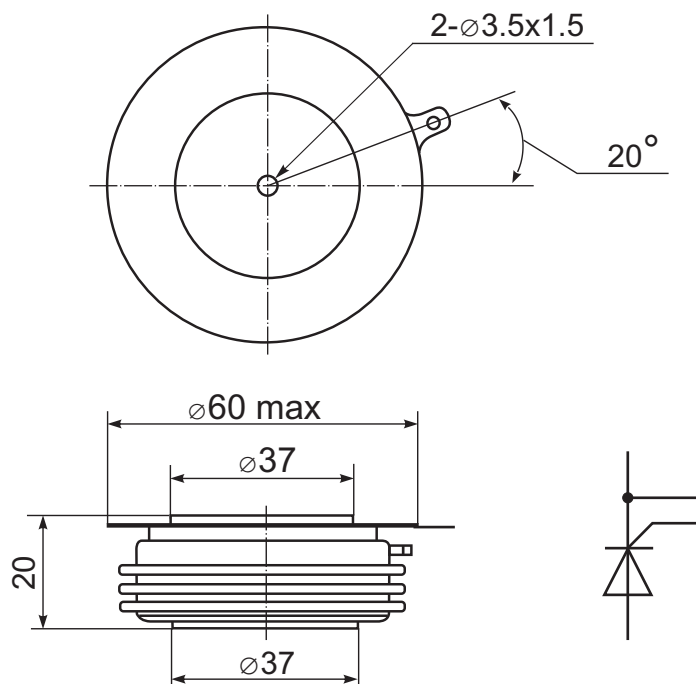

Features:

- Hermetic metal case with ceramic insulator
- Capsule packages for double sided cooling
- International standard case
- Amplifying gates

Typical Applications:

- DC motor control
- AC motor soft starter
- Controlled rectifiers
- AC controllers

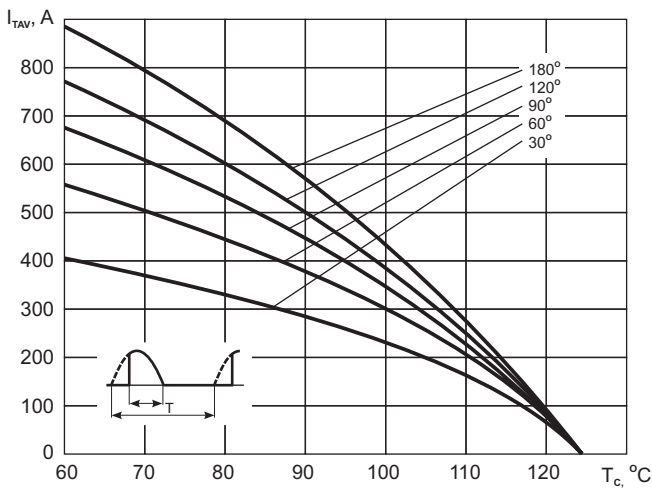

Max. case temperature vs. average on-state current, sine waveform, $f=50\text{Hz}$, $T=1/f$

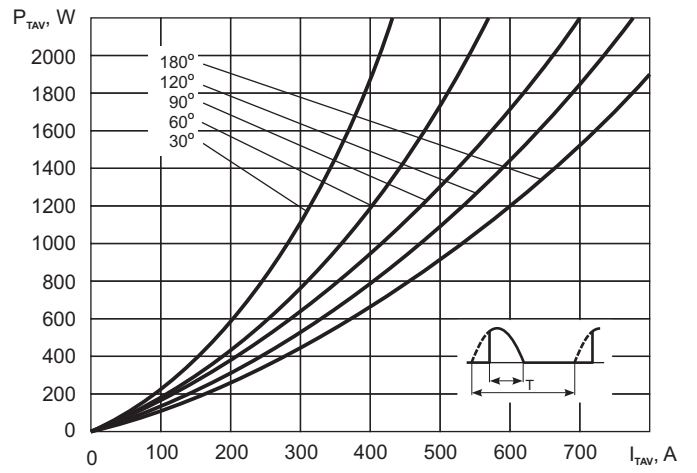

On-state power loss vs. average on-state current, sine waveform, $f=50\text{Hz}$, $T=1/f$

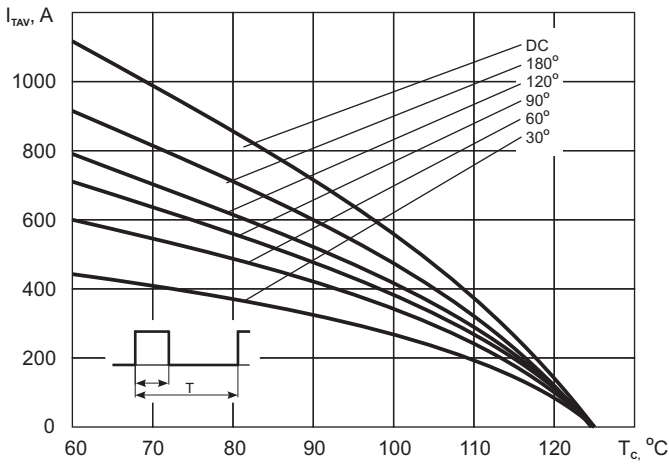

Max. case temperature vs. average on-state current, square waveform, $f=50\text{Hz}$, $T=1/f$

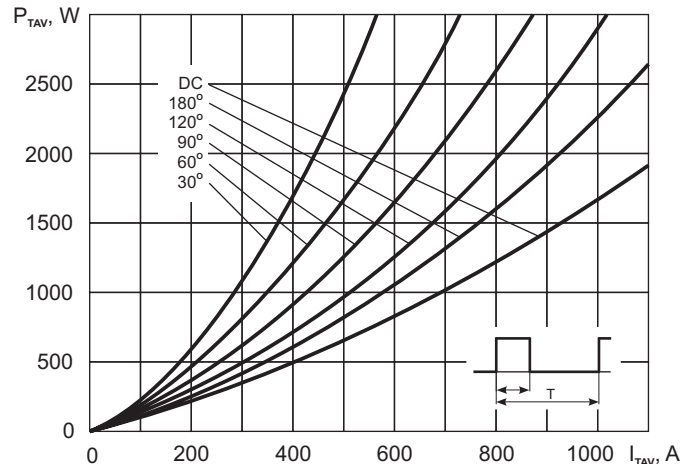

On-state power loss vs. average on-state current, square waveform, $f=50\text{Hz}$, $T=1/f$

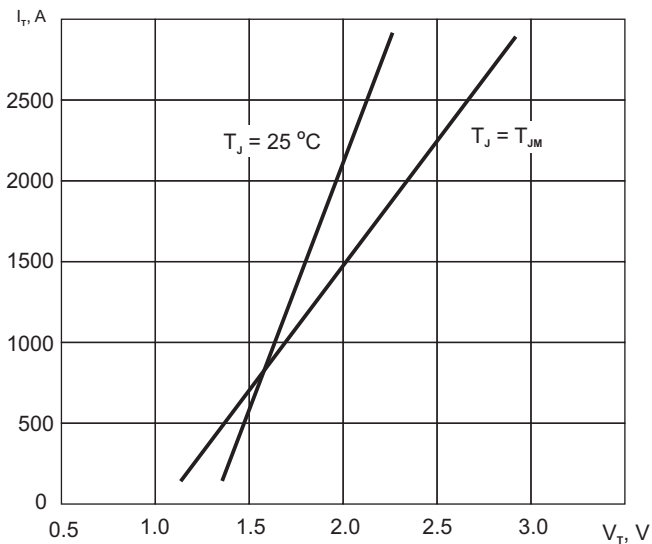

Limiting on-state characteristic $I_T = f(V_T)$

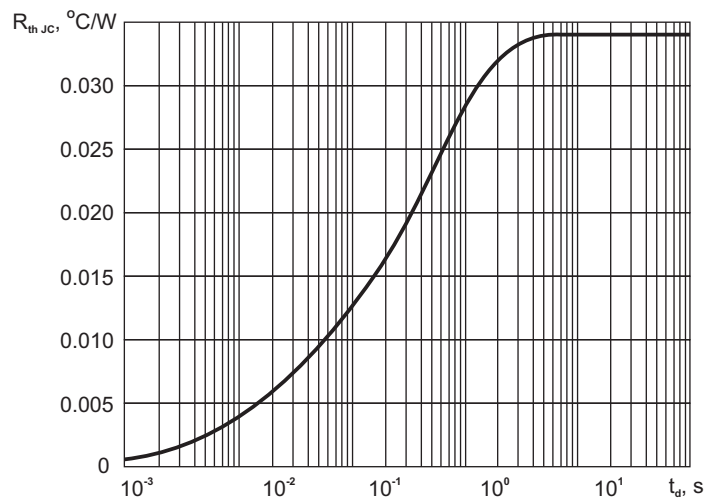

Transient thermal impedance $R_{th,JC} = f(t_d)$
 t_d - square wave pulse duration