

$V_{CE} = 1700\text{ V}$
 $I_C = 100\text{ A}$

IGBT-Die

5SMX 12M1701



Die size: 13.6 x 13.6 mm

Doc. No. 5SYA1620-01 July 03

- Low loss thin IGBT die
- Highly rugged SPT design
- Large front bondable area
- Frontside passivation: polyimide

Maximum rated values ¹⁾

Parameter	Symbol	Conditions	min	max	Unit
Collector-emitter voltage	V_{CES}	$V_{GE} = 0\text{ V}, T_{vj} \geq 25\text{ °C}$		1700	V
DC collector current	I_C			100	A
Peak collector current	I_{CM}	Limited by T_{vjmax}		200	A
Gate-emitter voltage	V_{GES}		-20	20	V
IGBT short circuit SOA	t_{psc}	$V_{CC} = 1300\text{ V}, V_{CEM} \leq 1700\text{ V}$ $V_{GE} \leq 15\text{ V}, T_{vj} \leq 125\text{ °C}$		10	μs
Junction temperature	T_{vj}		-40	150	$^{\circ}\text{C}$

1) Maximum rated values indicate limits beyond which damage to the device may occur

ABB Switzerland Ltd, Semiconductors reserves the right to change specifications without notice.

IGBT characteristic values

Parameter	Symbol	Conditions	min	typ	max	Unit	
Collector (-emitter) breakdown voltage	$V_{(BR)CES}$	$V_{GE} = 0 \text{ V}$, $I_C = 1 \text{ mA}$, $T_{vj} = 25 \text{ }^\circ\text{C}$	1700			V	
Collector-emitter saturation voltage	$V_{CE \text{ sat}}$	$I_C = 100 \text{ A}$, $V_{GE} = 15 \text{ V}$	$T_{vj} = 25 \text{ }^\circ\text{C}$	2.1	2.3	2.7	V
			$T_{vj} = 125 \text{ }^\circ\text{C}$		2.6		V
Collector cut-off current	I_{CES}	$V_{CE} = 1700 \text{ V}$, $V_{GE} = 0 \text{ V}$	$T_{vj} = 25 \text{ }^\circ\text{C}$			100	μA
			$T_{vj} = 125 \text{ }^\circ\text{C}$		800		μA
Gate leakage current	I_{GES}	$V_{CE} = 0 \text{ V}$, $V_{GE} = \pm 20 \text{ V}$, $T_{vj} = 125 \text{ }^\circ\text{C}$	-500		500	nA	
Gate-emitter threshold voltage	$V_{GE(TO)}$	$I_C = 4 \text{ mA}$, $V_{CE} = V_{GE}$, $T_{vj} = 25 \text{ }^\circ\text{C}$	4.5		6.5	V	
Gate charge	Q_{ge}	$I_C = 100 \text{ A}$, $V_{CE} = 900 \text{ V}$, $V_{GE} = -15 \dots 15 \text{ V}$		880		nC	
Input capacitance	C_{ies}	$V_{CE} = 25 \text{ V}$, $V_{GE} = 0 \text{ V}$, $f = 1 \text{ MHz}$, $T_{vj} = 25 \text{ }^\circ\text{C}$		9.5		nF	
Output capacitance	C_{oes}			0.64			
Reverse transfer capacitance	C_{res}			0.40			
Internal gate resistance	R_{Gint}			4		Ω	
Turn-on delay time	$t_{d(on)}$	$V_{CC} = 900 \text{ V}$, $I_C = 100 \text{ A}$, $R_G = 10 \text{ } \Omega$, $V_{GE} = \pm 15 \text{ V}$,	$T_{vj} = 25 \text{ }^\circ\text{C}$		160	ns	
			$T_{vj} = 125 \text{ }^\circ\text{C}$		170		
Rise time	t_r	$L_\sigma = 160 \text{ nH}$, inductive load	$T_{vj} = 25 \text{ }^\circ\text{C}$		100	ns	
			$T_{vj} = 125 \text{ }^\circ\text{C}$		110		
Turn-off delay time	$t_{d(off)}$	$V_{CC} = 900 \text{ V}$, $I_C = 100 \text{ A}$, $R_G = 10 \text{ } \Omega$, $V_{GE} = \pm 15 \text{ V}$,	$T_{vj} = 25 \text{ }^\circ\text{C}$		400	ns	
			$T_{vj} = 125 \text{ }^\circ\text{C}$		480		
Fall time	t_f	$L_\sigma = 160 \text{ nH}$, inductive load	$T_{vj} = 25 \text{ }^\circ\text{C}$		90	ns	
			$T_{vj} = 125 \text{ }^\circ\text{C}$		110		
Turn-on switching energy	E_{on}	$V_{CC} = 900 \text{ V}$, $I_C = 100 \text{ A}$, $V_{GE} = \pm 15 \text{ V}$, $R_G = 10 \text{ } \Omega$, $L_\sigma = 160 \text{ nH}$, inductive load, FWD: 5SLX12H1700	$T_{vj} = 25 \text{ }^\circ\text{C}$		22	mJ	
			$T_{vj} = 125 \text{ }^\circ\text{C}$		32		
Turn-off switching energy	E_{off}	$V_{CC} = 900 \text{ V}$, $I_C = 100 \text{ A}$, $V_{GE} = \pm 15 \text{ V}$, $R_G = 10 \text{ } \Omega$, $L_\sigma = 160 \text{ nH}$, inductive load	$T_{vj} = 25 \text{ }^\circ\text{C}$		17	mJ	
			$T_{vj} = 125 \text{ }^\circ\text{C}$		27		
Short circuit current	I_{SC}	$t_{psc} \leq 10 \text{ } \mu\text{s}$, $V_{GE} = 15 \text{ V}$, $T_{vj} = 125 \text{ }^\circ\text{C}$, $V_{CC} = 1300 \text{ V}$, $V_{CEM} \leq 1700 \text{ V}$		470		A	

Mechanical properties

Parameter				Unit
Dimensions	Overall die	L x W	13.6 x 13.6	mm
	exposed front metal	L x W (except gate pad)	11.6 x 11.6	mm
	gate pad	L x W	1.2 x 1.2	mm
	thickness		210 ± 15	µm
Metallization ¹⁾	front	AlSi1	4	µm
	back	Al / Ti / Ni / Ag	1.2	µm

1) For assembly instructions refer to : IGBT and Diode chips from ABB Switzerland Ltd, Semiconductors, Doc. No. 5SYA2033-01 April 02.

Outline drawing

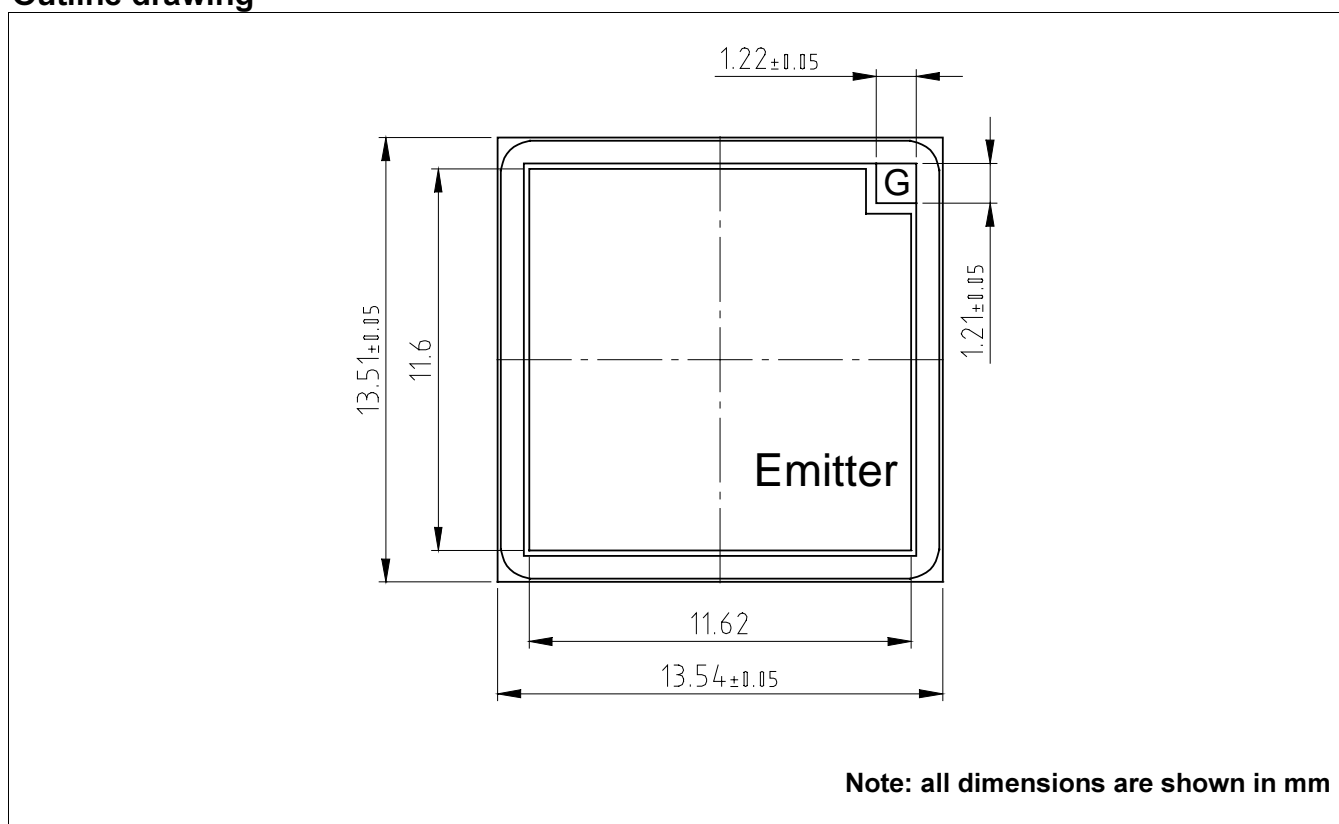

This is an electrostatic sensitive device, please observe the international standard IEC 60747-1, Chap. IX.

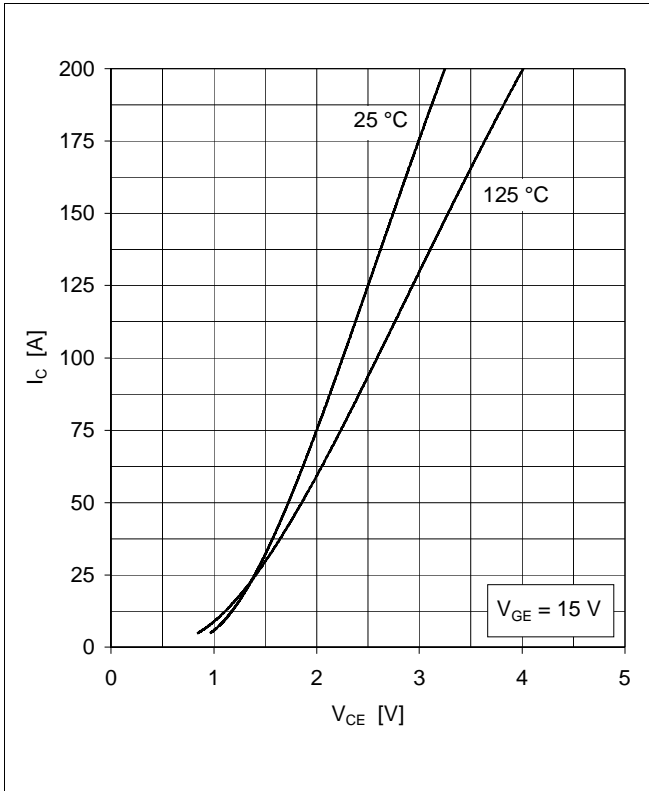

Fig. 1 Typical onstate characteristics

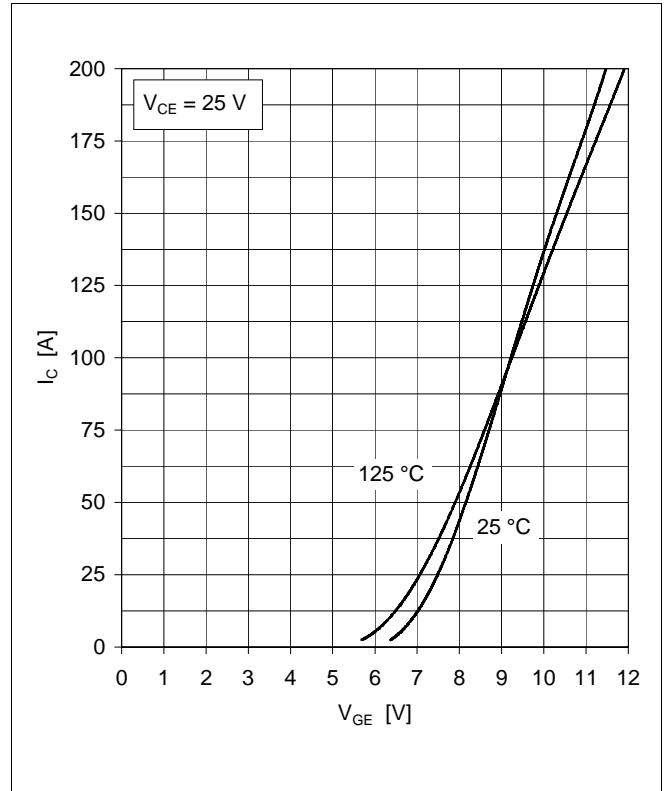

Fig. 2 Typical transfer characteristics

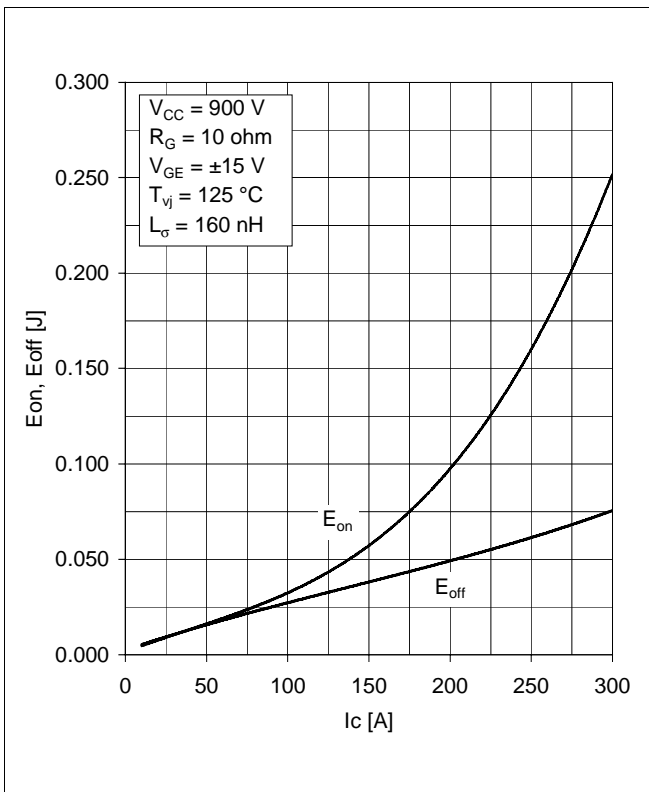

Fig. 3 Typical switching characteristics vs collector current

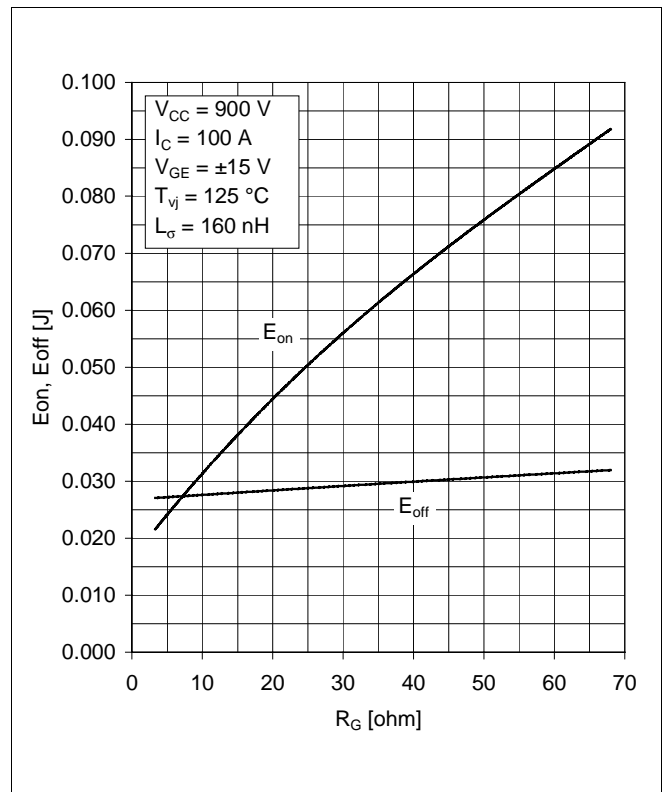

Fig. 4 Typical switching characteristics vs gate resistor

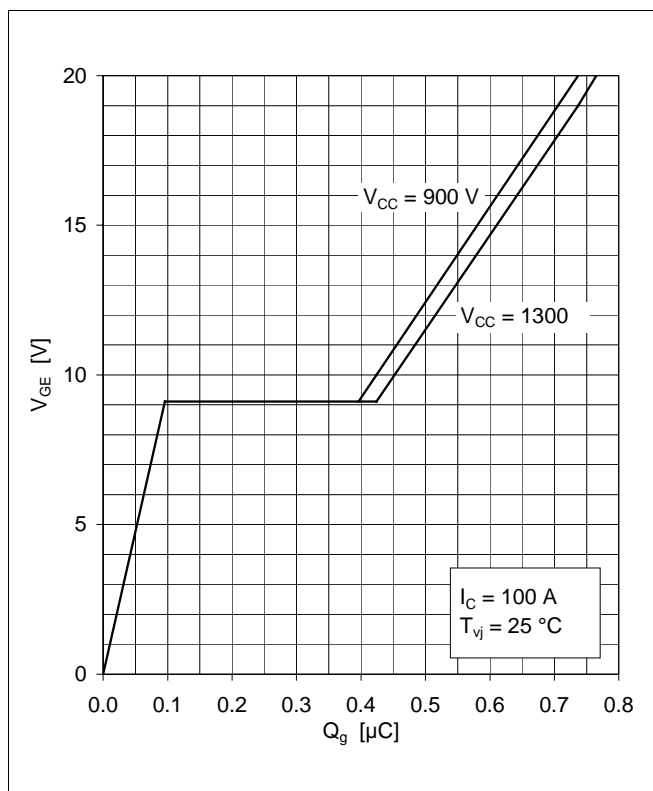

Fig. 5 Typical gate charge characteristics

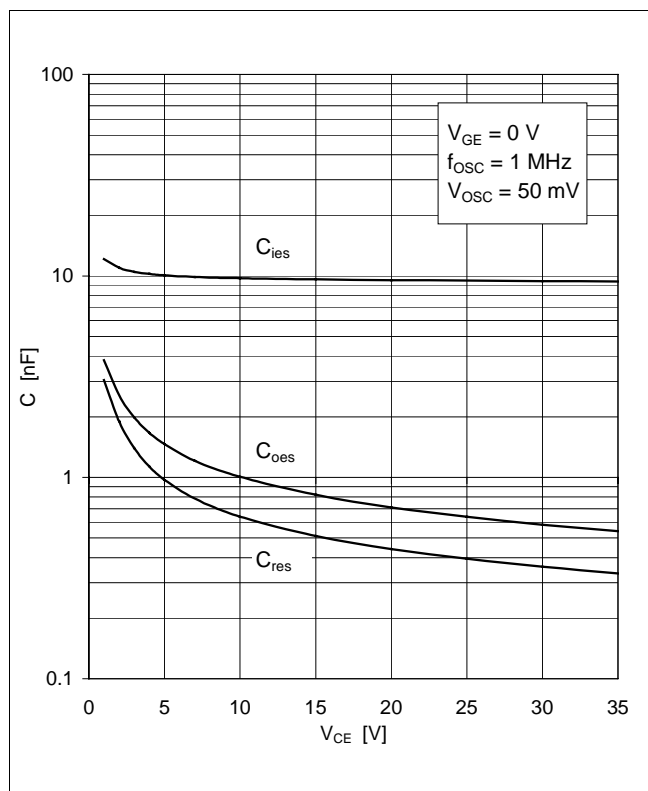

Fig. 6 Typical capacitances vs collector-emitter voltage

This technical information specifies semiconductor devices but promises no characteristics. No warranty or guarantee expressed or implied is made regarding delivery, performance or suitability.

ABB Switzerland Ltd, Semiconductors reserves the right to change specifications without notice.



ABB Switzerland Ltd
Semiconductors
 Fabrikstrasse 3
 CH-5600 Lenzburg, Switzerland

Telephone +41 (0)58 586 1419
 Fax +41 (0)58 586 1306
 Email abbsem@ch.abb.com
 Internet www.abb.com/semiconductors