

Product Specification: SP0102 Series (Generation II)

This document applies the following SiSonic Model Numbers:

SP0102NC3-2

SP0102NC3-3

SiSonic microphone was developed as a cost effective alternative to traditional electret condenser microphones. Provided on tape-and-reel, SiSonic is ideally suited for high volume applications. It can be processed directly to a customer's PCB using standard automatic pick-and-place equipment, and surface mounted via standard solder reflow equipment.

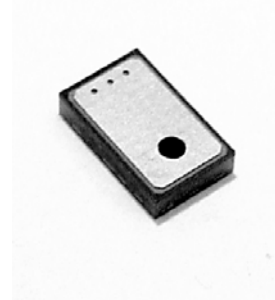

Microphone Dimensional Layout

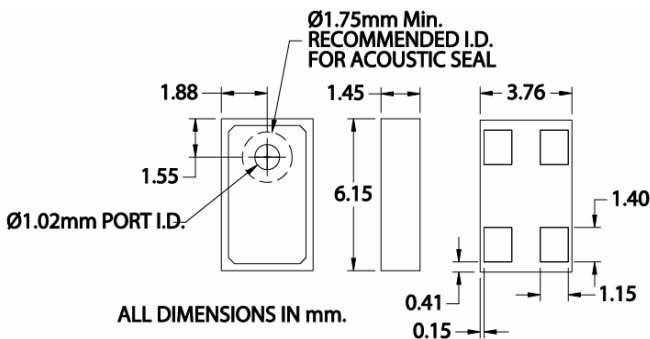

Item	Dim.	Tol. (+/-)	Units
Height	1.45	0.15	mm
Length	6.15	0.05	mm
Width	3.76	0.05	mm
Weight	< 0.5		grams
Coplanarity	< 0.1		mm

Microphone Pin Output

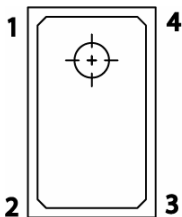

TOP VIEW

PIN#	FUNCTION
1	OUTPUT
2	NO CONNECTION
3	GROUND
4	POWER

Recommended PCB Land Layout

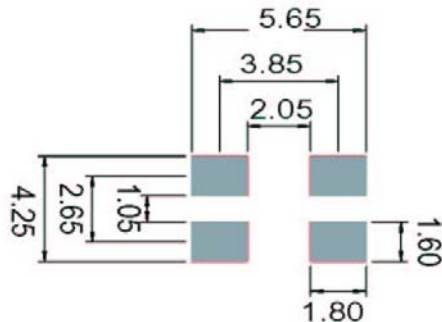

Product Specifications Test Conditions: +20°C, 60-70% R.H.

	Symbol	Condition	Limits			Unit
			Min.	Nom.	Max.	
Directivity		Omni-directional				
Sensitivity	S	@ 1kHz (0dB=1V/Pa)	-46	-42	-38	dB
Output impedance	Z _{OUT}	@ 1kHz (0dB=1V/Pa)			100	Ω
Current Consumption	I _{BSS}	across 1.5 to 5.5 volts	0.100		0.250	mA
Signal to Noise Ratio	S/N	@ 1kHz (0dB=1V/Pa)	55	59		dB
Typical Input Referred Noise	ENL	A-weighted		35		dBa SPL
Supply Voltage	Vs		1.5		5.5	V
Sensitivity Loss across Voltage		Change in sensitivity over 5.5v to 1.5v	No Change Across Voltage Range			dB
Maximum Input Sound Level		At 100dB SPL, THD < 1% At 115dB SPL, THD = < 10%				dB
Operating Temperature			-40		+100	°C
Storage Temperature			-40		+100	°C
Frequency Range		100 - 10,000				Hz

Frequency Response Curve

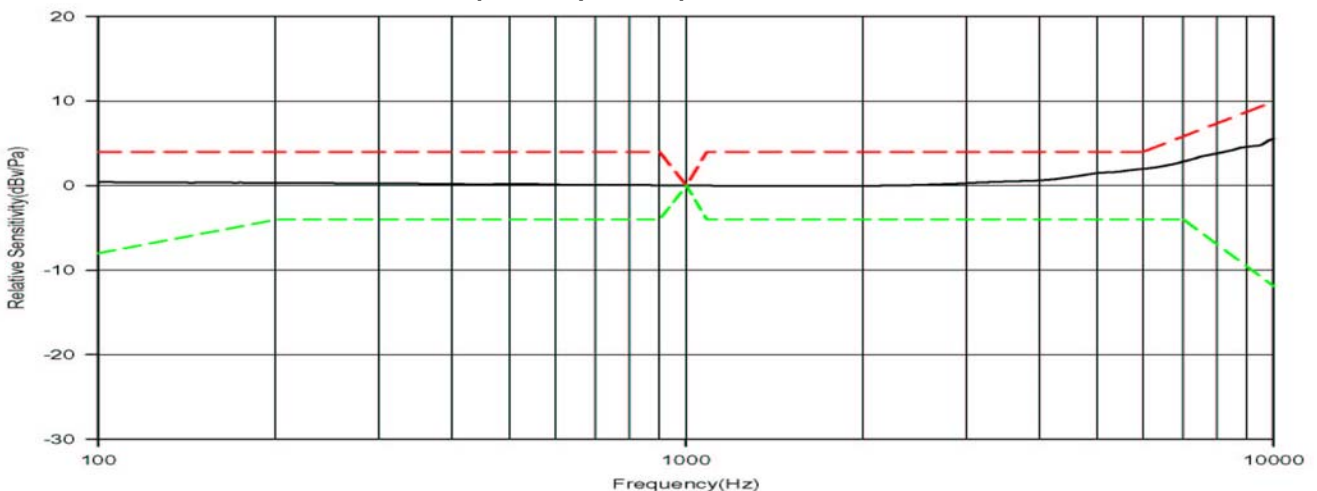

Packaging Specifications Carrier - Tape Detail

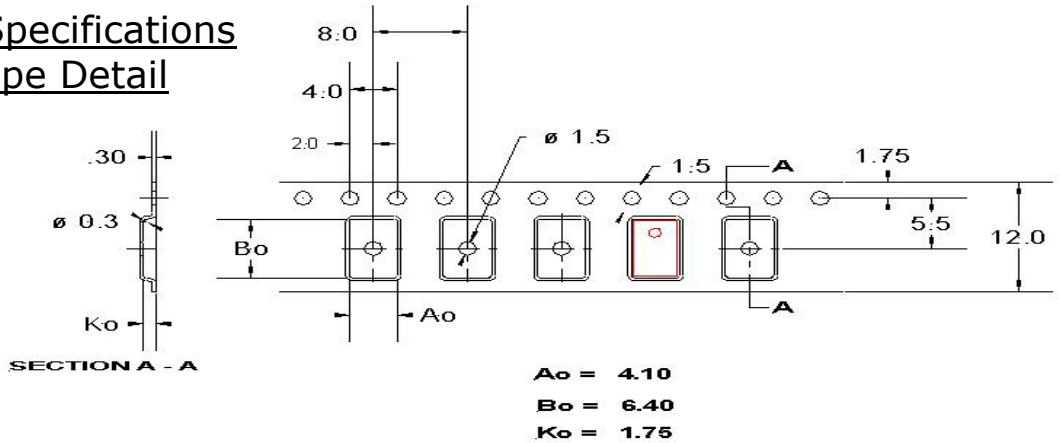

Model Number	Suffix	Reel Diameter	Qty per Reel	Capacitor Config.
SP0102NC3	-2	7"	1,200	10 & 33pF
SP0102NC3	-3	13"	4,500	10 & 33pF

NOTE: All devices are lead-free, and compatible with lead-free reflow profile.

Tape & Reel	Available in 7" or 13" diameter.
Leader Length	800mm or minimum of 100 empty pockets
Label	Label applied to external package and direct to reel. Per JEDEC.
Storage Life	1 year storage (original packaging, low humidity)
Polarity of part	"L" - direction

Solderability Characteristics (** No board washing after reflow **)

Solder Reflow	260°C for maximum 30 seconds
Terminal Pads	Gold (27u") over Nickel (150u") Typical
# of Reflow Passes	reference Reliability section

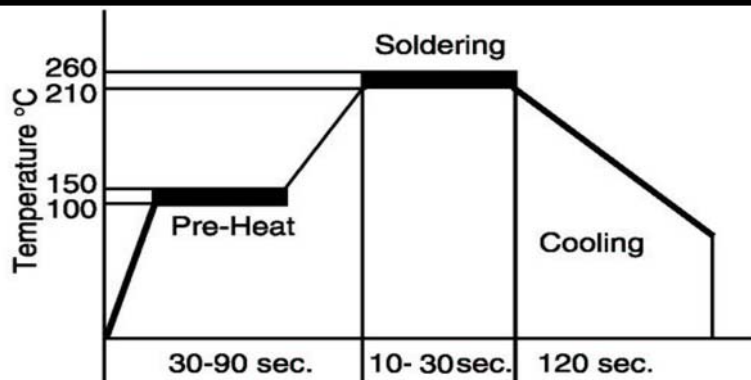
Reflow Profile
(Maximum Conditions)

Reliability

Thermal Shock	Microphone unit must operate when exposed to air-to-air thermal shock 100 cycles, from -40°C to +125°C. (IEC 68-2-4),
High Temperature Storage Test	Microphone unit must maintain sensitivity after storage at +105°C for 1,000 hours. (IEC 68-2-2 Test Ba)
Low Temperature Storage Test	Microphone unit must maintain sensitivity after storage at -40°C for 1,000 hours. (IEC 68-2-1 Test Aa)
High Temperature Operating Test	Microphone unit must operate within sensitivity specifications for 16 hours at 105°C. (IEC 68-2-2 Test Ba)
Low Temperature Operating Test	Microphone unit must operate within sensitivity specifications for 16 hours at -40°C. (IEC 68-2-1 Test Aa)
Humidity Test	Tested under Bias at 85°C/85% R.H. for 270 hours. (JESD22-A101A-B)
Vibration Test	Microphone unit must operate under test condition: 4 cycles, from 20 to 2,000 Hz in each direction (x,y,z), 48 minutes, using peak acceleration of 20g (+20%, -0%). (MIL 883E, method 2007.2, A)
Electrostatic Discharge	Tested to 8kV direct contact discharge or 15kV air discharge as specified by IEC 1000-4-2, level 3 and level 4.
Reflow	Microphone is tested to 5 passes through reflow oven, with microphone mounted upside-down under conditions of 260°C for 30 seconds maximum.
Mechanical Shock	Tested to greater than 5,000g (IEC 68-2-27, Ea).
Note:	After test conditions are performed, the sensitivity of the microphone shall not deviate more than 3dB from its initial value.

