



**HIGH DENSITY MOUNTING  
PHOTOTRANSISTOR  
OPTICALLY COUPLED ISOLATORS**

**APPROVALS**

- UL recognised, File No. E91231

**DESCRIPTION**

The TLP521, TLP521-2, TLP521-4 series of optically coupled isolators consist of infrared light emitting diodes and NPN silicon photo transistors in space efficient dual in line plastic packages.

**FEATURES**

- Options :-  
10mm lead spread - add G after part no.  
Surface mount - add SM after part no.  
Tape&reel - add SMT&R after part no.
- High Current Transfer Ratio ( 50% min)
- High Isolation Voltage (5.3kV<sub>RMS</sub>, 7.5kV<sub>PK</sub>)
- High BV<sub>CEO</sub> ( 55Vmin )
- All electrical parameters 100% tested
- Custom electrical selections available

**APPLICATIONS**

- Computer terminals
- Industrial systems controllers
- Measuring instruments
- Signal transmission between systems of different potentials and impedances

**TLP521**

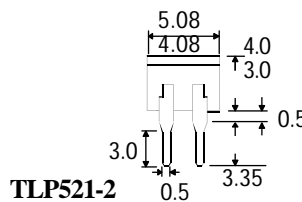
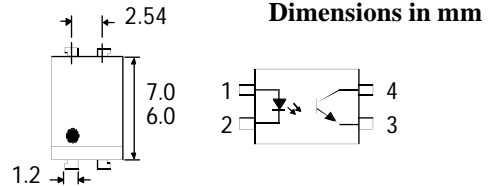

**TLP521-2**

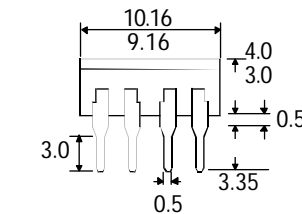
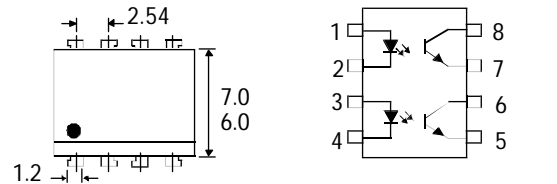

**TLP521-4**

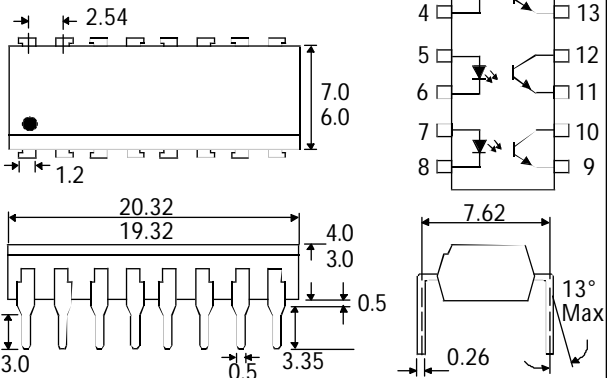

**OPTIONSM  
SURFACE MOUNT**

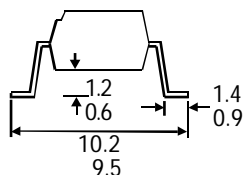

**OPTIONG**

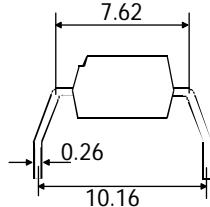

**ISOCOM COMPONENTS LTD**

Unit 25B, Park View Road West,  
Park View Industrial Estate, Brenda Road  
Hartlepool, Cleveland, TS25 1YD  
Tel: (01429) 863609 Fax :(01429) 863581

**ISOCOM INC**

720 E., Park Boulevard, Suite 104,  
Plano, TX 75074 USA  
Tel: (972) 423-5521  
Fax: (972) 422-4549

**ABSOLUTE MAXIMUM RATINGS**  
(25°C unless otherwise specified)

Storage Temperature	-55°C to + 125°C
Operating Temperature	-55°C to + 100°C
Lead Soldering Temperature	(1/16 inch (1.6mm) from case for 10 secs) 260°C

**INPUT DIODE**

Forward Current	50mA
Reverse Voltage	5V
Power Dissipation	70mW

**OUTPUT TRANSISTOR**

Collector-emitter Voltage $BV_{CEO}$	55V
Emitter-collector Voltage $BV_{ECO}$	6V
Power Dissipation	150mW

**POWER DISSIPATION**

Total Power Dissipation	200mW
(derate linearly 2.67mW/°C above 25°C)	

**ELECTRICAL CHARACTERISTICS (  $T_A = 25^\circ\text{C}$  Unless otherwise noted )**

PARAMETER		MIN	TYP	MAX	UNITS	TEST CONDITION	
Input	Forward Voltage ( $V_F$ )	1.0	1.15	1.3	V	$I_F = 10\text{mA}$ $I_R = 10\mu\text{A}$ $V_R = 5\text{V}$	
	Reverse Voltage ( $V_R$ )	5			V		
	Reverse Current ( $I_R$ )			10	$\mu\text{A}$		
Output	Collector-emitter Breakdown ( $BV_{CEO}$ ) ( Note 2 )	55			V	$I_C = 0.5\text{mA}$ $I_E = 100\mu\text{A}$ $V_{CE} = 24\text{V}$	
	Emitter-collector Breakdown ( $BV_{ECO}$ )	6			V		
	Collector-emitter Dark Current ( $I_{CEO}$ )			100	nA		
Coupled	Current Transfer Ratio (CTR) (Note 2)					$5\text{mA } I_F, 5\text{V } V_{CE}$	
	TLP521, TLP521-2, TLP521-4	50		600	%		
	CTR selection available BL	200		600	%		
	GB	100		600	%		
	GB	30				%	$1\text{mA } I_F, 0.4\text{V } V_{CE}$
	Collector-emitter Saturation Voltage $V_{CE(SAT)}$			0.4	V		
	-GB			0.4	V		
	Input to Output Isolation Voltage $V_{ISO}$	5300			$V_{RMS}$		
		7500			$V_{PK}$		
	Input-output Isolation Resistance $R_{ISO}$	$5 \times 10^{10}$			$\Omega$		
Rise Time tr		2		$\mu\text{s}$	$V_{IO} = 500\text{V}$ (note 1) $V_{CC} = 10\text{V}$ , $I_C = 2\text{mA}, R_L = 100\Omega$		
Fall Time tf		3		$\mu\text{s}$			
Turn-on Time ton		3		$\mu\text{s}$			
Turn-off Time toff		3		$\mu\text{s}$			

Note 1 Measured with input leads shorted together and output leads shorted together.

Note 2 Special Selections are available on request. Please consult the factory.

**Collector Power Dissipation vs. Ambient Temperature**

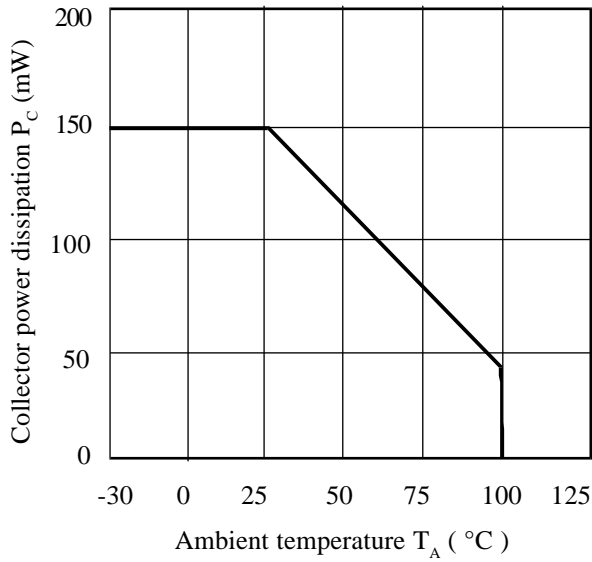

**Collector Current vs. Low Collector-emitter Voltage**

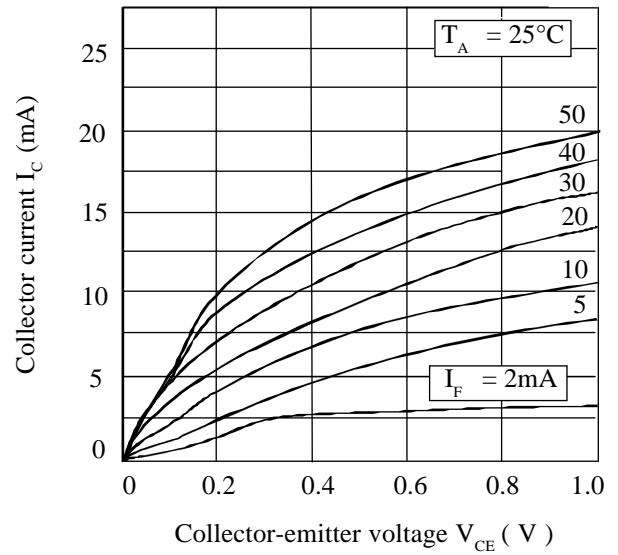

**Forward Current vs. Ambient Temperature**

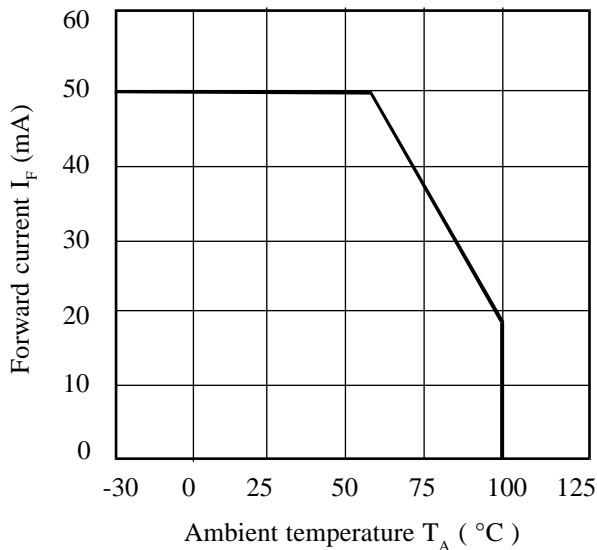

**Collector Current vs. Collector-emitter Voltage**

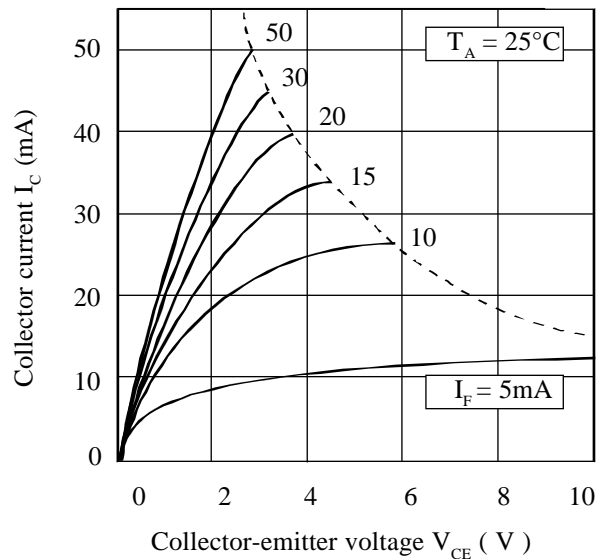

**Collector-emitter Saturation Voltage vs. Ambient Temperature**

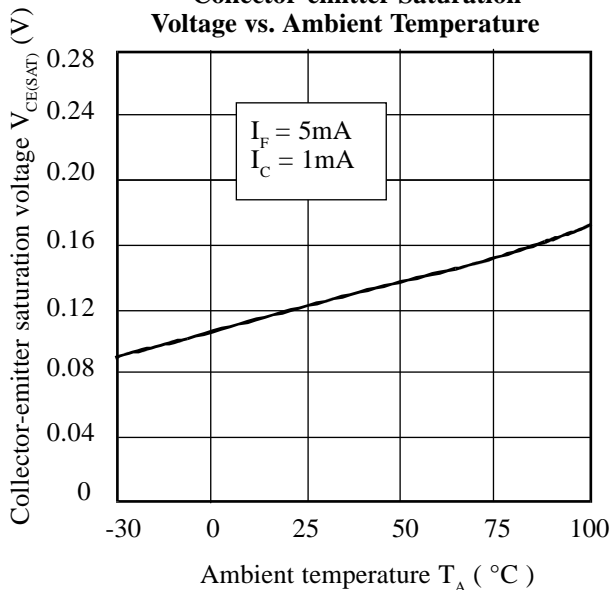

**Current Transfer Ratio vs. Forward Current**

