

Schottky Barrier Diode

B5817WS-B5819WS

FEATURES

- Extremely low V_F .
- Low stored charge, majority carrier conduction.
- Low power loss/high efficient

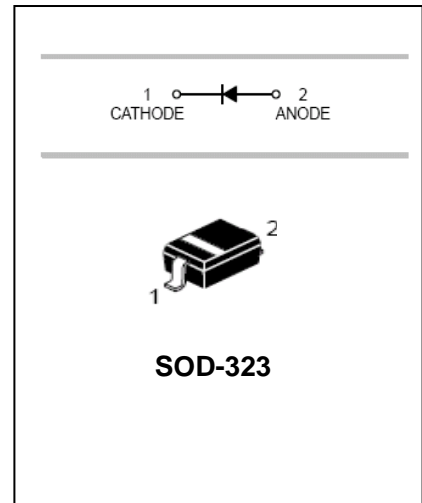

APPLICATIONS

- For Use In Low Voltage, High Frequency Inverters.
- Free Wheeling, And Polarity Protection Applications.

ORDERING INFORMATION

Type No.	Marking	Package Code
B5817WS	SJ	SOD-323
B5818WS	SK	SOD-323
B5819WS	SL	SOD-323

MAXIMUM RATING @ $T_a=25^\circ\text{C}$ unless otherwise specified

Parameter	symbol	B5817WS	B5818WS	B5819WS	Unit
Non-Repetitive Peak reverse voltage	V_{RM}	20	30	40	V
Peak repetitive Peak reverse voltage	V_{RRM}	20	30	40	V
Working Peak Reverse voltage	V_{RWM}				
DC Reverse Voltage	V_R				
RMS Reverse Voltage	$V_{R(RMS)}$	14	21	28	V
Average Rectified output Current	I_o	1			A
Peak forward surge current@=8.3ms	I_{FSM}	25			A
Repetitive Peak Forward Current	I_{FRM}	625			mA
Power Dissipation	P_d	250			mW
Thermal Resistance Junction to Ambient	$R_{\theta JA}$	500			$^\circ\text{C}/\text{W}$
Storage temperature	T_{STG}	-65~+150			$^\circ\text{C}$

Schottky Barrier Diode

B5817WS-B5819WS

ELECTRICAL CHARACTERISTICS @ Ta=25°C unless otherwise specified

Parameter	Symbol	Test Condition	MIN	MAX	UNIT
Reverse breakdown voltage	$V_{(BR)}$	$I_R=1mA$			
		B5817WS	20		V
		B5818WS	30		
		B5819WS	40		
Reverse voltage leakage current	I_R	$V_R=20V$	B5817WS		
		$V_R=30V$	B5818WS	1	mA
		$V_R=40V$	B5819WS		
Forward voltage	V_F	B5817WS	$I_F=1A$		0.45
			$I_F=3A$		0.75
		B5818WS	$I_F=1A$		0.55
			$I_F=3A$		0.875
		B5819WS	$I_F=1A$		0.6
			$I_F=3A$		0.9
Diode capacitance	C_D	$V_R=4V, f=1MHz$		120	pF

TYPICAL CHARACTERISTICS @ Ta=25°C unless otherwise specified

Fig. 1 - Forward Current Derating Curve

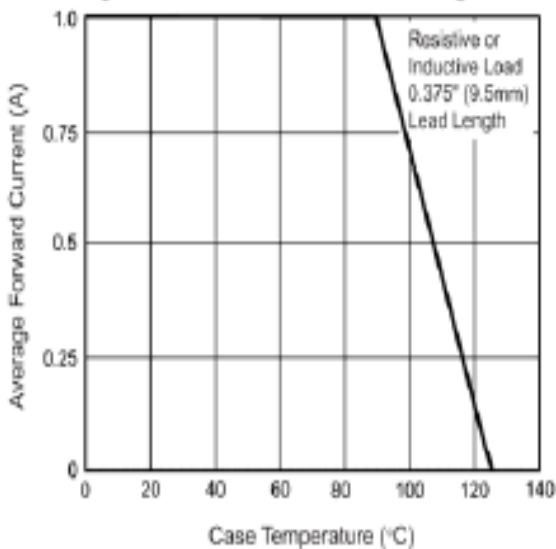
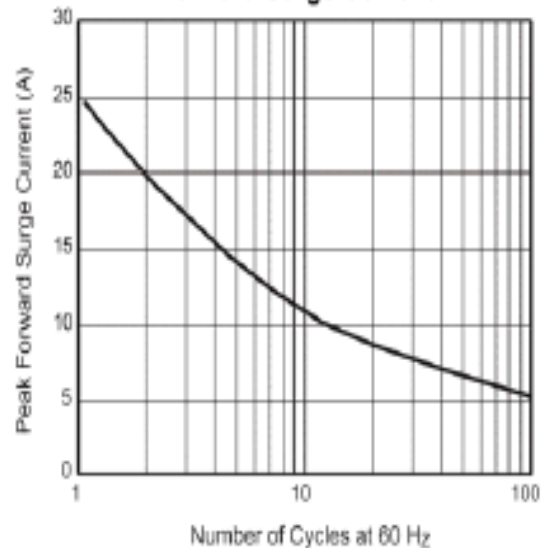

Fig. 2 - Maximum Non-Repetitive Peak Forward Surge Current



Schottky Barrier Diode

B5817WS-B5819WS

Fig. 3 - Typical Instantaneous Forward Characteristics

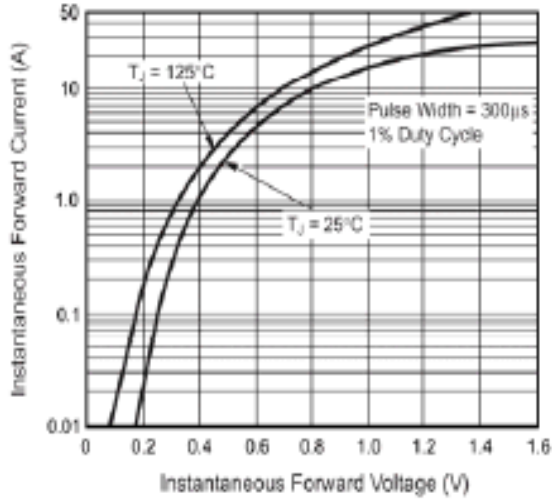

Fig. 4 - Typical Reverse Characteristics

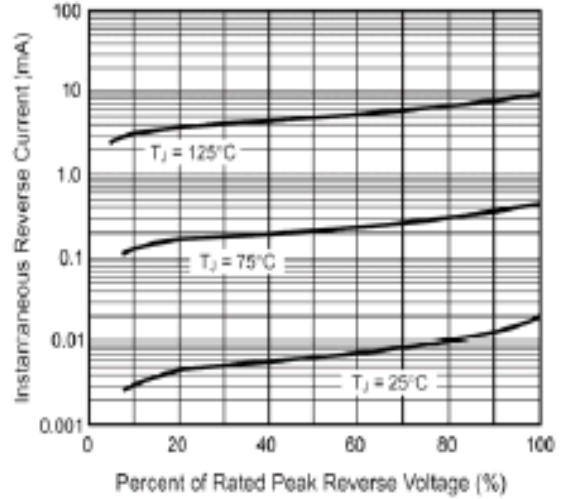

Fig. 5 - Typical Junction Capacitance

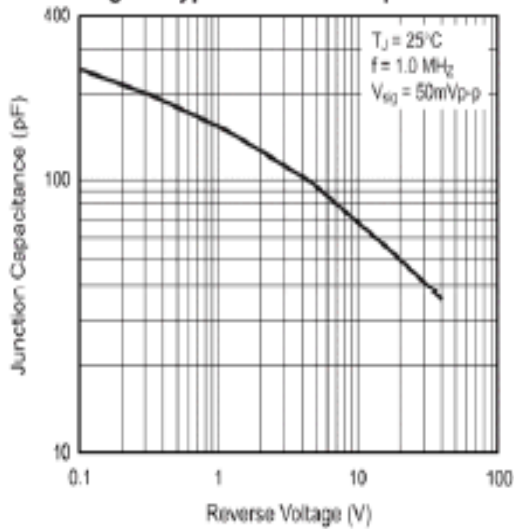
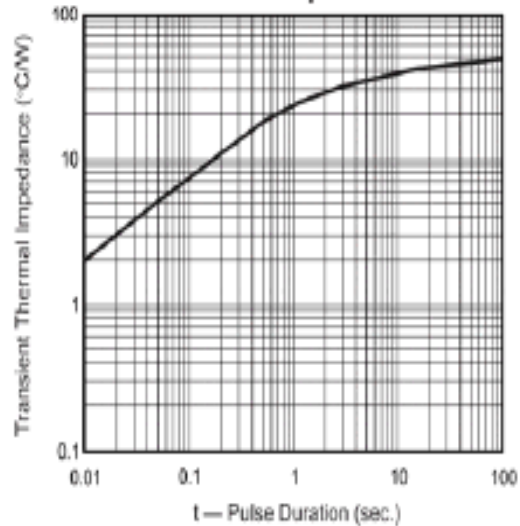

Fig. 6 - Typical Transient Thermal Impedance



Schottky Barrier Diode

B5817WS-B5819WS

PACKAGE OUTLINE

Plastic surface mounted package

SOD-323

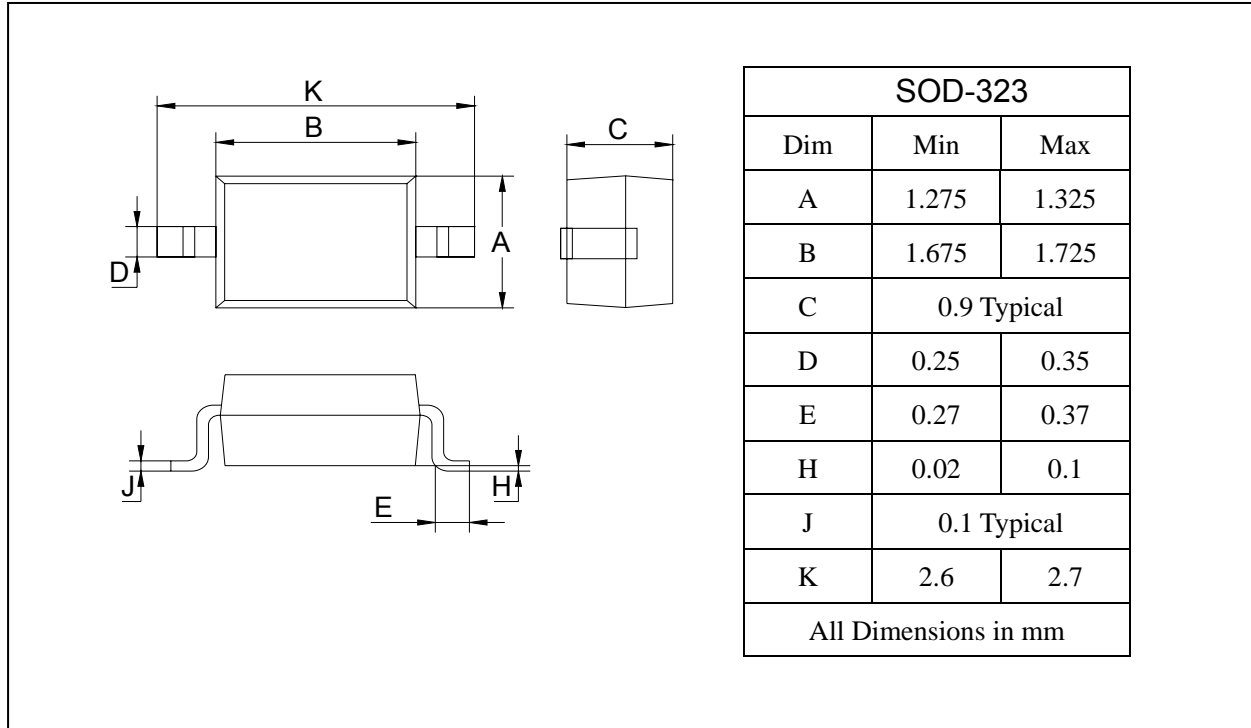

SOLDERING FOOTPRINT

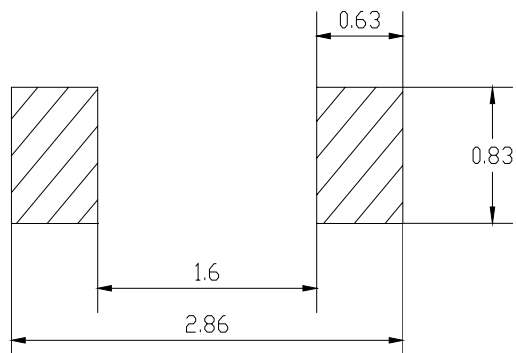

Unit : mm

PACKAGE INFORMATION

Device	Package	Shipping
B5817WS-B5819WS	SOD-323	3000/Tape&Reel