

SGM2015

Low Power, Low Dropout, 250mA, RF - Linear Regulators

GENERAL DESCRIPTION

The SGM2015 series low-power, low-noise, low-dropout, CMOS linear voltage regulators operate from a 2.5V to 5.5V input and deliver up to 250mA. They are the perfect choice for low voltage, low power applications. An ultra low ground current (160 μ A at 250mA output) makes these part attractive for battery operated power systems. The SGM2015 series also offer ultra low dropout voltage (250mV at 250mA output) to prolong battery life in portable electronics. Systems requiring a quiet voltage source, such as RF applications, will benefit from the SGM2015 series' ultra low output noise (30 μ VRMS) and high PSRR. An external noise bypass capacitor connected to the device's BP pin can further reduce the noise level.

The output voltage is preset to voltages in the range of 1.5V to 3.3V. Other features include a 10nA logic-controlled shutdown mode, foldback current limit and thermal shutdown protection.

Devices come in 5-pin SOT23 package.

FEATURES

- Low Output Noise: 30 μ VRMS typ(10Hz to 100KHz)
- Ultra-Low Dropout Voltage:
250mV at 250mA output
- Low 85 μ A No-Load Supply Current
- Low 160 μ A Operating Supply Current
at 250mA Output
- High PSRR (73dB at 1KHz)
- Thermal-Overload Protection
- Output Current Limit
- 10nA Logic-Controlled Shutdown
- Available in Multiple Output Voltage Versions
Fixed Outputs of 1.5V, 1.8V, 2.5V, 2.8V, 2.85V,
3.0V, 3.3V

APPLICATIONS

Cellular Telephones
Cordless Telephones
PHS Telephones
PCMCIA Cards
Modems
MP3 Player
Hand-Held Instruments
Palmtop Computers
Electronic Planners
Portable/Battery-Powered Equipment

PIN CONFIGURATIONS (TOP VIEW)

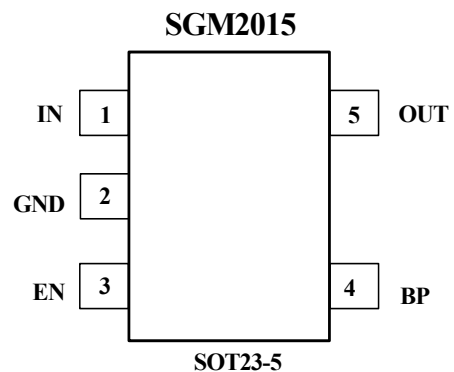

ORDERING INFORMATION

MODEL	V _{OUT} (V)	PIN-PACKAGE	SPECIFIED TEMPERATURE RANGE	ORDERING NUMBER	PACKAGE MARKING	PACKAGE OPTION
SGM2015-1.5	1.5V	SOT23-5	- 40°C to +85°C	SGM2015-1.5YN5/TR	YF15	Tape and Reel, 3000
SGM2015-1.8	1.8V	SOT23-5	- 40°C to +85°C	SGM2015-1.8YN5/TR	YF18	Tape and Reel, 3000
SGM2015-2.5	2.5V	SOT23-5	- 40°C to +85°C	SGM2015-2.5YN5/TR	YF25	Tape and Reel, 3000
SGM2015-2.8	2.8V	SOT23-5	- 40°C to +85°C	SGM2015-2.8YN5/TR	YF28	Tape and Reel, 3000
SGM2015-2.85	2.85V	SOT23-5	- 40°C to +85°C	SGM2015-2.85YN5/TR	YF2J	Tape and Reel, 3000
SGM2015-3.0	3.0V	SOT23-5	- 40°C to +85°C	SGM2015-3.0YN5/TR	YF30	Tape and Reel, 3000
SGM2015-3.3	3.3V	SOT23-5	- 40°C to +85°C	SGM2015-3.3YN5/TR	YF33	Tape and Reel, 3000

ABSOLUTE MAXIMUM RATINGS

IN to GND.....- 0.3V to +6V
 Output Short-Circuit DurationInfinite
 EN to GND.....- 0.3V to +6V
 OUT, BP/FB to GND.....- 0.3V to (V_{IN} + 0.3V)
 Power Dissipation, P_D @ T_A = 25°C
 SOT23-50.4W
 Package Thermal Resistance
 SOT23-5, θ_{JA}..... 250°C/W

Operating Temperature Range.....- 40°C to +85°C
 Junction Temperature.....+150°C
 Storage Temperature.....- 65°C to +150°C
 Lead Temperature (soldering, 10s).....260°C
 ESD Susceptibility
 HBM.....4000V
 MM.....400V

Stresses beyond those listed under “Absolute Maximum Ratings” may cause permanent damage to the device. These are stress ratings only, and functional operation of the device at these or any other conditions beyond those indicated in the operational sections of the specifications is not implied. Exposure to absolute maximum rating conditions for extended periods may affect device reliability.

ELECTRICAL CHARACTERISTICS

$V_{IN} = V_{OUT(NOMINAL)} + 1V$, $T_A = -40^{\circ}C$ to $+85^{\circ}C$, unless otherwise noted. Typical values are at $T_A = +25^{\circ}C$

PARAMETER	SYMBOL	CONDITIONS	MIN	TYP	MAX	UNITS	
Input Voltage	V_{IN}		2.5		5.5	V	
Output Voltage Accuracy		$I_{OUT} = 0.1mA$, $T_A = +25^{\circ}C$	-2		2	%	
		$I_{OUT} = 0.1mA$ to $250mA$ $T_A = -40^{\circ}C$ to $+85^{\circ}C$			2.6		
Maximum Output Current			250			mA	
Current Limit	I_{LIM}		260	450		mA	
Ground Pin Current	I_Q	No load, $EN = 1.6V$		85	135	μA	
		$I_{OUT} = 250mA$, $EN = 1.6V$		160			
Dropout Voltage(Note1)		$I_{OUT} = 1mA$		1.2		mV	
		$I_{OUT} = 250mA$		250	400		
Line Regulation	ΔV_{LNR}	$V_{IN} = 2.5V$ or $(V_{OUT} + 0.5V)$ to $5.5V$ $I_{OUT} = 1mA$		0.015	0.15	%/V	
Load Regulation	ΔV_{LDR}	$I_{OUT} = 0.1mA$ to $250mA$, $C_{OUT} = 1\mu F$		0.001	0.003	%/mA	
Output Voltage Noise	e_n	$f = 10Hz$ to $100KHz$, $C_{BP} = 0.01\mu F$, $C_{OUT} = 10\mu F$		30		$\mu VRMS$	
Power Supply Rejection Rate	PSRR	$C_{BP} = 0.1\mu F$, $I_{LOAD} = 50mA$, $C_{OUT} = 1\mu F$	$f = 100Hz$		76		dB
			$f = 1KHz$		73		dB
SHUTDOWN							
EN Input Threshold	V_{IH}	$V_{IN} = 2.5V$ to $5.5V$		1.6		V	
	V_{IL}				0.4		
EN Input Bias Current	$I_{B(SHDN)}$	$EN = 0V$ and $EN = 5.5V$	$T_A = +25^{\circ}C$		0.01	1	μA
			$T_A = +125^{\circ}C$		0.01		
Shutdown Supply Current	$I_{Q(SHDN)}$	$EN = 0.4V$	$T_A = +25^{\circ}C$		0.01	1	μA
			$T_A = +125^{\circ}C$		0.01		
Shutdown Exit Delay(Note2)		$C_{BP} = 0.01\mu F$ $C_{OUT} = 1\mu F$, No load	$T_A = +25^{\circ}C$		30	μs	
THERMAL PROTECTION							
Thermal Shutdown Temperature	T_{SHDN}			160		$^{\circ}C$	
Thermal Shutdown Hysteresis	ΔT_{SHDN}			10		$^{\circ}C$	

Specifications subject to change without notice.

Note 1: The dropout voltage is defined as $V_{IN} - V_{OUT}$, when V_{OUT} is 100mV below the value of V_{OUT} for $V_{IN} = V_{OUT} + 1V$. (Only applicable for $V_{OUT} = +2.5V$ to $+3.3V$)

Note 2: Time needed for V_{OUT} to reach 95% of final value.

TYPICAL OPERATION CIRCUIT

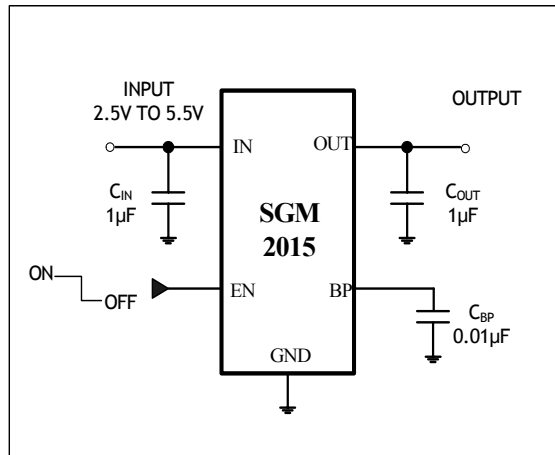

PIN DESCRIPTION

PIN	NAME	FUNCTION
1	IN	Regulator Input. Supply voltage can range from 2.5V to 5.5V. Bypass with a 1µF capacitor to GND.
2	GND	Ground.
3	EN	Shutdown Input. A logic low reduces the supply current to 10nA. Connect to IN for normal operation.
4	BP	Reference-Noise Bypass. Bypass with a low-leakage 0.01µF ceramic capacitor for reduced noise at the output.
5	OUT	Regulator Output.

TYPICAL OPERATING CHARACTERISTICS

$V_{IN} = V_{OUT(NOMINAL)} + 1V$ (whichever is greater), $C_{IN} = 1\mu F$, $C_{OUT} = 1\mu F$, $C_{BP} = 0.01\mu F$, $T_A = +25^\circ C$, unless otherwise noted.

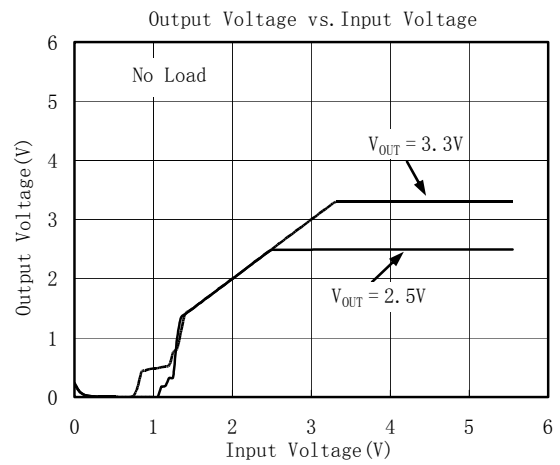
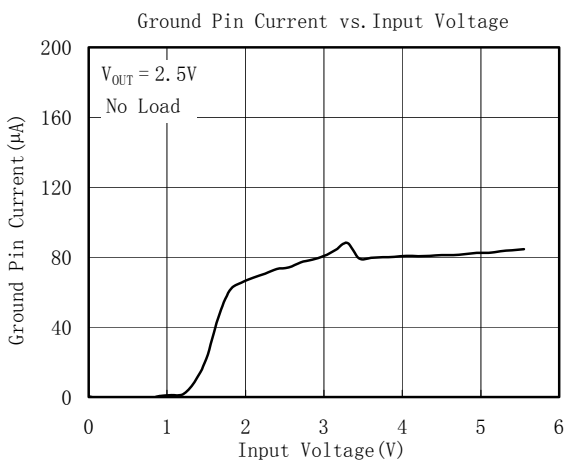
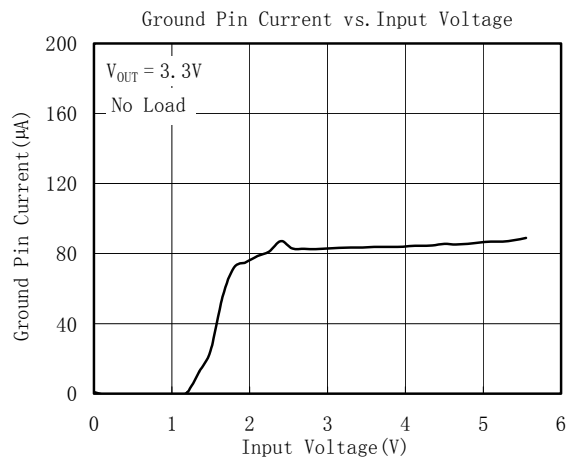
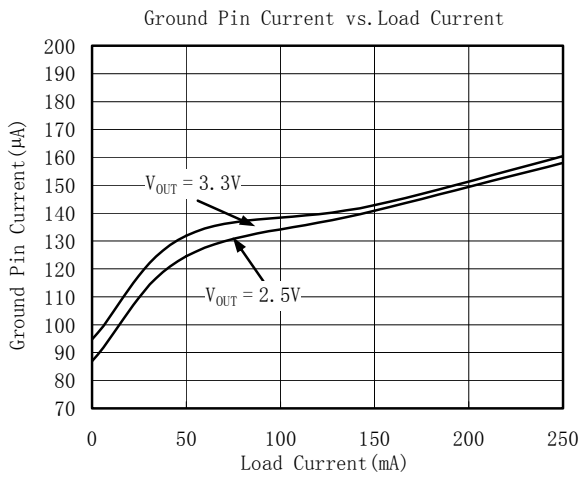
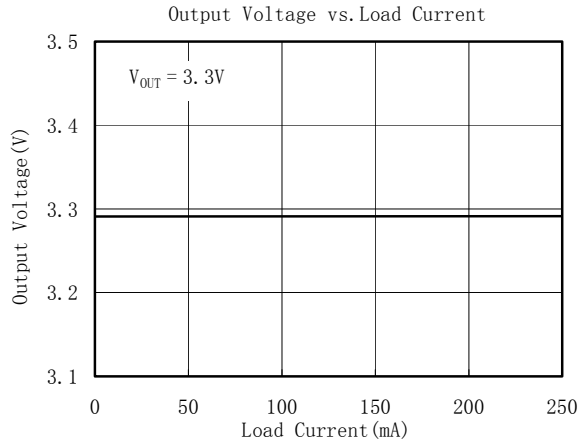
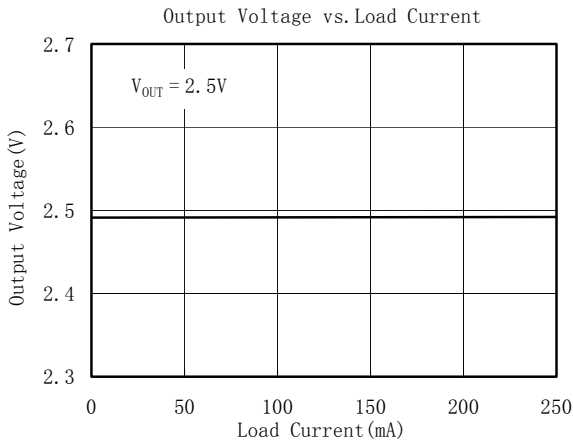

TYPICAL OPERATING CHARACTERISTICS

$V_{IN} = V_{OUT(NOMINAL)} + 1V$ (whichever is greater), $C_{IN} = 1\mu F$, $C_{OUT} = 1\mu F$, $C_{BP} = 0.01\mu F$, $T_A = +25^\circ C$, unless otherwise noted.

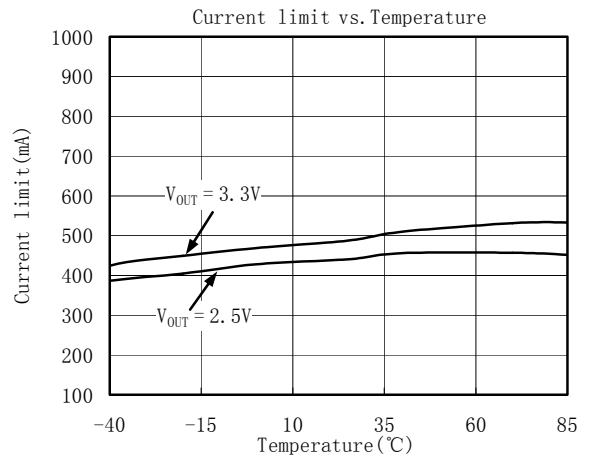
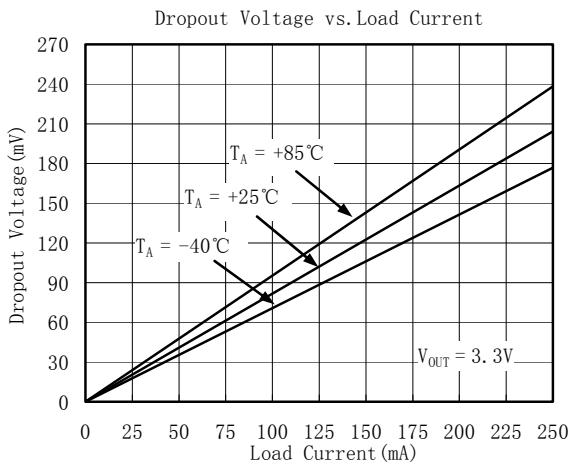
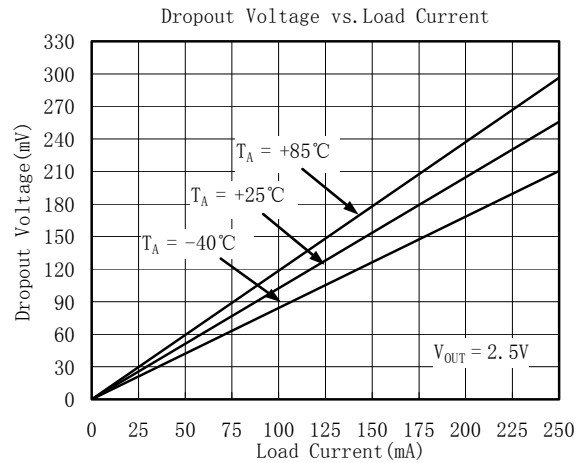
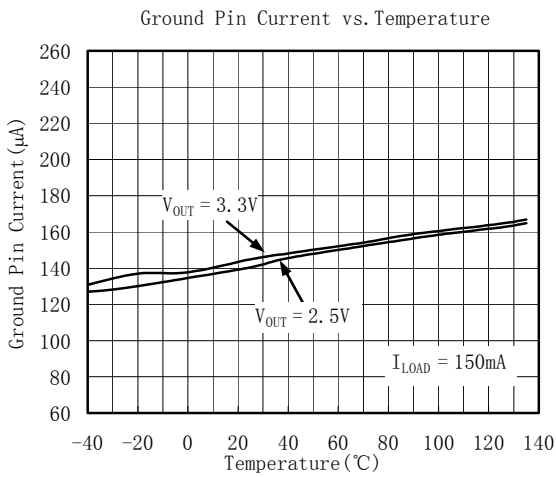
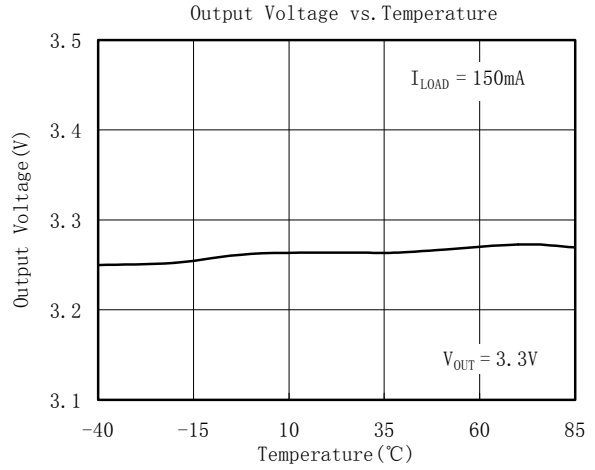
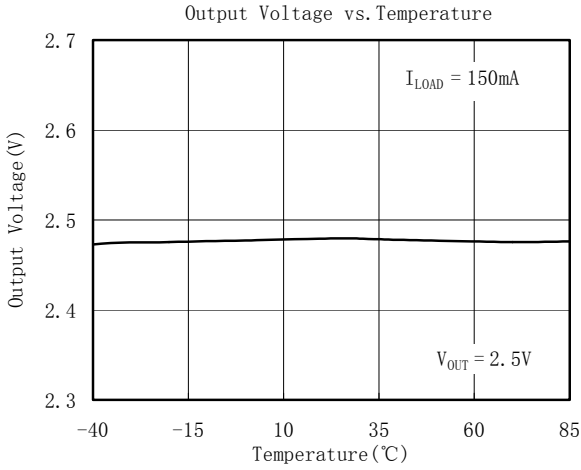

TYPICAL OPERATING CHARACTERISTICS

$V_{IN} = V_{OUT(NOMINAL)} + 1V$ (whichever is greater), $C_{IN} = 1\mu F$, $C_{OUT} = 1\mu F$, $C_{BP} = 0.01\mu F$, $T_A = +25^\circ C$, unless otherwise noted.

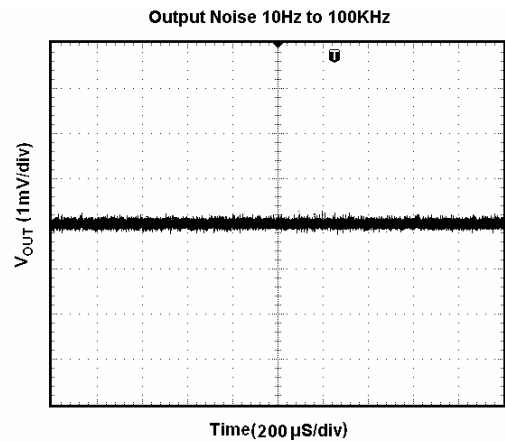
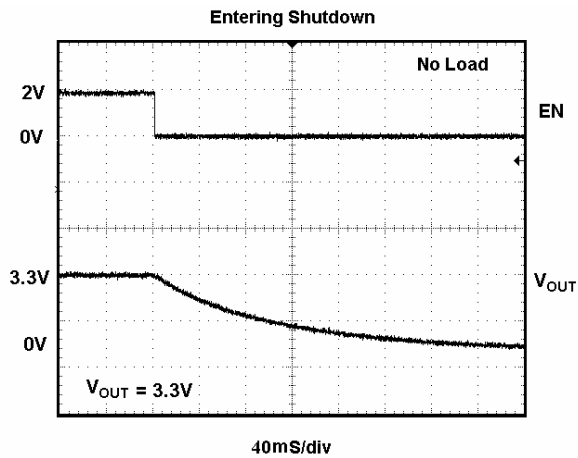
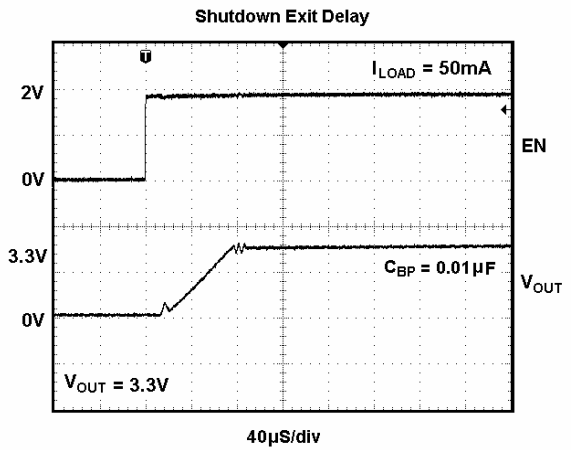
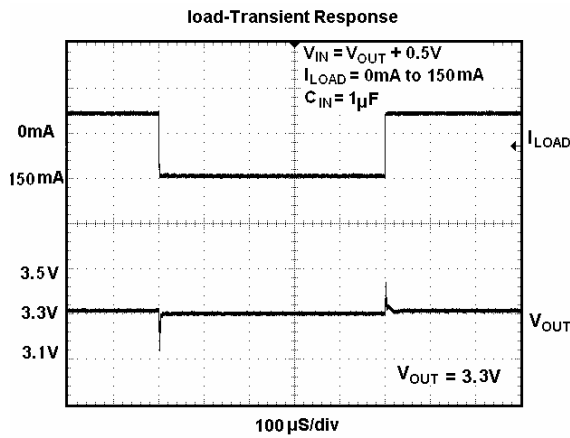
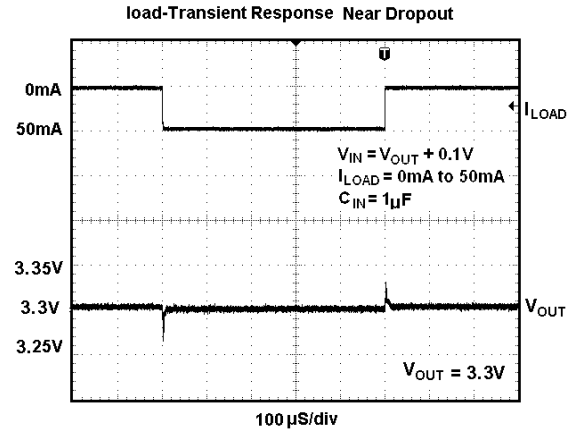
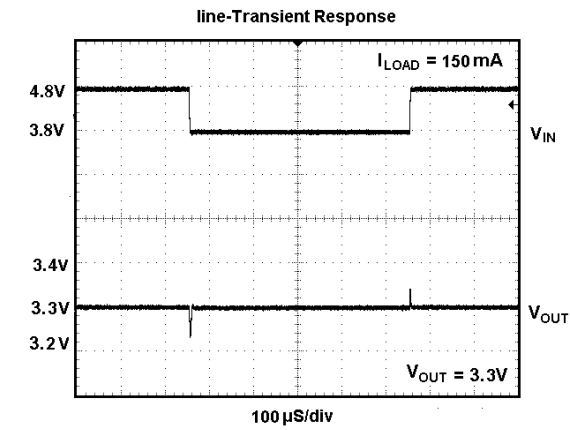

TYPICAL OPERATING CHARACTERISTICS

$V_{IN} = V_{OUT(NOMINAL)} + 1V$ (whichever is greater), $C_{IN} = 1\mu F$, $C_{OUT} = 1\mu F$, $C_{BP} = 0.01\mu F$, $T_A = +25^\circ C$, unless otherwise noted.

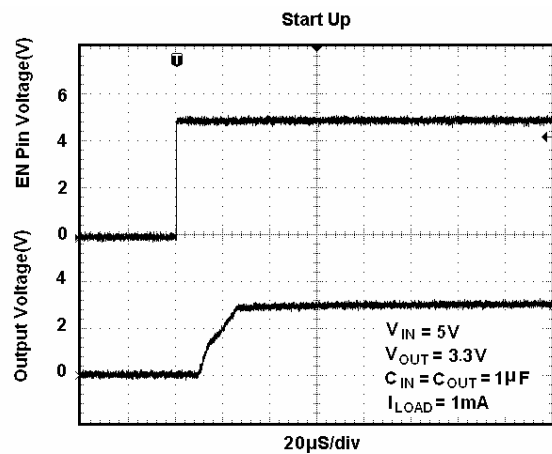
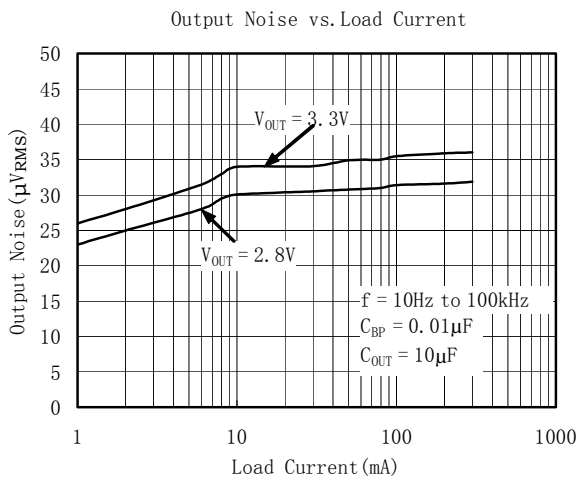
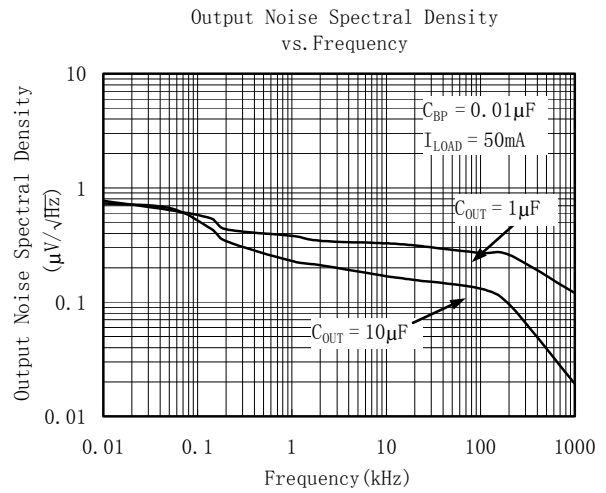
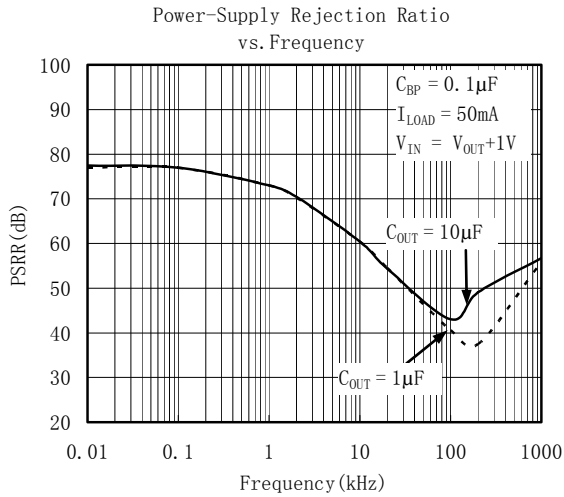

Application Notes

When LDO is used in handheld products, Attention must be paid to voltage spike which would damage SGM2015. In such applications, voltage spike will be generated at charger interface and V_{BUS} pin of USB interface when charger adapters and USB equipments are hot-inserted. Besides this, handheld products will be tested on the production line on the condition of no battery. Test Engineer will apply power from the connector pin which connects with positive pole of the battery. When external power supply is turned on suddenly, the voltage spike will be generated at the battery connector. The voltage spike will be very high, it always exceeds the absolute maximum input voltage (6.0V) of LDO. In order to get robust design. Design Engineer needs to clear up this voltage spike. Zener diode is a cheap and effective solution to eliminate such voltage spike. For example, BZM55B5V6 is a 5.6V small package Zener diode which can be used to remove voltage spike in cell phone design. The schematic is shown in below:

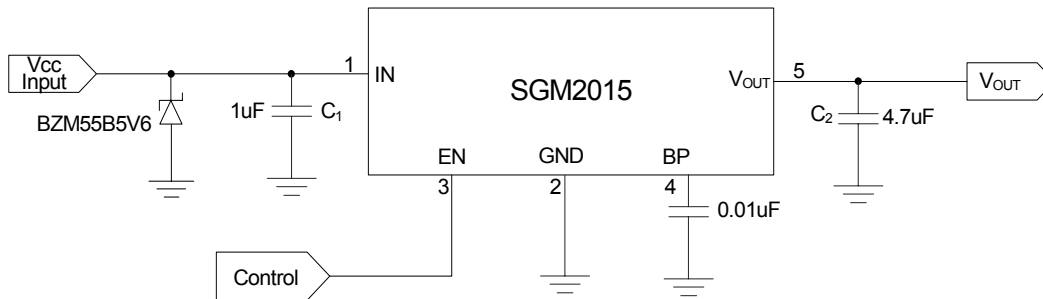

PACKAGE OUTLINE DIMENSIONS

SOT23-5

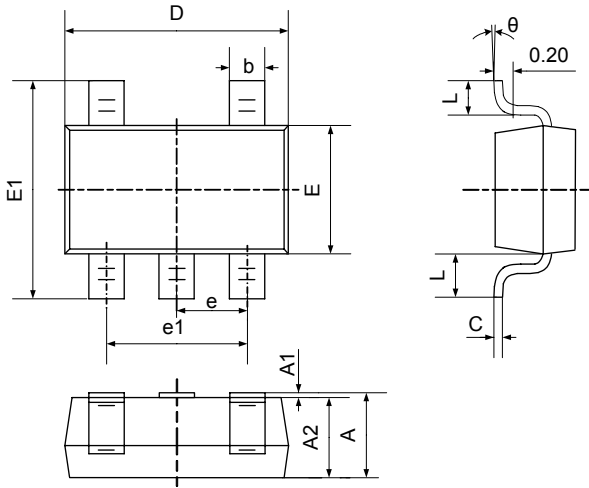

Symbol	Dimensions In Millimeters		Dimensions In Inches	
	Min	Max	Min	Max
A	1.050	1.250	0.041	0.049
A1	0.000	0.100	0.000	0.004
A2	1.050	1.150	0.041	0.045
b	0.300	0.400	0.012	0.016
c	0.100	0.200	0.004	0.008
D	2.820	3.020	0.111	0.119
E	1.500	1.700	0.059	0.067
E1	2.650	2.950	0.104	0.116
e	0.950TYP		0.037TYP	
e1	1.800	2.000	0.071	0.079
L	0.700REF		0.028REF	
L1	0.300	0.600	0.012	0.024
θ	0°	8°	0°	8°

REVISION HISTORY

Location

Page

08/07— Data Sheet REV. A

Shengbang Microelectronics Co, Ltd

Unit 3, ChuangYe Plaza
No.5, TaiHu Northern Street, YingBin Road Centralized Industrial Park
Harbin Development Zone
Harbin, HeiLongJiang 150078
P.R. China
Tel.: 86-451-84348461
Fax: 86-451-84308461
www.sg-micro.com