

Features and Benefits

- Low supply voltage
- Low current consumption
- "Active Start" (*proprietary design to address Dead Point issue*)
- High motor efficiency
- High sensitivity Hall sensor
- Full Bridge output driver
- Reverse voltage protection
- Thermal Protection
- Ultra thin leadless RoHS compliant package
- No external components

Application Examples

- BLDC vibration motors
- BLDC micro-motors
- Mobile phones
- Pagers
- Game consoles (force feedback devices)
- Other portable devices

Ordering Information

Part No.
MLX90283

Temperature Code
E (-40°C to 85°C)

Package Code
LD (UTQFN 6L)

1 Functional Diagram

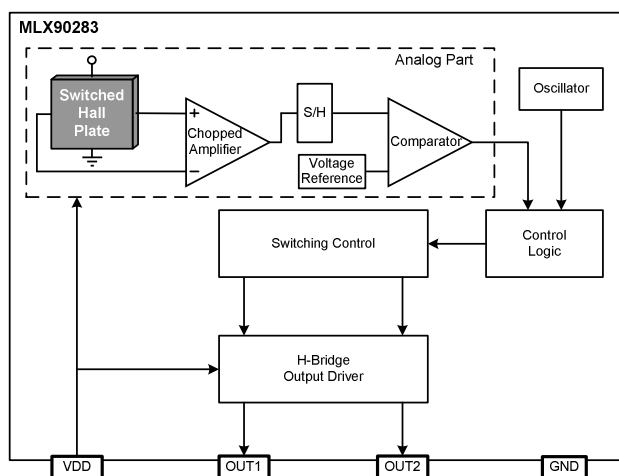

2 General Description

The MLX90283 is a one-chip solution for driving single-coil brushless DC vibration motors.

Designed in mixed signal CMOS technology, the device integrates Hall sensor with dynamic offset cancellation, control logic and full bridge output driver.

Targeting vibration motor application requirements, Melexis innovates by introducing the new "Active Start" function that improves motor start-up reliability.

The device is delivered in an Ultra Thin QFN package. Its 0.4mm thickness enables thin and competitive vibration motor design.

This 6-pin leadless package is RoHS compliant.

Table of Contents

1 Functional Diagram	1
2 General Description	1
3 Glossary of Terms	3
4 Absolute Maximum Ratings	3
5 Pin Definitions and Descriptions	3
6 General Electrical Specifications	4
7 Magnetic Characteristics	4
8 Output Behaviour versus Magnetic Pole	4
9 Detailed General Description	5
10 Unique Features	5
11 Performance Graphs	6
11.1 Magnetic parameters vs. T_J	6
11.2 Magnetic parameters vs. V_{DD}	6
11.3 $R_{DS(ON)}$ vs. T_J	6
11.4 $R_{DS(ON)}$ vs. V_{DD}	6
11.5 I_{DD} vs. T_J	6
11.6 I_{DD} vs. V_{DD}	6
11.7 T_{FW} vs. T_J	7
11.8 T_{FW} vs. V_{DD}	7
12 Application Information	7
13 Application Comments	7
14 Standard information regarding manufacturability of Melexis products with different soldering processes	8
15 ESD Precautions	8
16 LD Package Information	9
17 Disclaimer	10

3 Glossary of Terms

BLDC	Brush-Less Direct Current
Full Bridge (H-Bridge)	Two push-pull output drivers enabling bidirectional current flow through the connected load
MilliTesla (mT), Gauss	Units of magnetic flux density: 1mT = 10 Gauss
Freewheel	Period of time while the rotor continues spinning after disengagement from the drive mechanism, i.e. after switching off the coil output drivers in a BLDC motor.
Dead Point	Rotor angular position where the motor torque is zero

4 Absolute Maximum Ratings

Parameter	Symbol	Value	Units	
Supply Voltage	V _{DD}	-5 to 5	V	
Continuous Output Current ⁽¹⁾	I _{OUT}	150	mA	
Peak Output Current	I _{OUTP}	250	mA	
Magnetic Flux Density	B	Unlimited	mT	
Operating Temperature Range	T _A	-40 to 85	°C	
Storage Temperature Range	T _S	-65 to 150	°C	
Junction Temperature	T _J	125	°C	
Power dissipation	Single-layer (1S0P) PCB	P _D	500	mW
	Multi-layer (1S2P) PCB	P _D	1600	mW
ESD Sensitivity ⁽²⁾	-	4000	V	

Table 1: Absolute maximum ratings

Note 1: Value of continuous output current using recommended land pattern – Exposed pad connected to PCB substrate with solder

Note 2: Human Body Model according JESD22-A114 standard – 100pF capacitor discharged through 1.5kΩ resistor into each pin.

Exceeding the absolute maximum ratings may cause permanent damage. Exposure to absolute-maximum-rated conditions for extended periods may affect device reliability.

5 Pin Definitions and Descriptions

Pin №	Pin Name	Function
1	VDD	Power Supply
2	NC	Not Connected
3	OUT1	Coil Driver 1
4	GND	Ground
5	OUT2	Coil Driver 2
6	NC	Not Connected

Table 2: Pin definitions and descriptions

Note : Exposed Pad connected to ground

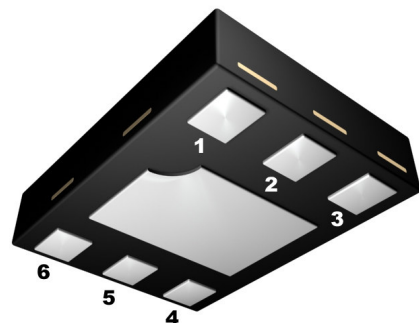

6 General Electrical Specifications

DC Operating Parameters $T_J = 25^\circ\text{C}$, $V_{DD} = 3\text{V}$ (unless otherwise specified)

Parameter	Symbol	Test Conditions	Min	Typ	Max	Units
Supply Voltage	V_{DD}	Operating	1.8	3	3.6	V
Supply Current	I_{DD}	No load between OUT1/OUT2		2.1	3.2	mA
Output ON Resistance (Full Bridge)	R_{ON}	$T_J = 25^\circ\text{C}$		2.3	4	Ω
		$T_J = 85^\circ\text{C}$		2.7	5	Ω
“Active Start” Detection Period	T_{ON}	Fixed magnetic field direction	75	150	170	ms
“Active Start” Frequency	F_{AS}	See Note 3	8	13	20	Hz
“Active Start” Duty Cycle	D_{AS}	See Note 4		87.5		%
Freewheel Delay	T_{FW}		60	92	140	μs
Sensing Propagation Delay	T_{SENSE}	See Note 5		36		μs
Thermal Protection Shutdown	T_{SD}	See Note 6		170		$^\circ\text{C}$
Thermal Protection Release	T_{REL}	See Note 6		160		$^\circ\text{C}$
Package Thermal Resistance	R_{THj-a}	Single layer (1S0P) PCB		250		$^\circ\text{C/W}$
		Multi-layer (1S2P) PCB		78		

Table 3: Electrical specifications

Note 3: The Active Start Frequency is determined as follow:

$$F_{AS} = \frac{1}{T_{AS_FW} + T_{AS_RV}}$$

Where:

T_{AS_FW} is the Active Start forward driving duration

T_{AS_RV} is the Active Start reverse driving duration

Note 4: The Active Start Duty Cycle represents the percentage of forward driving compared to the total Active Start period:

$$D_{AS(\%)} = \frac{T_{AS_FW}}{T_{AS_FW} + T_{AS_RV}}$$

Where:

T_{AS_FW} is the Active Start forward driving duration

T_{AS_RV} is the Active Start reverse driving duration

Note 5: The sensing propagation delay represents the delay from the magnetic field change ($B > B_{OP}$ or $B < B_{RP}$) to the beginning of the output change.

Note 6: Guaranteed by design

7 Magnetic Characteristics

DC Operating Parameters $T_J = 25^\circ\text{C}$, $V_{DD} = 3\text{V}$ (unless otherwise specified)

Parameter	Symbol	Min	Typ	Max	Units
Operate point	B_{OP}	0	2	5	mT
Release point	B_{RP}	-5	-2	0	mT
Hysteresis	B_{HYST}	1	4	8	mT

Table 4: Magnetic specifications

8 Output Behaviour versus Magnetic Pole

Parameter	Test conditions	OUT1	OUT2
South pole	$B > B_{OP}$	High	Low
North pole	$B < B_{RP}$	Low	High

Table 5: Output behaviour versus magnetic pole

Note : The magnetic pole is applied facing the branded side of the package



9 Detailed General Description

The MLX90283 is a complete one-chip solution for driving BLDC vibration motors. As a result of the low output resistance of the full bridge output and the low supply current, the IC provides high driving performance and increased motor efficiency. The built-in reverse voltage protection avoids any damage in case the supply voltage is accidentally reversed.

The UTQFN package requires only 3mm² PCB surface. The 0.4mm thickness enables production of very small and thin vibration motors.

The package also includes an Exposed Pad for enhanced thermal performance.

10 Unique Features

The new proprietary design from Melexis “Active Start” provides an appropriate solution against the major source of vibration motor start-up reliability issue: rotor stalled close to the dead point. When the rotor position is close to the dead point the force produced by the stator is not sufficient to overcome the mechanical friction. The rotor is stalled and cannot start rotating without an additional external force.

The “Active Start” function is activated if the magnetic pole sensed by the device does not change for more than 110ms typical. In this mode the device effectively decreases the mechanical friction by applying a special shaking signal to the motor coil which helps to overcome the dead point position. The function is immediately deactivated after a change in the magnetic pole sensed by the device.

A BLDC vibration motor is designed and optimised for one rotation direction (clockwise or counter-clockwise). Rotating in the reverse direction inevitably leads to a reduction of the motor performance as loss in revolution per minute and higher current consumption.

The Active Start favours the normal rotation direction to always ensure the highest motor performance.

Vibration motors are predominantly used in battery-powered applications. Low power consumption is a critical characteristic to ensure longer operation time.

Based on the “Freewheel” principle, the MLX90283 features a special motor driving technique to lower the motor current consumption. With optimized position of the Hall sensor in the vibration motor, the Freewheel event occurs only when the motor torque is low. Cutting this part of the motor torque does not affect the rotation speed while the motor current consumption is reduced proportionally to the rotation speed. This simple and efficient system directly improves the motor efficiency.

The Freewheel principle enables to reach high rotation speed with lower power consumption than usual.

11 Performance Graphs

11.1 Magnetic parameters vs. T_J

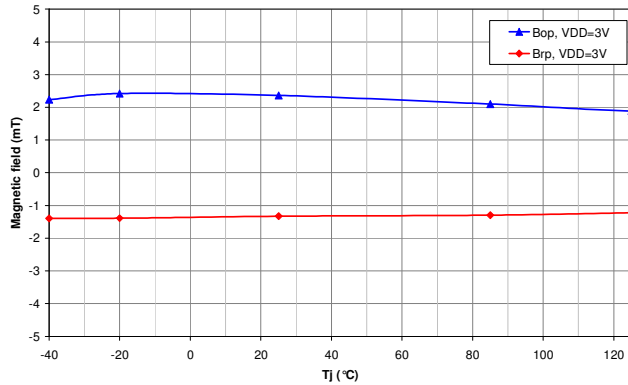

11.2 Magnetic parameters vs. V_{DD}

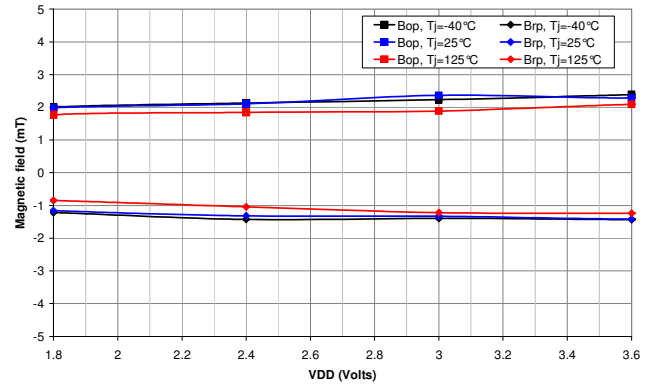

11.3 $R_{DS(on)}$ vs. T_J

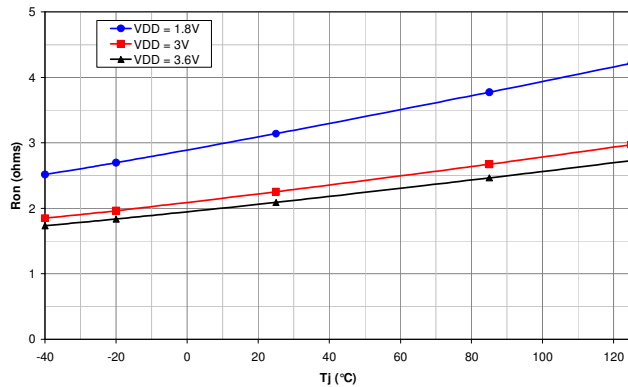

11.4 $R_{DS(on)}$ vs. V_{DD}

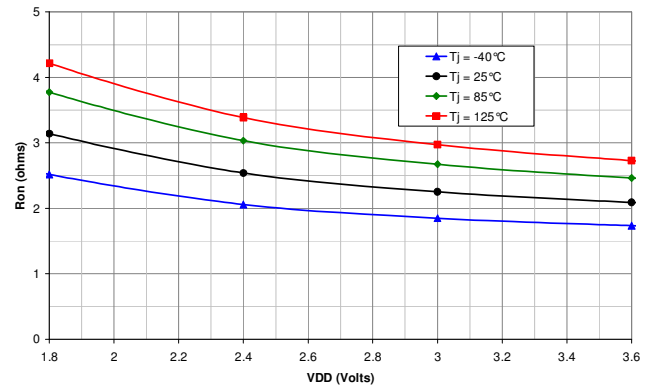

11.5 I_{DD} vs. T_J

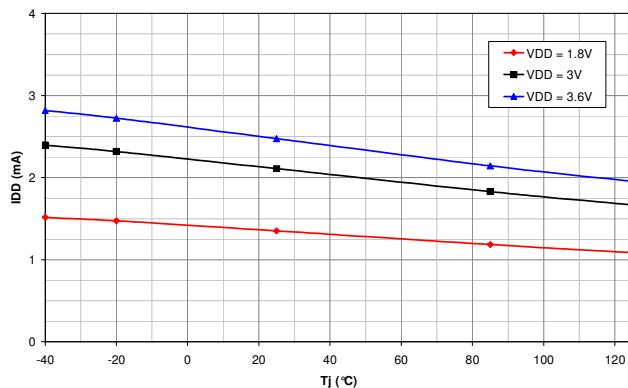

11.6 I_{DD} vs. V_{DD}

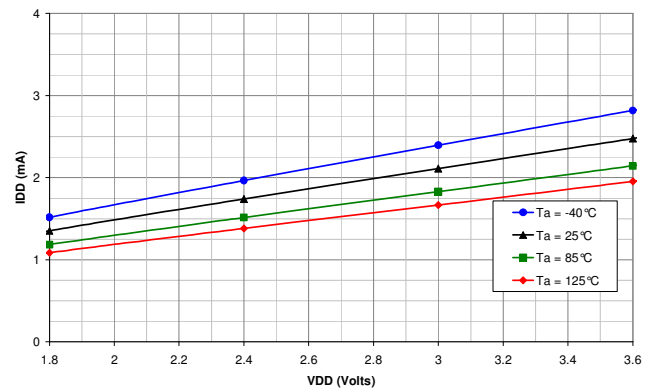

11.7 T_{FW} vs. T_J

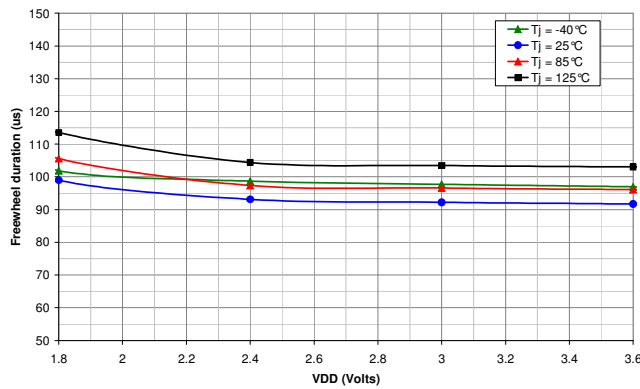

11.8 T_{FW} vs. V_{DD}

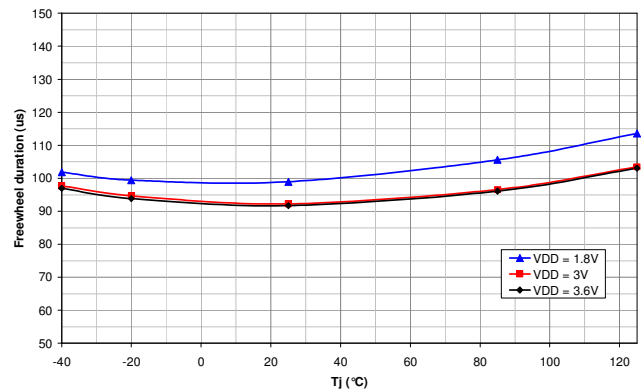

12 Application Information

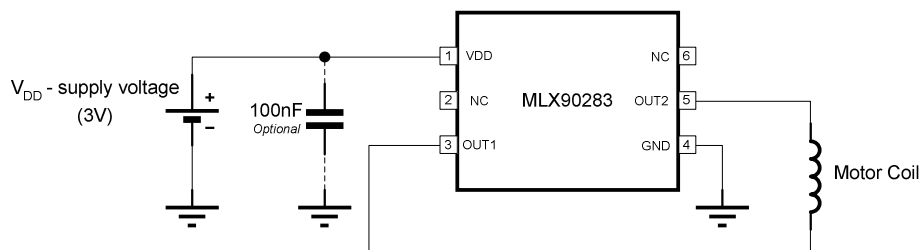

13 Application Comments

For proper operation, the power supply should be decoupled by a 22nF ~ 100nF capacitor.

In order to protect the device against over voltages spikes on the V_{DD} line, a zener diode with $V_Z < 5\text{V}$ should be connected between V_{DD} and ground, thus limiting the spikes below the absolute maximum rating.

14 Standard information regarding manufacturability of Melexis products with different soldering processes

Our products are classified and qualified regarding soldering technology, solderability and moisture sensitivity level according to following test methods:

Reflow Soldering SMD's (Surface Mount Devices)

- IPC/JEDEC J-STD-020
Moisture/Reflow Sensitivity Classification for Nonhermetic Solid State Surface Mount Devices (classification reflow profiles according to table 5-2)
- EIA/JEDEC JESD22-A113
Preconditioning of Nonhermetic Surface Mount Devices Prior to Reliability Testing (reflow profiles according to table 2)

Wave Soldering SMD's (Surface Mount Devices) and THD's (Through Hole Devices)

- EN60749-20
Resistance of plastic- encapsulated SMD's to combined effect of moisture and soldering heat
- EIA/JEDEC JESD22-B106 and EN60749-15
Resistance to soldering temperature for through-hole mounted devices

Iron Soldering THD's (Through Hole Devices)

- EN60749-15
Resistance to soldering temperature for through-hole mounted devices

Solderability SMD's (Surface Mount Devices) and THD's (Through Hole Devices)

- EIA/JEDEC JESD22-B102 and EN60749-21
Solderability

For all soldering technologies deviating from above mentioned standard conditions (regarding peak temperature, temperature gradient, temperature profile etc) additional classification and qualification tests have to be agreed upon with Melexis.

The application of Wave Soldering for SMD's is allowed only after consulting Melexis regarding assurance of adhesive strength between device and board.

Melexis is contributing to global environmental conservation by promoting **lead free** solutions. For more information on qualifications of **RoHS** compliant products (RoHS = European directive on the Restriction Of the use of certain Hazardous Substances) please visit the quality page on our website:
<http://www.melexis.com/quality.aspx>

15 ESD Precautions

Electronic semiconductor products are sensitive to Electro Static Discharge (ESD). Always observe Electro Static Discharge control procedures whenever handling semiconductor products.

16 LD Package Information

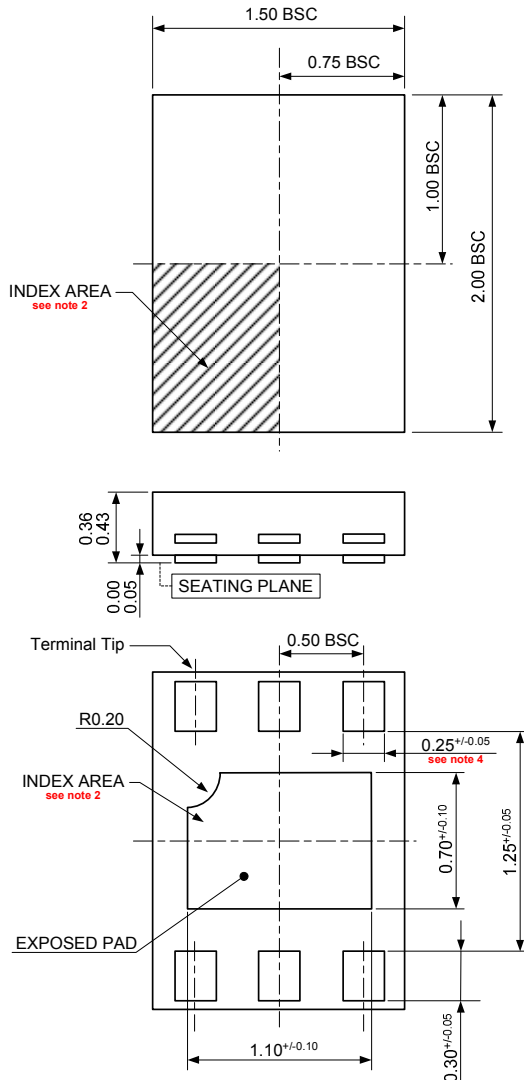

Notes:

- All dimensions are in millimeters.
- The terminal #1 identifier and terminal numbering convention shall conform JEDEC publication 95 SPP-002. Details of terminal #1 identifier are optional, but must be located within the zone indicated. The terminal #1 identifier may be marked feature.
- Depopulation is possible in a symmetrical fashion.
- Pad length applies to metallized terminal and is measured between 0.15mm and 0.30mm from the terminal tip. If the terminal has the optional radius on the other end of the terminal, the pad length should not be measured in that radius area.

Marking:

- 1st Line : .83
 ". " (dot) - used to show the 1st pin
 83 - Name of the device (MLX90283)
- 2nd Line : YWW
 Y - Year (last digit)
 WW - Calendar Week

Hall plate location

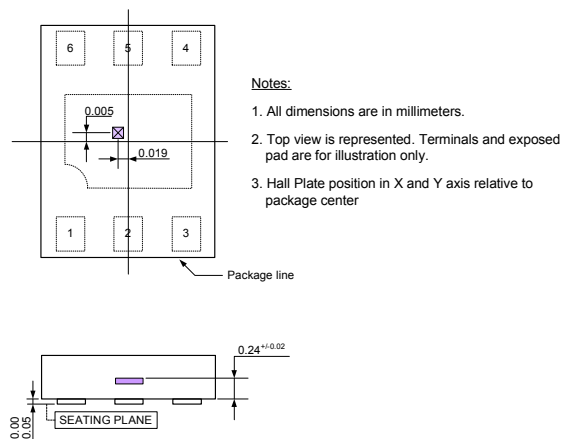

Land Pattern

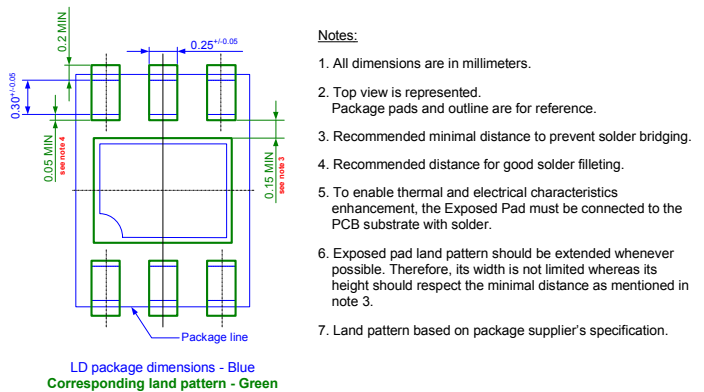

17 Disclaimer

Devices sold by Melexis are covered by the warranty and patent indemnification provisions appearing in its Term of Sale. Melexis makes no warranty, express, statutory, implied, or by description regarding the information set forth herein or regarding the freedom of the described devices from patent infringement. Melexis reserves the right to change specifications and prices at any time and without notice. Therefore, prior to designing this product into a system, it is necessary to check with Melexis for current information. This product is intended for use in normal commercial applications. Applications requiring extended temperature range, unusual environmental requirements, or high reliability applications, such as military, medical life-support or life-sustaining equipment are specifically not recommended without additional processing by Melexis for each application.

The information furnished by Melexis is believed to be correct and accurate. However, Melexis shall not be liable to recipient or any third party for any damages, including but not limited to personal injury, property damage, loss of profits, loss of use, interrupt of business or indirect, special incidental or consequential damages, of any kind, in connection with or arising out of the furnishing, performance or use of the technical data herein. No obligation or liability to recipient or any third party shall arise or flow out of Melexis' rendering of technical or other services.

© 2005 Melexis NV. All rights reserved.

For the latest version of this document, go to our website at
www.melexis.com

Or for additional information contact Melexis Direct:

Europe, Africa, Asia:
Phone: +32 1367 0495
E-mail: sales_europe@melexis.com

America:
Phone: +1 603 223 2362
E-mail: sales_usa@melexis.com

ISO/TS 16949 and ISO14001 Certified