



Ku-Band MMIC VCO with DIVIDE-BY-8, 14.0 - 15.0 GHz

Typical Applications

Low noise MMIC VCO w/Divide-by-8 for Ku-Band applications such as:

- Point-to-Point Radios
- Point-to-Multi-Point Radios / LMDS
- VSAT

Features

- Pout: +7 dBm
- Phase Noise: -105 dBc/Hz @100 KHz Typ.
- No External Resonator Needed
- Single Supply: 5V @ 325 mA
- QSOP16G SMT Package

Functional Diagram

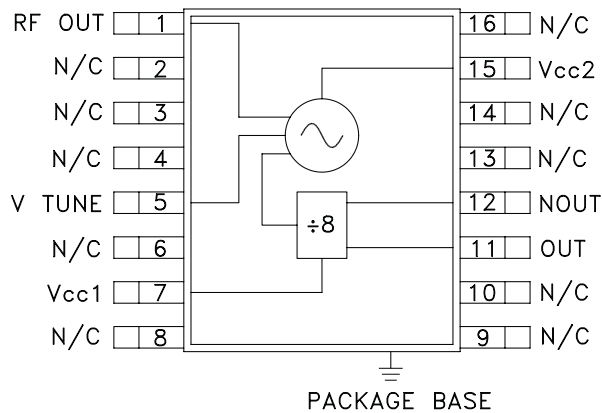

General Description

The HMC398QS16G & HMC398QS16GE are single chip GaAs InGaP Heterojunction Bipolar Transistor (HBT) MMIC VCOs. The HMC398QS16G & HMC398QS16GE integrate resonators, negative resistance devices, varactor diodes and divide-by-8 prescalers. The VCO's phase noise performance is excellent over temperature, shock, and process due to the oscillator's monolithic structure. Power output is +7 dBm typical from a 5V supply voltage. The voltage controlled oscillator is packaged in a low cost, surface mount 16 leaded QSOP package with an exposed base for improved RF and thermal performance. The HMC398QS16G & HMC398QS16GE require no external components

Electrical Specifications, $T_A = +25^\circ C$, $V_{cc1}, V_{cc2} = +5.0V$

Parameter	Min.	Typ.	Max.	Units
Frequency Range	14.0 - 15.0			GHz
Power Output	RF Output Divided Output	+3 -9	+7 -6	dBm dBm
SSB Phase Noise @ 100 kHz Offset, $V_{tune} = +5V$ @ RF Output		-105		dBc/Hz
Tune Voltage	V_{tune}	1.0	10.0	V
Supply Current	Icc 1 (Digital) Icc 2 (RF)		65 260	mA mA
Tune Port Leakage Current ($V_{tune} = 10V$)			10	μA
Output Return Loss		2		dB
Harmonics/Subharmonics	1/2 3/2 2nd 5/2		-20 -30 -12 -40	dBc dBc dBc dBc
Pulling (into a 2.0:1 VSWR)		4		MHz pp
Pushing @ $V_{tune} = 5V$		30		MHz/V
Frequency Drift Rate		1.5		MHz/ $^\circ C$

For price, delivery, and to place orders, please contact Hittite Microwave Corporation:
20 Alpha Road, Chelmsford, MA 01824 Phone: 978-250-3343 Fax: 978-250-3373
Order On-line at www.hittite.com

Ku-Band MMIC VCO with DIVIDE-BY-8, 14.0 - 15.0 GHz

Frequency vs. Tuning Voltage, $T = 25^\circ\text{C}$

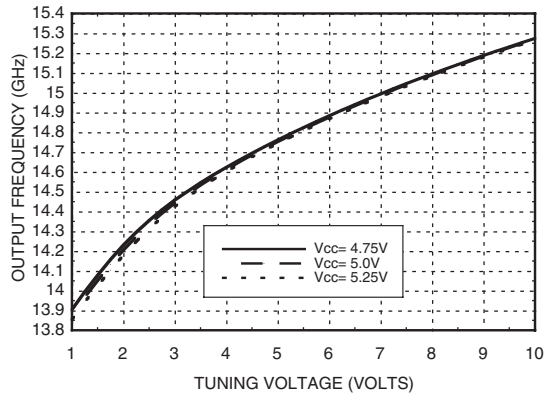

Frequency vs. Tuning Voltage, $V_{cc} = +5V$

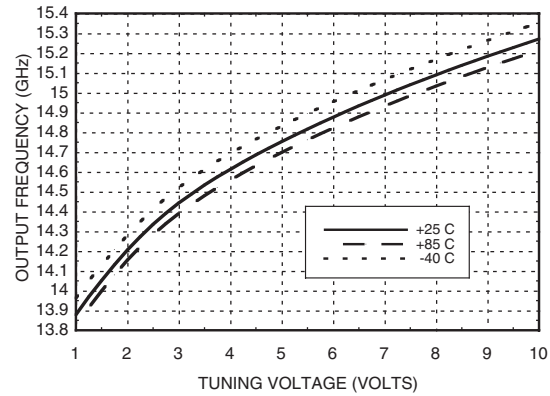

Sensitivity vs. Tuning Voltage, $V_{cc} = +5V$

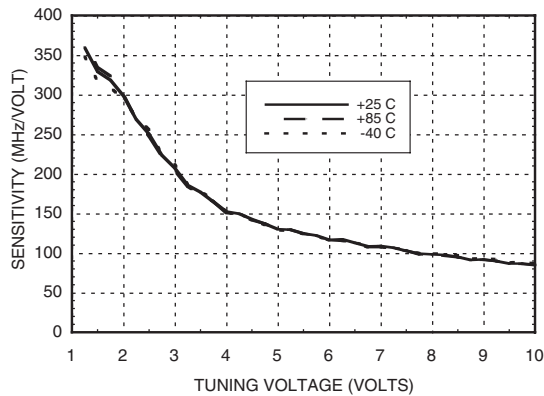

Output Power vs. Tuning Voltage, $V_{cc} = +5V$

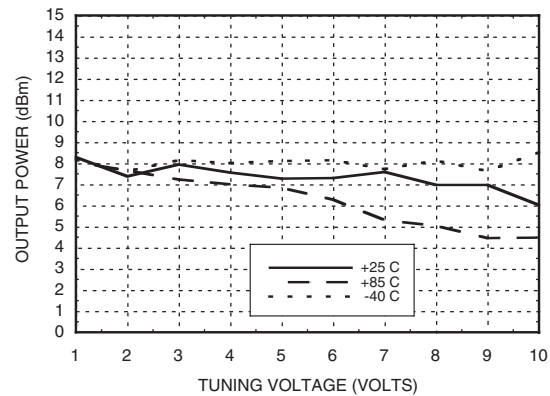

SSB Phase Noise vs. Tuning Voltage

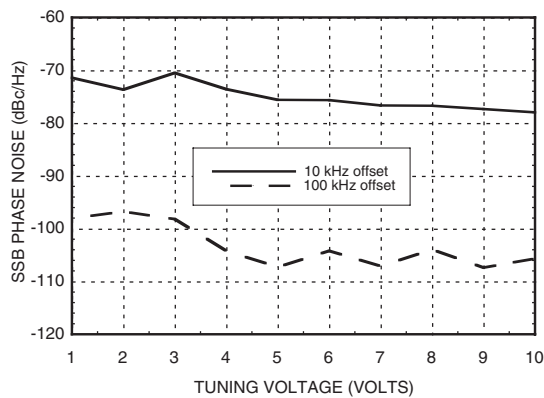

SSB Phase Noise @ $V_{tune} = 5V$

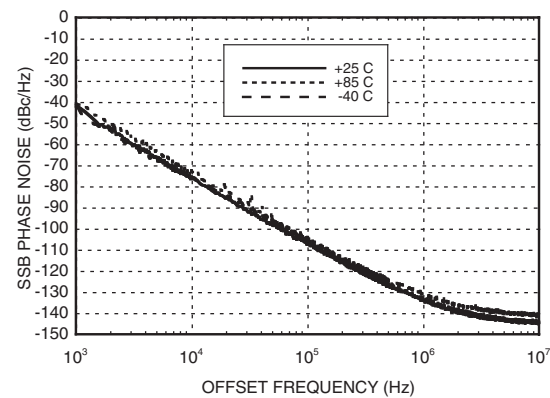



**Ku-Band MMIC VCO with
DIVIDE-BY-8, 14.0 - 15.0 GHz**

**Divided Output
Frequency vs. Tuning Voltage, Vcc= +5V**

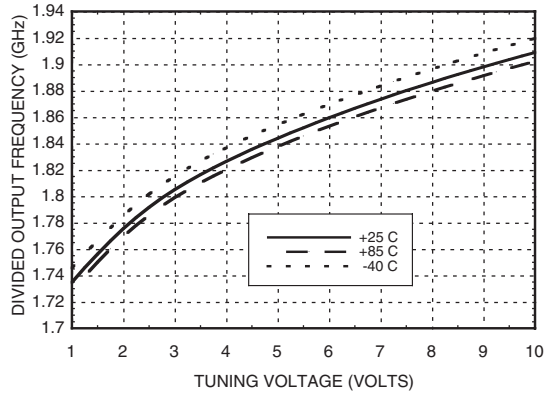

**Divided Output
Power vs. Tuning Voltage, Vcc= +5V***

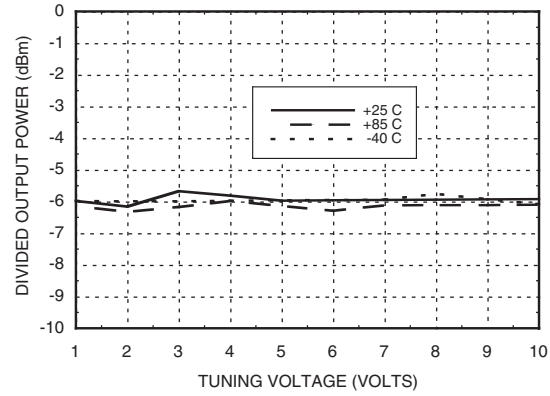

**Divided Output
SSB Phase Noise @ Vtune = 5V**

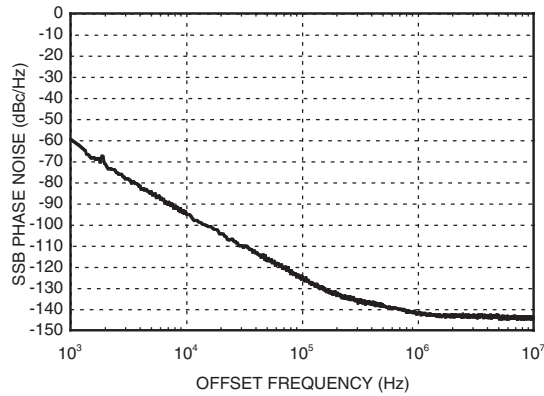

*Note: Tuning voltage must not drop below 1.0V for proper divider output.

Absolute Maximum Ratings

Vcc1, Vcc2	+5.5
Storage Temperature	-65 to +150 °C
Operating Temperature	-40 to +85 °C
Vtune	0 to 11V

Typical Supply Current vs. Vcc

Vcc (V)	Icc (mA)
4.75	300
5.0	325
5.25	350

Note: VCO will operate over full voltage range shown above.



**ELECTROSTATIC SENSITIVE DEVICE
OBSERVE HANDLING PRECAUTIONS**

Outline Drawing

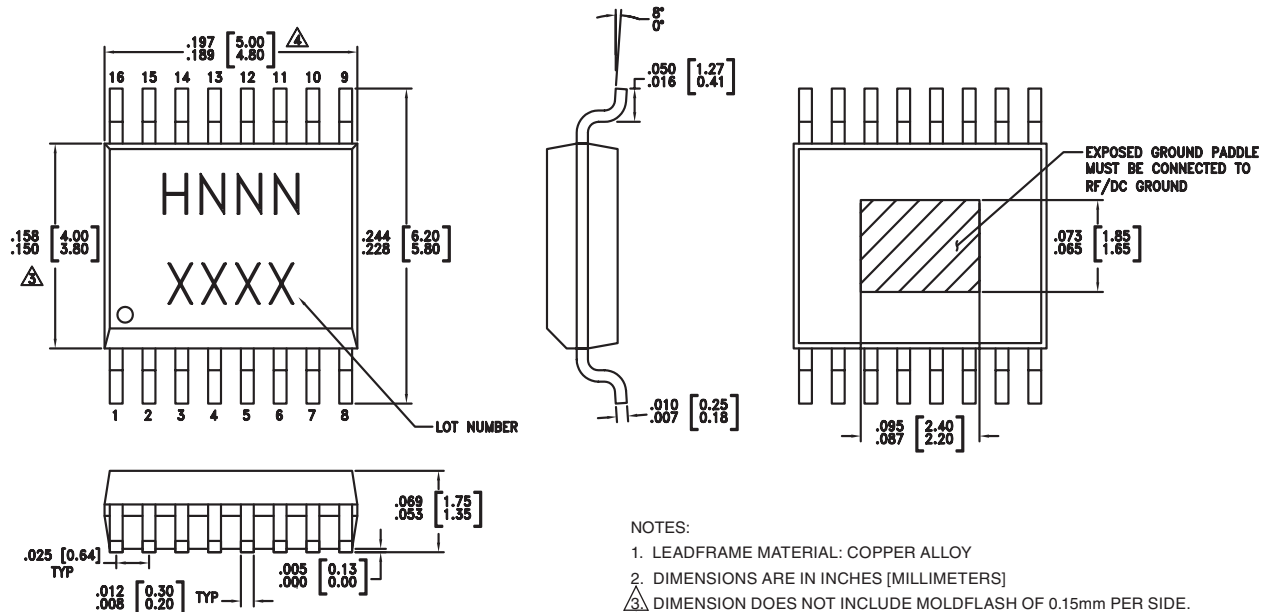



- NOTES:
- LEADFRAME MATERIAL: COPPER ALLOY
 - DIMENSIONS ARE IN INCHES [MILLIMETERS]
 - DIMENSION DOES NOT INCLUDE MOLDFLASH OF 0.15mm PER SIDE.
 - DIMENSION DOES NOT INCLUDE MOLDFLASH OF 0.25mm PER SIDE.
 - ALL GROUND LEADS AND GROUND PADDLE MUST BE SOLDERED TO PCB RF GROUND.

Package Information

Part Number	Package Body Material	Lead Finish	MSL Rating	Package Marking ^[3]
HMC398QS16G	Low Stress Injection Molded Plastic	Sn/Pb Solder	MSL1 ^[1]	H398 XXXX
HMC398QS16GE	RoHS-compliant Low Stress Injection Molded Plastic	100% matte Sn	MSL1 ^[2]	H398 XXXX

[1] Max peak reflow temperature of 235 °C
 [2] Max peak reflow temperature of 260 °C
 [3] 4-Digit lot number XXXX

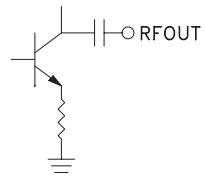
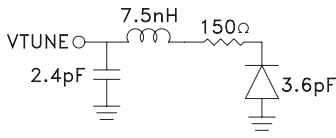
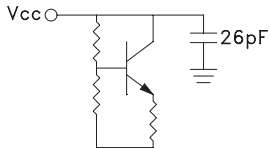
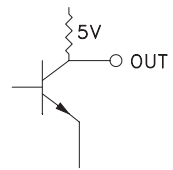
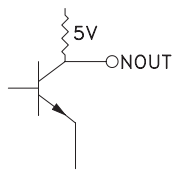
Pin Descriptions

Pin Number	Function	Description	Interface Schematic
1	RFOUT	RF output (AC coupled).	
2, 3, 4, 6, 8, 9, 10, 13, 14, 16	N/C	No Connection	
5	VTUNE	Control Voltage Input. Modulation port bandwidth dependent on drive source impedance.	
7, 15	VCC1, VCC2	Supply Voltage, 5V	
11	OUT	Divided Output	
12	NOUT	Divided Output 180° output phase with pin 11.	
	GND	Package bottom has an exposed metal paddle that must be RF & DC grounded.	

Evaluation PCB

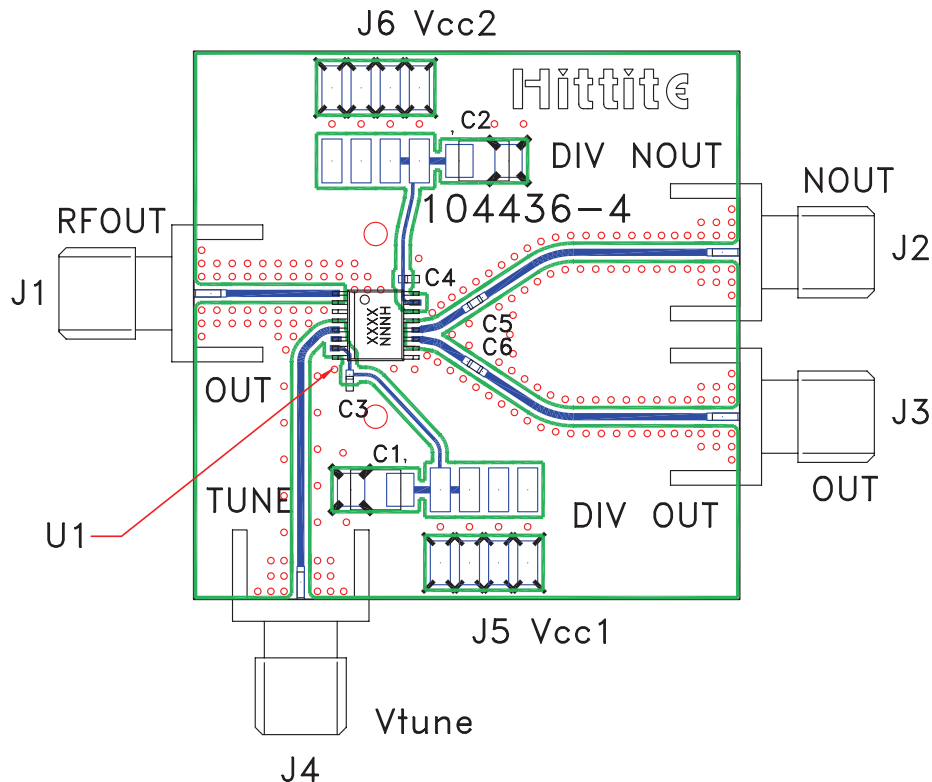

List of Materials for Evaluation PCB 104711 [1]

Item	Description
J1 - J4	PCB Mount SMA RF Connector
J5 - J6	2 mm DC Header
C1 - C2	10 μ F Tantalum Capacitor
C3 - C6	1,000 pF Capacitor 0402 Pkg.
U1	HMC398QS16G / HMC398QS16GE VCO
PCB [2]	104436 Eval Board

[1] Reference this number when ordering complete evaluation PCB

[2] Circuit Board Material: Rogers 4350

The circuit board used in the final application should use RF circuit design techniques. Signal lines should have 50 ohm impedance while the package ground leads and backside ground slug should be connected directly to the ground plane similar to that shown. A sufficient number of via holes should be used to connect the top and bottom ground planes. The evaluation circuit board shown is available from Hittite upon request.



Typical Application Circuit

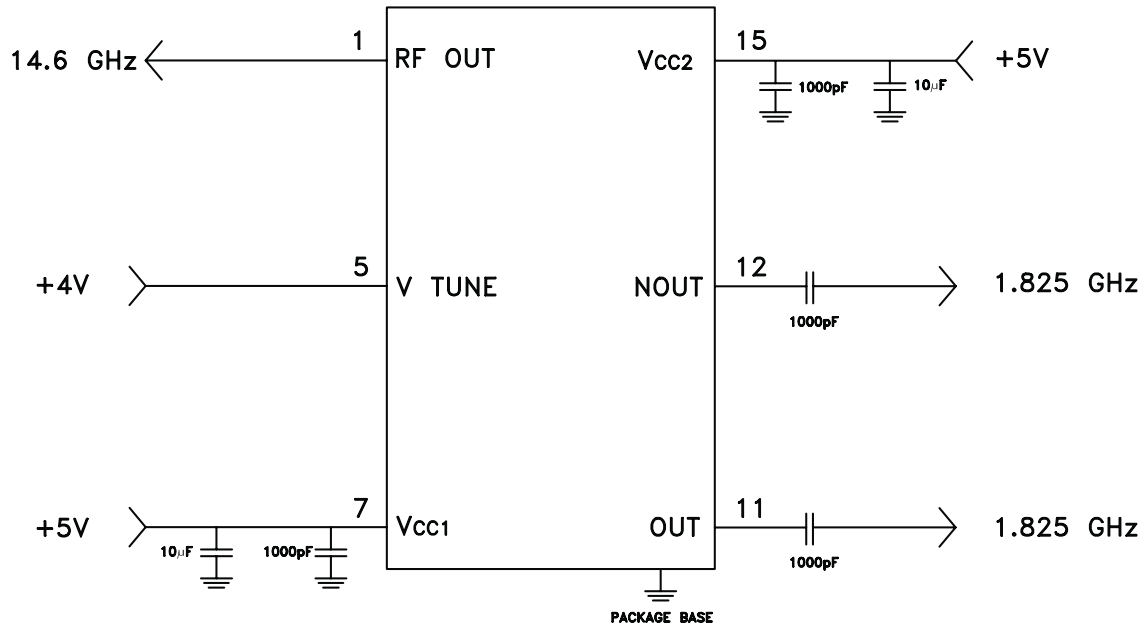



Notes: