

# 13.5-15.5 GHz 1.5W QFN Plastic Packaged Power Amplifier

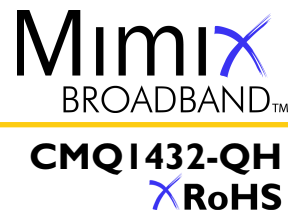

February 2008 - Rev 03-Feb-08

## Features

- ✕ 32 dBm (Typ) Saturated Output Power
- ✕ 33 dB (Typ) Linear Gain
- ✕ ESD Protection On Die
- ✕ Unconditionally Stable
- ✕ Low Cost, Surface Mount Package
- ✕ 4x4x1.4 mm
- ✕ RoHS Compliant
- ✕ 7V, 770mA

## Applications

- ✕ Ku-Band VSAT Transmit Subsystems

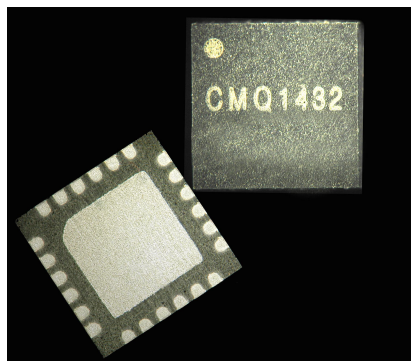

## General Description

The CMQ1432-QH is a pHEMT power amplifier packaged in a 4X4 QFN plastic package. The CMQ1432-QH is self contained with 50 ohm input and output terminals. The PAM is unconditionally stable and the internal matching allows for a reduction in external components making this product a simple and low cost solution. RoHS compliance and on-chip ESD protection make it an ideal solution in all manufacturing environments. The power amplifier is intended for use as the final RF amplifier in the extended Ku-Band satellite applications.

## Absolute Maximum Ratings

Drain Voltage (+Vdd)	+8 V
Gate Voltage (Vgg)	-3 V
Quiescent Current (Idq)	1000 mA
Gate Current (I <sub>g</sub> )	5 mA
RF Input Power (P <sub>in</sub> )	+11 dBm
Dissipated Power (P <sub>iss</sub> )	8 W
Storage Temperature	-50 °C to +150 °C
Operating Backside Temperature	-40 °C to +80 °C

## Electrical Characteristics (T = +25°C, V<sub>d</sub> = 7V, I<sub>d</sub> = 770mA)

Parameter	Units	Min.	Typ.	Max.
Operating Frequency (F)	GHz	13.5		15.5
Drain Current (At Saturation) (I <sub>d</sub> )	mA		770	
Drain Voltage (V <sub>d</sub> )	Volts	6	7	7.5
Gate Voltage (RF ON) (V <sub>g</sub> )	Volts	-2	-	-0.2
Linear Gain (S <sub>21</sub> )	dB		33	
Input Reflection Coefficient (S <sub>11</sub> )	dB		-11	
Output Reflection Coefficient (S <sub>22</sub> )	dB		-8	
Noise Figure (NF)	dB		9	
Saturated Output Power (P <sub>sat</sub> )	dBm	31.0	32	
Power @ 1dB Compression Gain (P <sub>1dB</sub> )	dBm		29	
Power Added Efficiency (At Saturation) (PAE)	%		27	
Gate Current (I <sub>gs</sub> )	mA	-	1.5	5

## Electrical Specifications (T<sub>A</sub> = -25C to 80C) Operation outside these limits can cause permanent damage.

Parameter	Condition	Units	Min	Typ	Max
Saturated Output Power	Variation from room temperature	dB	-0.7		
Linear Gain	Variation from room temperature	dB	-2.5		2.5
Stability			Unconditionally Stable		

Mimix Broadband, Inc., 10795 Rockley Rd., Houston, Texas 77099  
Tel: 281.988.4600 Fax: 281.988.4615 mimixbroadband.com

Page 1 of 7

Characteristic Data and Specifications are subject to change without notice. ©2008 Mimix Broadband, Inc.  
Export of this item may require appropriate export licensing from the U.S. Government. In purchasing these parts, U.S. Domestic customers accept their obligation to be compliant with U.S. Export Laws.

# 13.5-15.5 GHz 1.5W QFN Plastic Packaged Power Amplifier



February 2008 - Rev 03-Feb-08

CMQI432-QH  
RoHS

## Typical Performance

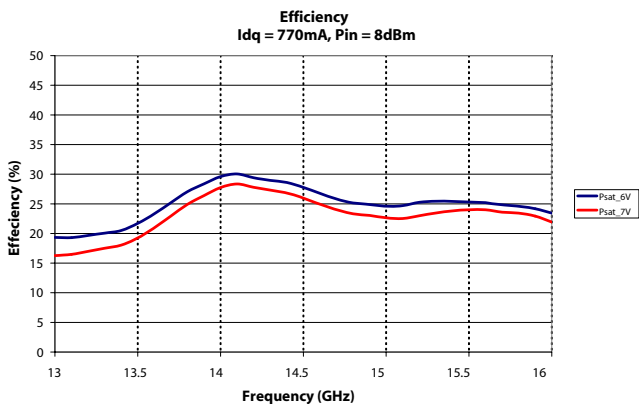
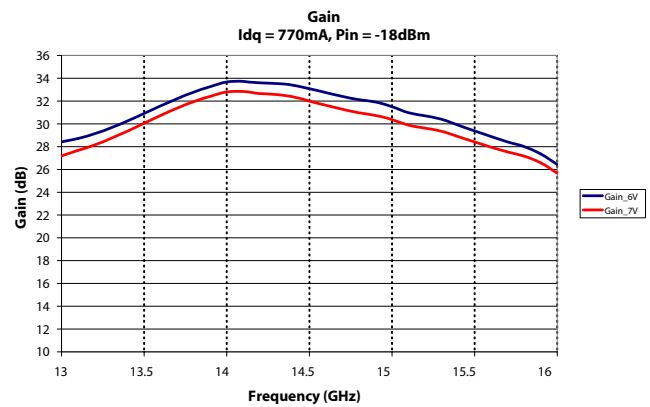
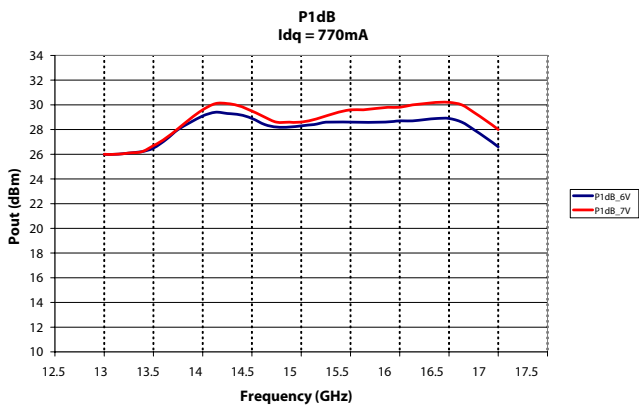
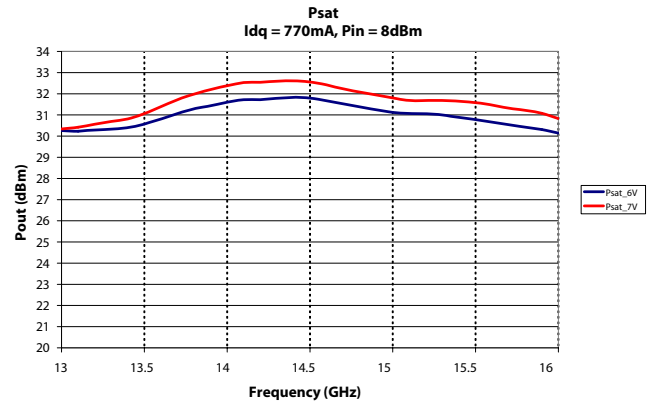
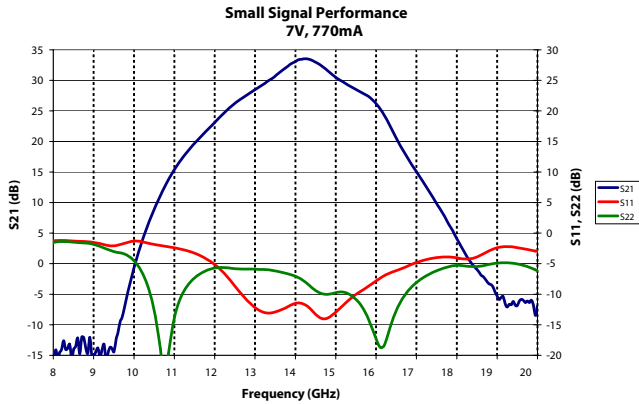

# 13.5-15.5 GHz 1.5W QFN Plastic Packaged Power Amplifier



February 2008 - Rev 03-Feb-08

CMQI432-QH  
RoHS

## Typical Performance

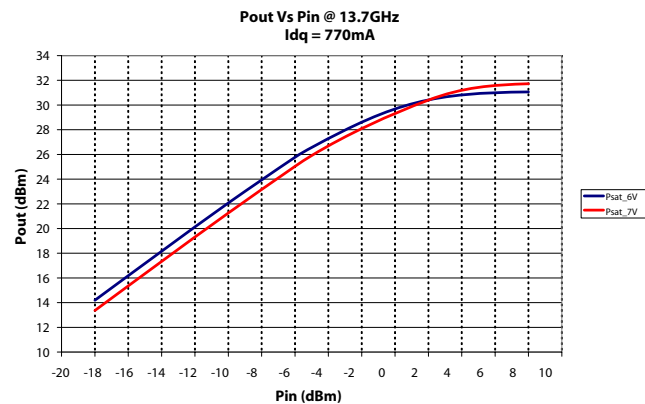
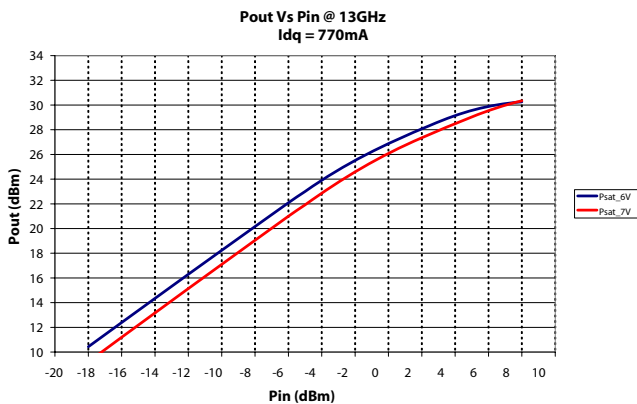
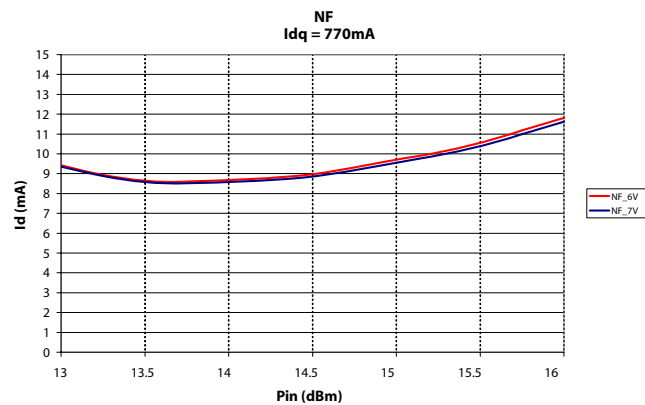
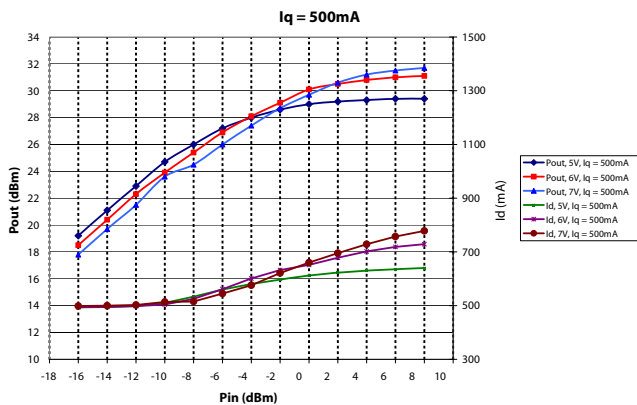
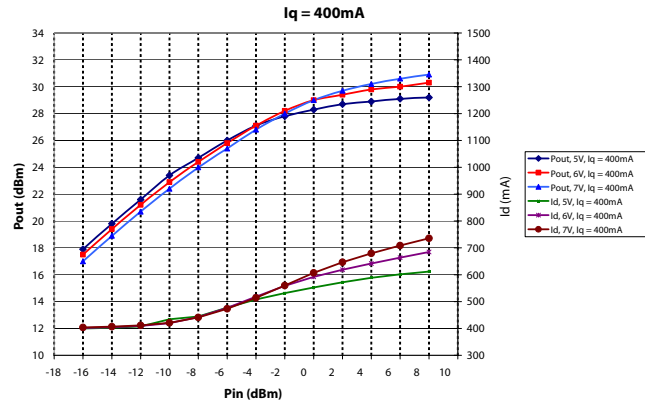
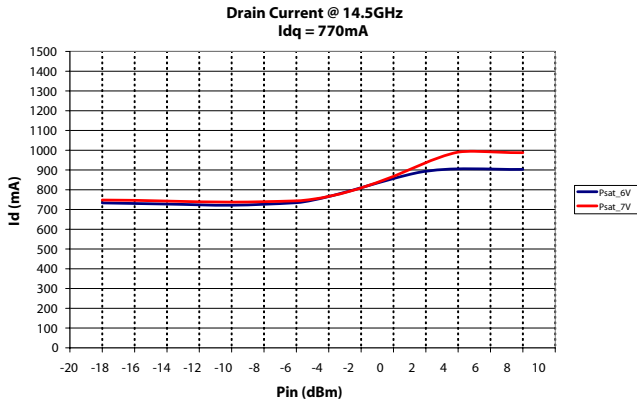

# 13.5-15.5 GHz 1.5W QFN Plastic Packaged Power Amplifier



February 2008 - Rev 03-Feb-08

CMQI432-QH  
RoHS

## Typical Performance

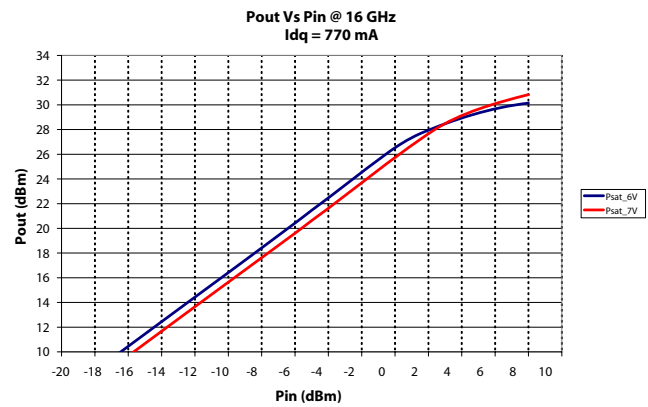
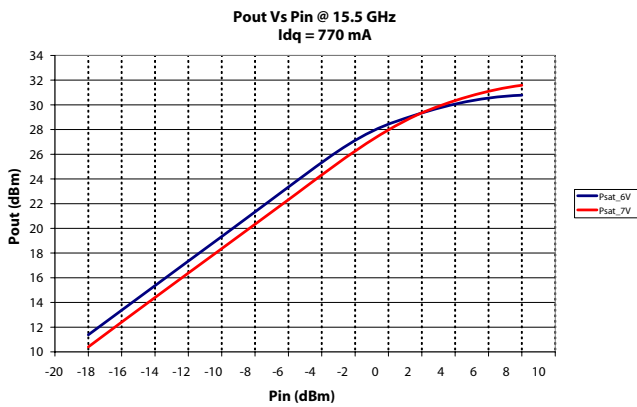
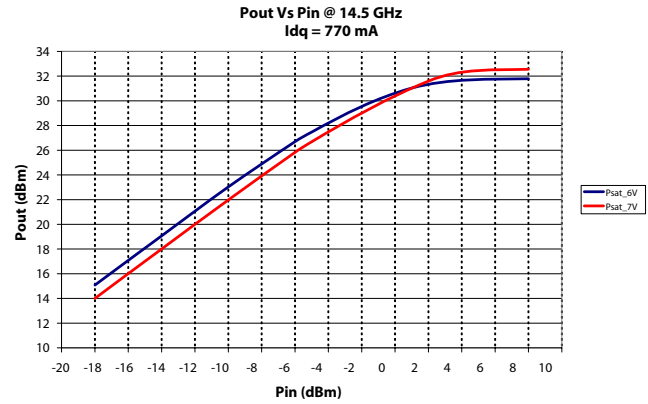
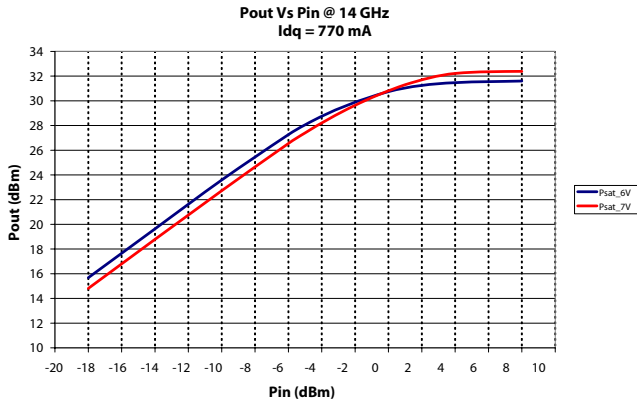

# 13.5-15.5 GHz 1.5W QFN Plastic Packaged Power Amplifier



February 2008 - Rev 03-Feb-08

**CMQI432-QH**  
RoHS

## Recommended Application Circuit

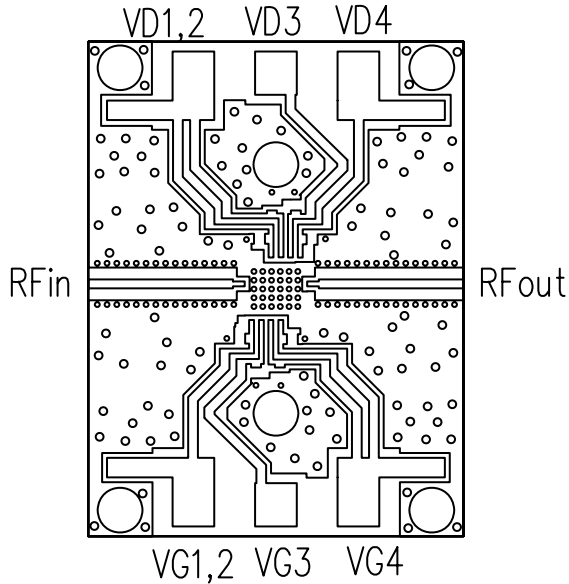

## Pin Designations

Pin Designator	Description
1,2,4,5,6,10,11,12,13,14,15,17,18,23,24	N/C
3	RF in
7,8,9	Vg
16	RF out
19	Vd4
20	Vd3
21	Vd2
22	Vd1

## Schematic

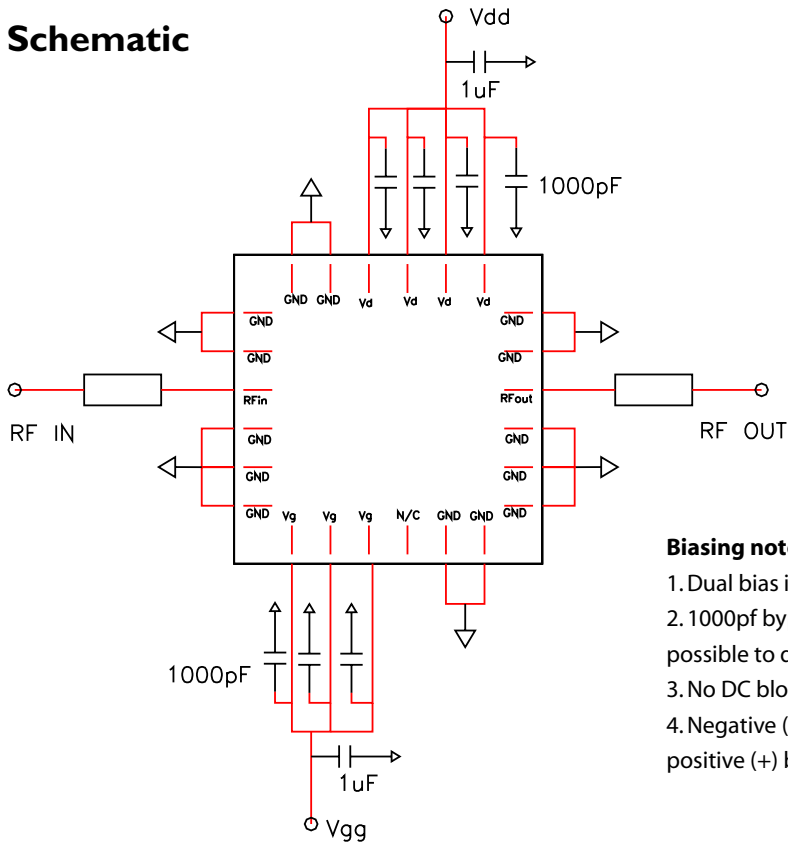

### Biasing notes:

1. Dual bias is required.
2. 1000pf bypass capacitors are needed on PC board as close as possible to device as shown in the schematic.
3. No DC block is required at RF IN/OUT
4. Negative (-) bias must be applied to Vgg before applying positive (+) bias to Vdd.

# 13.5-15.5 GHz 1.5W QFN Plastic Packaged Power Amplifier



February 2008 - Rev 03-Feb-08

**CMQ1432-QH**  
RoHS

## Physical Dimensions

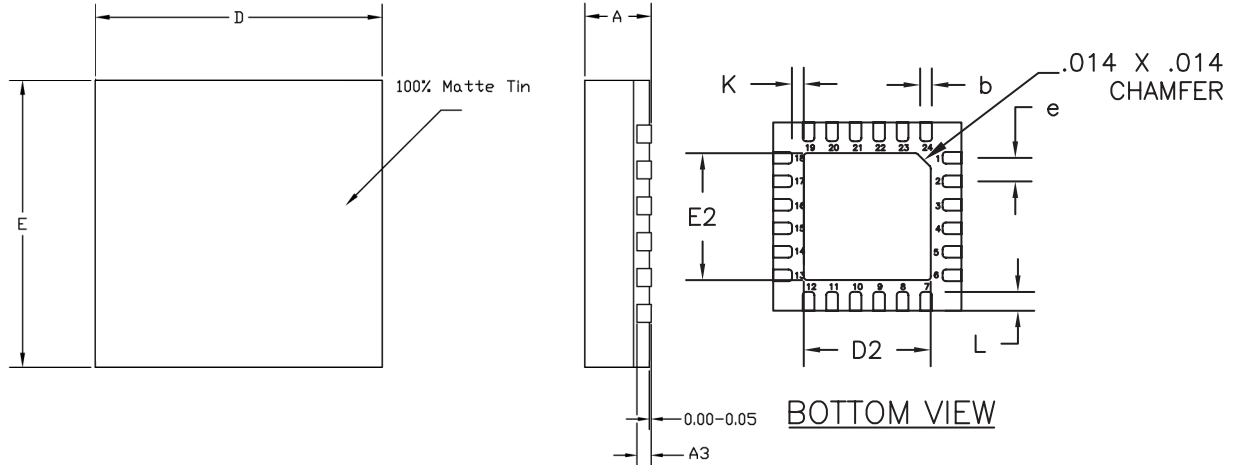

RECOMMENDED SOLDER PAD PITCH AND DIMENSIONS

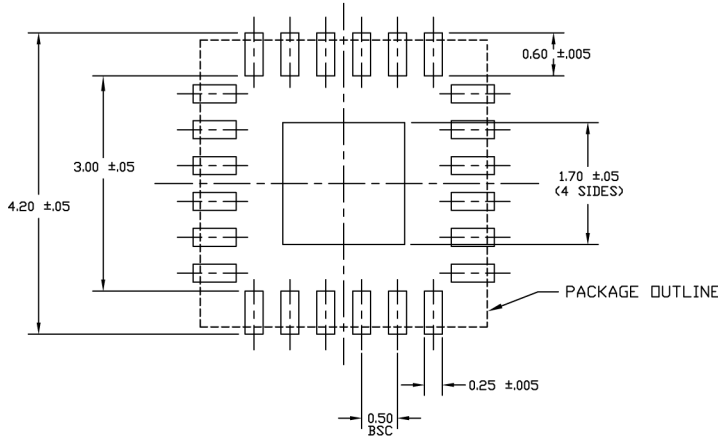

NOTE:  
1. ALL DIMENSIONS ARE IN mm

	MIN	NOM	MAX
A	0.80	0.90	1.00
A3	0.20 REF		
b	0.20	0.25	0.30
K	0.20	-	-
D	4.00 BSC		
E	4.00 BSC		
e	0.50		
D2	2.45	2.60	2.75
E2	2.45	2.60	2.75
L	0.20	0.30	0.40

## Marking

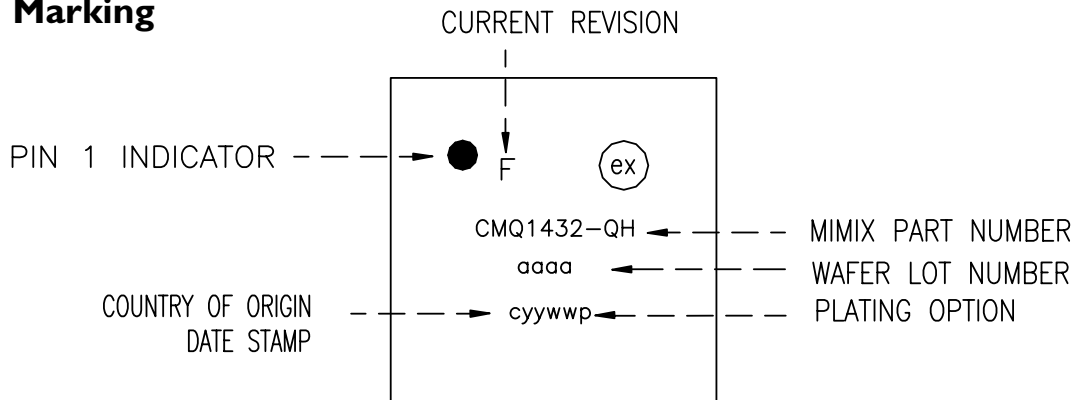

# 13.5-15.5 GHz 1.5W QFN Plastic Packaged Power Amplifier

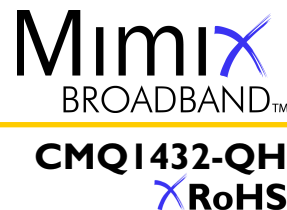

February 2008 - Rev 03-Feb-08

## Handling and Assembly Information

**CAUTION!** - Mimix Broadband MMIC Products contain gallium arsenide (GaAs) which can be hazardous to the human body and the environment. For safety, observe the following procedures:

- Do not ingest.
- Do not alter the form of this product into a gas, powder, or liquid through burning, crushing, or chemical processing as these by-products are dangerous to the human body if inhaled, ingested, or swallowed.
- Observe government laws and company regulations when discarding this product. This product must be discarded in accordance with methods specified by applicable hazardous waste procedures.

**Life Support Policy** - Mimix Broadband's products are not authorized for use as critical components in life support devices or systems without the express written approval of the President and General Counsel of Mimix Broadband. As used herein: (1) Life support devices or systems are devices or systems which, (a) are intended for surgical implant into the body, or (b) support or sustain life, and whose failure to perform when properly used in accordance with instructions for use provided in the labeling, can be reasonably expected to result in a significant injury to the user. (2) A critical component is any component of a life support device or system whose failure to perform can be reasonably expected to cause the failure of the life support device or system, or to affect its safety or effectiveness.

**Package Attachment** - This packaged product from Mimix Broadband is provided as a rugged surface mount package compatible with high volume solder installation. Care should be taken not to apply heavy pressure to the top or base material to avoid package damage. Vacuum tools or other suitable pick and place equipment may be used to pick and place this part. Care should be taken to ensure that there are no voids or gaps in the solder connection so that good RF, DC and ground connections are maintained. Voids or gaps can eventually lead not only to RF performance degradation, but reduced reliability and life of the product due to thermal stress.

### Typical Reflow Profiles

Reflow Profile	SnPb	Pb Free
Ramp Up Rate	3-4 °C/sec	3-4 °C/sec
Activation Time and Temperature	60-120 sec @ 140-160 °C	60-180 sec @ 170-200 °C
Time Above Melting Point	60-150 sec	60-150 sec
Max Peak Temperature	240 °C	265 °C
Time Within 5 °C of Peak	10-20 sec	10-20 sec
Ramp Down Rate	4-6 °C/sec	4-6 °C/sec

**Mimix Lead-Free RoHS Compliant Program** - Mimix has an active program in place to meet customer and governmental requirements for eliminating lead (Pb) and other environmentally hazardous materials from our products. All Mimix RoHS compliant components are form, fit and functional replacements for their non-RoHS equivalents. Lead plating of our RoHS compliant parts is 100% matte tin (Sn) over copper alloy and is backwards compatible with current standard SnPb low-temperature reflow processes as well as higher temperature (260°C reflow) "Pb Free" processes.

## Ordering Information

### Part Number for Ordering

CMQ1432-QH-0G00  
CMQ1432-QH-0G0T  
PB-CMQ1432-QH-0000

### Description

Matte Tin plated RoHS compliant QFN4X4 24L surface mount package in bulk quantity  
Matte Tin plated RoHS compliant QFN4X4 24L Surface mount package in tape and reel  
CMQ1432-QH Evaluation Board

We also offer this part with SnPb (Tin-Lead) or NiPdAu plating. Please contact your regional sales manager for more information regarding different plating types.