

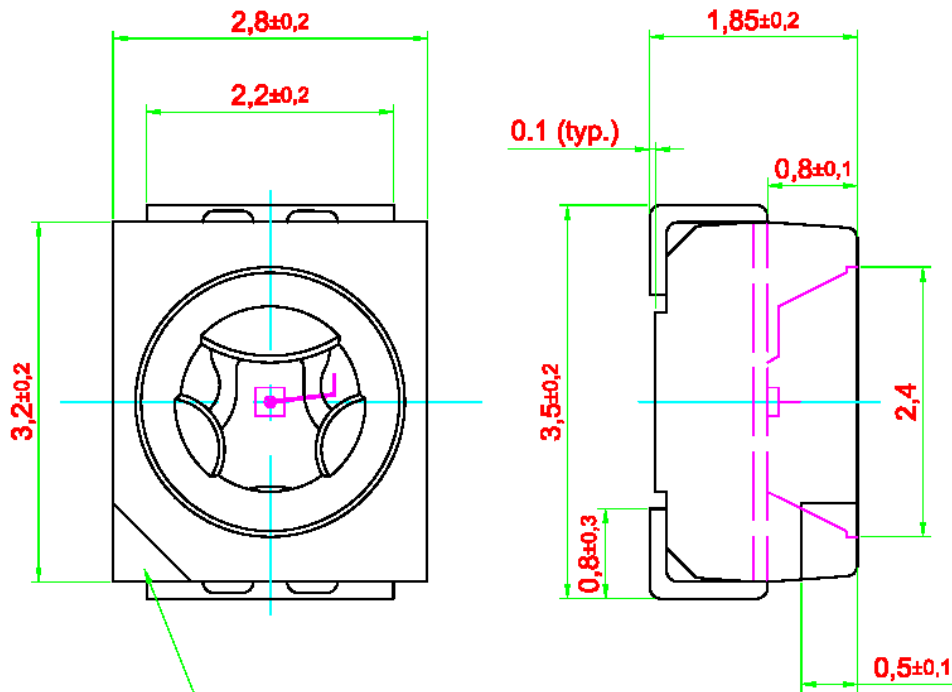

● Feature:

1. Surface mount LED.
2. 120° viewing angle.
3. Small package outline (LxWxH) of 3.2 x 2.8 x 1.8 mm.
4. Qualified according to JEDEC moisture sensitivity Level 2.
5. Compatible to both IR reflow soldering and TTW soldering.

● Package Dimension:



Cathode marking.

Recommended Solder Pad

Additional Cu area for improved heat dissipation.

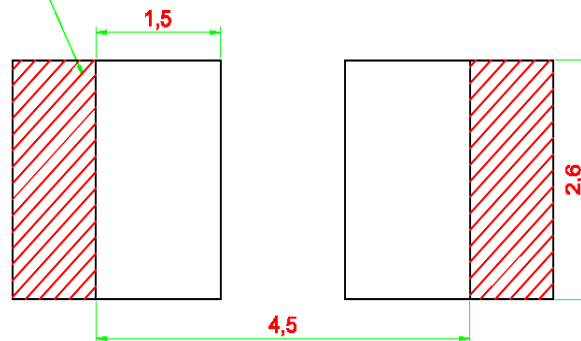

 Solder resist.



● **Optical Characteristics:**

Part Number	Chip Technology / Color	Luminous Intensity @ If = 10mA Iv (mcd)
BL-PDP-GJS-C10 <ul style="list-style-type: none"> • BIN G1 • BIN G2 • BIN H1 • BIN H2 	GaP / Green, 560 nm	1.80 ... 4.50
		1.80 ... 2.24
		2.24 ... 2.80
		2.80 ... 3.55
		3.55 ... 4.50

Forward voltage @ If=10 mA.	Chip Type	Viewing angle at 50% Iv	Reverse current, I _R @ V _R = 5V, (max)
2.05 V (typ.); 2.45 V (max)	GaP	120°	100 μA

NOTE:

1. Other luminous intensity groups are also available upon request.
2. Luminous intensity is measured with an accuracy of ±11%.
3. Wavelength binning is carried for all units as per the wavelength-binning table. Only one wavelength group is allowed for each reel.
4. An optional Vf binning is also available upon request. Binning scheme is as per following table.

● **Absolute Maximum Ratings:**

	Maximum Value	Unit
DC forward current.	30	mA
Peak pulse current; (tp ≤ 10 μs, Duty cycle = 0.005)	500	mA
Reverse voltage.	5	V
LED junction temperature.	100	°C
Operating temperature.	-40 ... +100	°C
Storage temperature.	-40 ... +100	°C
Power dissipation (at room temperature)	75	mW

● **Vf Binning:**

Vf Bin @ 10mA	Forward voltage (V)
01	1.25 ... 1.55
02	1.55 ... 1.85
03	1.85 ... 2.15
04	2.15 ... 2.45



● **Wavelength Grouping:**

Color	Group	Wavelength distribution (nm)
BL-PDP; Pure Green	Full	552.5 – 564.5
	W	552.5 – 555.5
	X	555.5 – 558.5
	Y	558.5 – 561.5
	Z	561.5 – 564.5

Wavelength is measured with an accuracy of ± 1 nm.

● **Typical electro-optical characteristics curves:**

Fig. 1 Relative luminous intensity vs. forward current.

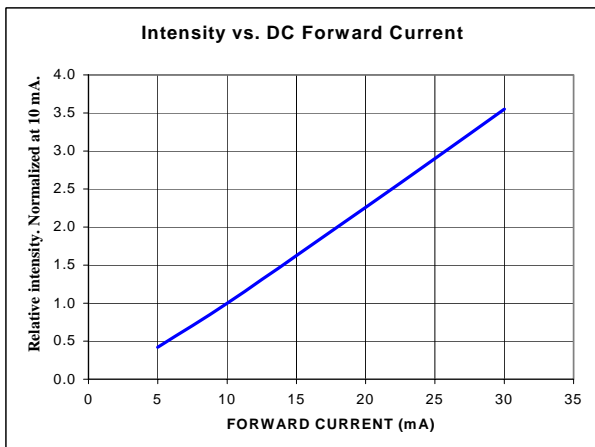

Fig. 2 Forward current vs. forward voltage.

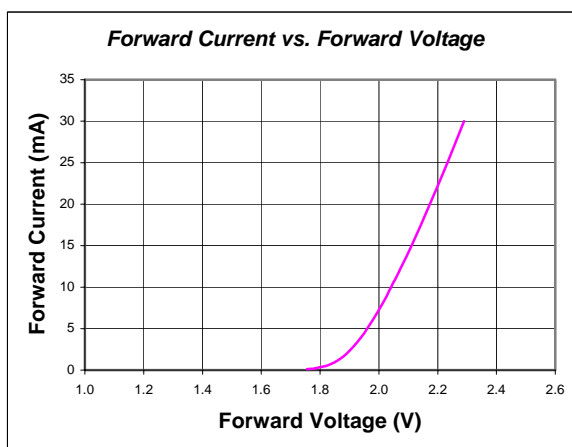

Fig. 3 Radiation pattern

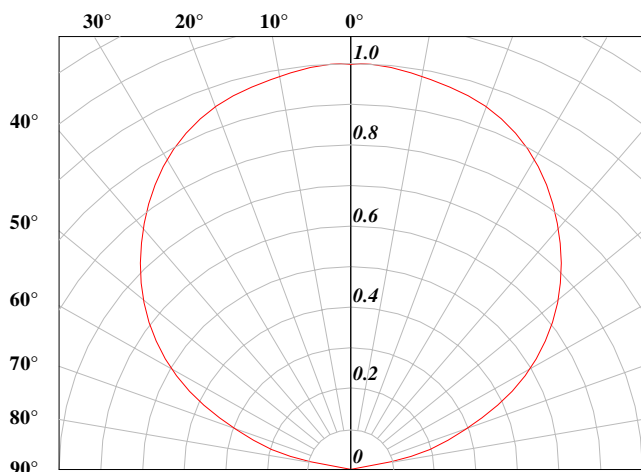

Fig. 4 Maximum forward current vs. temperature

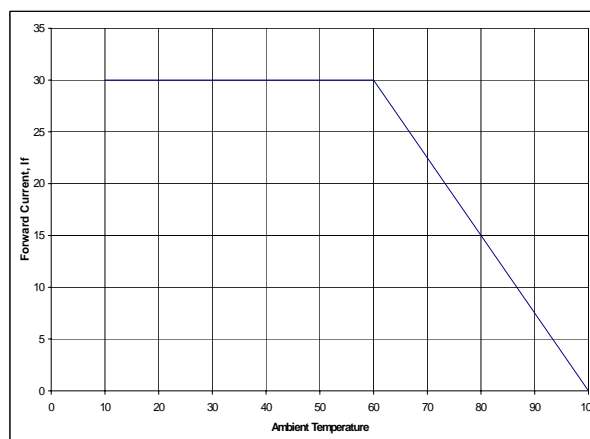



Fig. 5 Recommended IR-reflow Soldering Profile (acc. to IPC 9501)

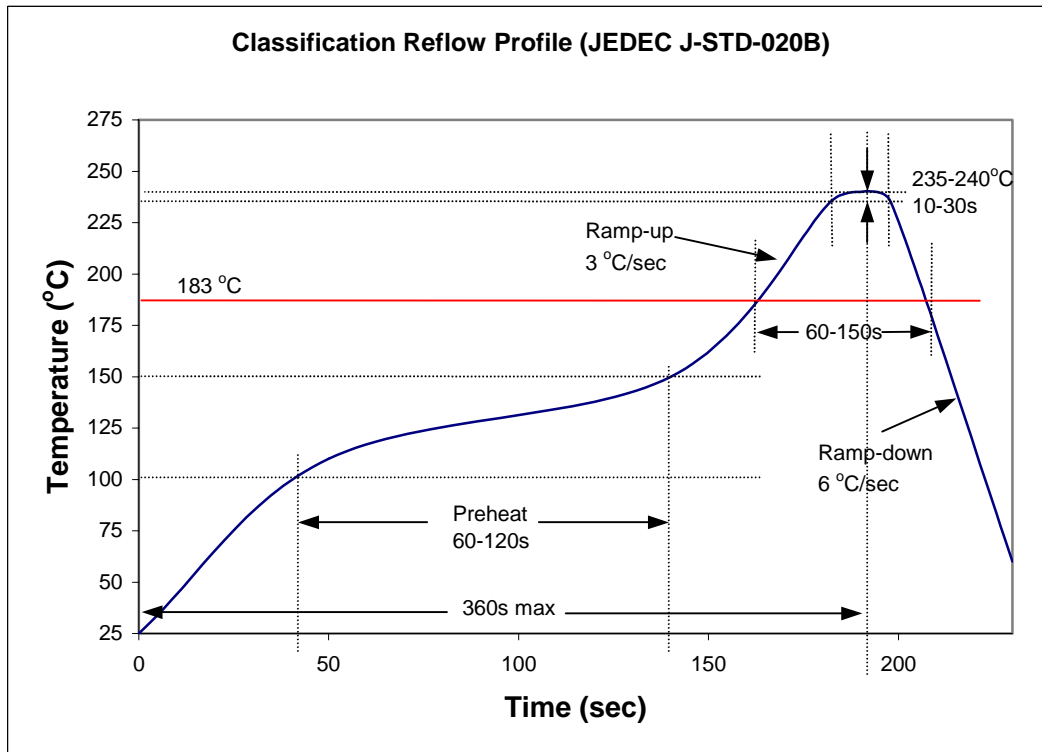
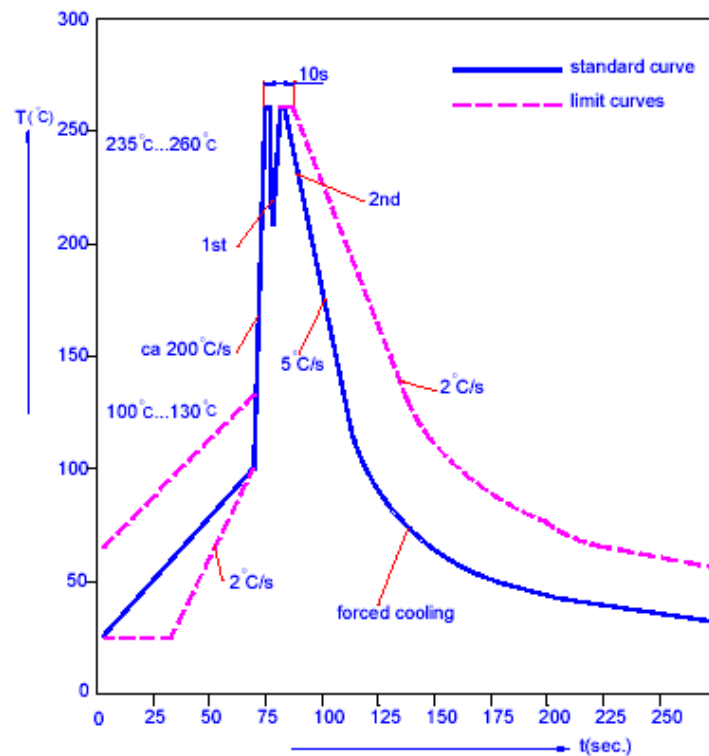

Fig. 6 Recommended TTW Soldering Profile (acc. to CECC 00802).





● Taping And Orientation.

Reels come in quantity of 2000 units. Reel diameters is 180 mm .

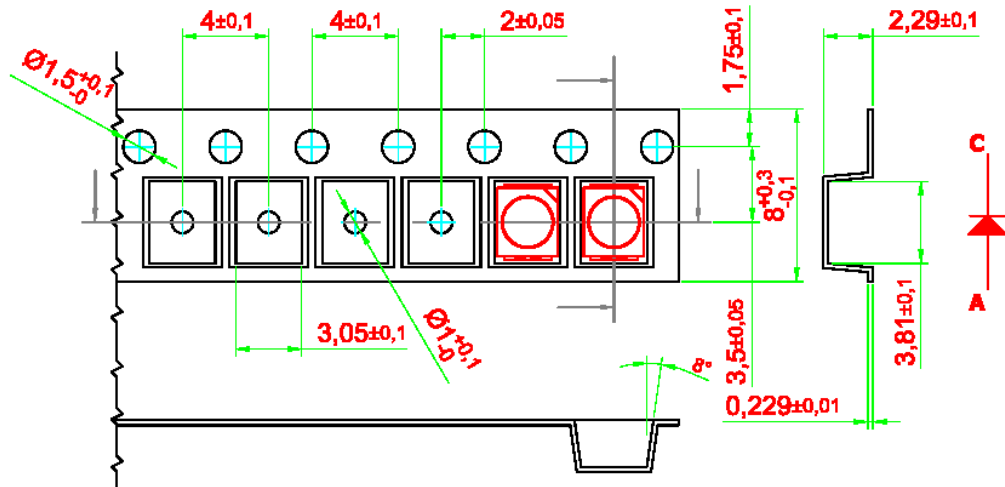

200 mm min. for $\phi 180$ reel.
200 mm min. for $\phi 330$ reel.

480 mm min. for $\phi 180$ reel.
960 mm min. for $\phi 330$ reel.

