

# International IR Rectifier

## 42CTQ030SPbF 42CTQ030-1PbF

SCHOTTKY RECTIFIER

40 Amp

$I_{F(AV)} = 40\text{Amp}$   
 $V_R = 30\text{V}$

### Major Ratings and Characteristics

Characteristics	Values	Units
$I_{F(AV)}$ Rectangular waveform	40	A
$V_{RRM}$	30	V
$I_{FSM}$ @ tp = 5 $\mu\text{s}$ sine	1100	A
$V_F$ @ 20 Apk, $T_J = 125^\circ\text{C}$ (per leg)	0.38	V
$T_J$ range	-55 to 150	$^\circ\text{C}$

### Description/ Features

This center tap Schottky rectifier has been optimized for very low forward voltage drop, with moderate leakage. The proprietary barrier technology allows for reliable operation up to 150° C junction temperature. Typical applications are in switching power supplies, converters, free-wheeling diodes, and reverse battery protection.

- 150° C  $T_J$  operation
- Center tap configuration
- Very low forward voltage drop
- High purity, high temperature epoxy encapsulation for enhanced mechanical strength and moisture resistance
- High frequency operation
- Guard ring for enhanced ruggedness and long term reliability
- Lead- Free ("PbF" suffix)

### Case Styles

42CTQ030SPbF

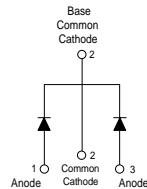

**D<sup>2</sup>PAK**

42CTQ030-1PbF

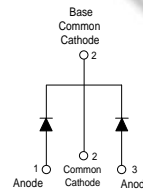

**TO-262**

## Voltage Ratings

Parameters	42CTQ030SPbF, 42CTQ030-1PbF
$V_R$ Max. DC Reverse Voltage (V)	30
$V_{RWM}$ Max. Working Peak Reverse Voltage (V)	

## Absolute Maximum Ratings

Parameters	Values	Units	Conditions
$I_{F(AV)}$ Max. Average Forward (Per Leg) Current * See Fig. 5 (Per Device)	20	A	50% duty cycle @ $T_C = 121^\circ\text{C}$ , rectangular wave form
	40		
$I_{FSM}$ Max. Peak One Cycle Non-Repetitive Surge Current (Per Leg) * See Fig. 7	1100	A	5 $\mu\text{s}$ Sine or 3 $\mu\text{s}$ Rect. pulse 10ms Sine or 6ms Rect. pulse Following any rated load condition and with rated $V_{RRM}$ applied
	360		
$E_{AS}$ Non-Repetitive Avalanche Energy (Per Leg)	13	mJ	$T_J = 25^\circ\text{C}$ , $I_{AS} = 3$ Amps, $L = 2.90$ mH
$I_{AR}$ Repetitive Avalanche Current (Per Leg)	3	A	Current decaying linearly to zero in 1 $\mu\text{sec}$ Frequency limited by $T_J$ max. $V_A = 1.5 \times V_R$ typical

## Electrical Specifications

Parameters	Values	Units	Conditions
$V_{FM}$ Max. Forward Voltage Drop (Per Leg) * See Fig. 1 (1)	0.48	V	@ 20A $T_J = 25^\circ\text{C}$
	0.57	V	@ 40A
	0.38	V	@ 20A $T_J = 125^\circ\text{C}$
	0.51	V	@ 40A
$I_{RM}$ Max. Reverse Leakage Current (Per Leg) * See Fig. 2 (1)	3	mA	$T_J = 25^\circ\text{C}$
	183	mA	$T_J = 125^\circ\text{C}$ $V_R = \text{rated } V_R$
$V_{F(TO)}$ Threshold Voltage	0.22	V	$T_J = T_J \text{ max.}$
$r_t$ Forward Slope Resistance	6.76	m $\Omega$	
$C_T$ Max. Junction Capacitance (Per Leg)	2840	pF	$V_R = 5V_{DC}$ (test signal range 100Khz to 1Mhz) $25^\circ\text{C}$
$L_S$ Typical Series Inductance (Per Leg)	8.0	nH	Measured lead to lead 5mm from package body
dv/dt Max. Voltage Rate of Change	10000	V/ $\mu\text{s}$	(Rated $V_R$ )

(1) Pulse Width < 300 $\mu\text{s}$ , Duty Cycle < 2%

## Thermal-Mechanical Specifications

Parameters	Values	Units	Conditions
$T_J$ Max. Junction Temperature Range	-55 to 150	$^\circ\text{C}$	
$T_{stg}$ Max. Storage Temperature Range	-55 to 150	$^\circ\text{C}$	
$R_{thJC}$ Max. Thermal Resistance Junction to Case (Per Leg)	2.0	$^\circ\text{C}/\text{W}$	DC operation
$R_{thJC}$ Max. Thermal Resistance Junction to Case (Per Package)	1.0	$^\circ\text{C}/\text{W}$	DC operation
$R_{thCS}$ Typical Thermal Resistance, Case to Heatsink	0.50	$^\circ\text{C}/\text{W}$	Mounting surface, smooth and greased
wt Approximate Weight	2 (0.07)	g (oz.)	
T Mounting Torque	Min.	6 (5)	Kg-cm (lbf-in)
	Max.	12 (10)	
Marking Device	42CTQ030S	Case style D <sup>2</sup> Pak	
	42CTQ030-1	Case style TO-262	

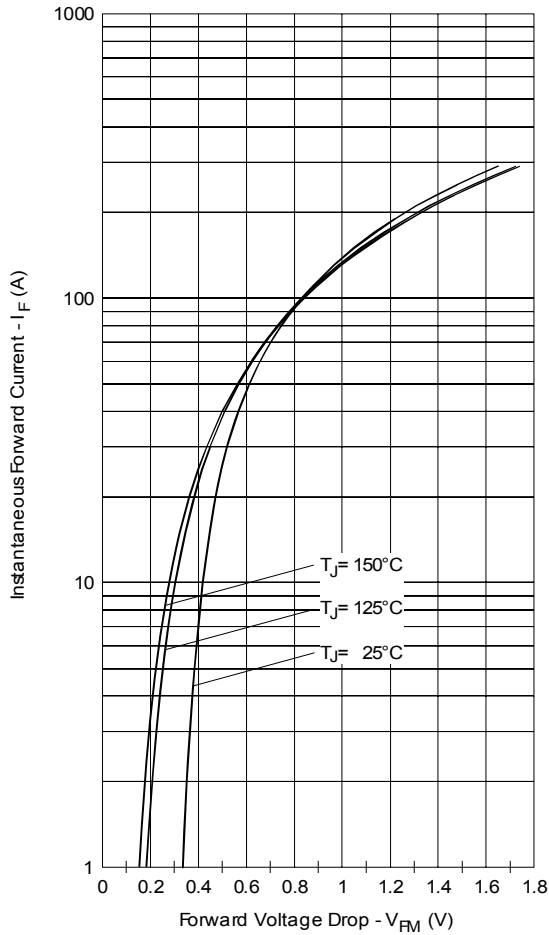

Fig. 1 - Max. Forward Voltage Drop Characteristics (Per Leg)

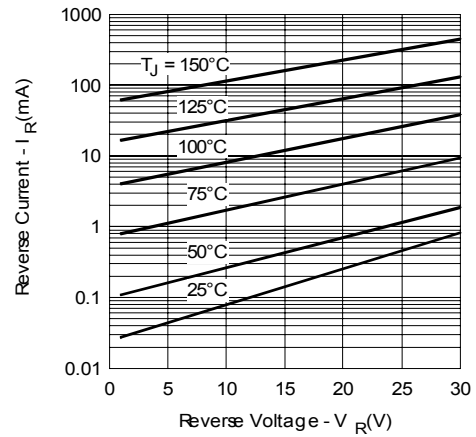

Fig. 2 - Typical Values Of Reverse Current Vs. Reverse Voltage (Per Leg)

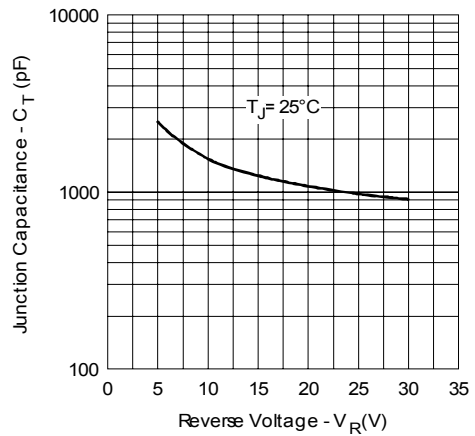

Fig. 3 - Typical Junction Capacitance Vs. Reverse Voltage (Per Leg)

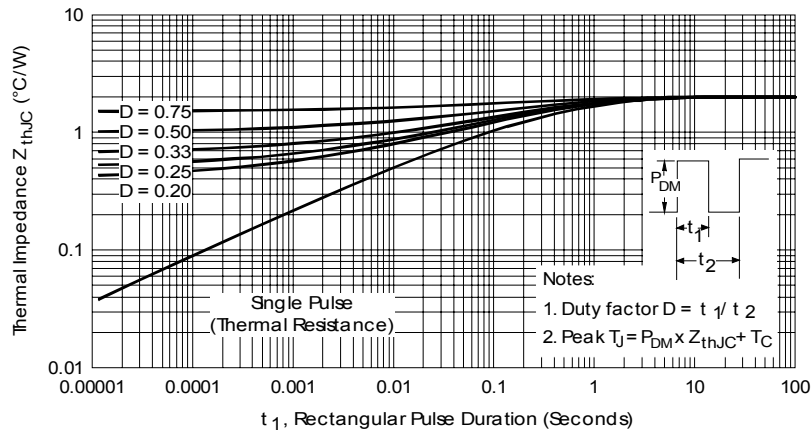

Fig. 4 - Max. Thermal Impedance  $Z_{thJC}$  Characteristics (Per Leg)

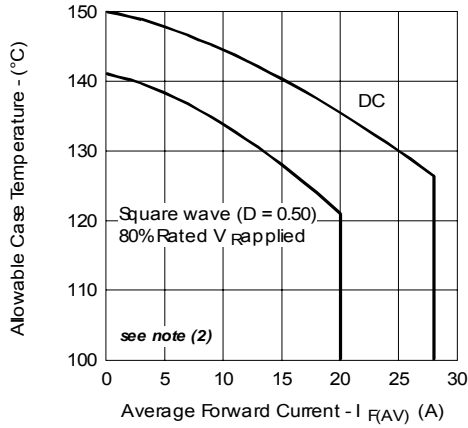

Fig. 5 - Max. Allowable Case Temperature Vs. Average Forward Current (Per Leg)

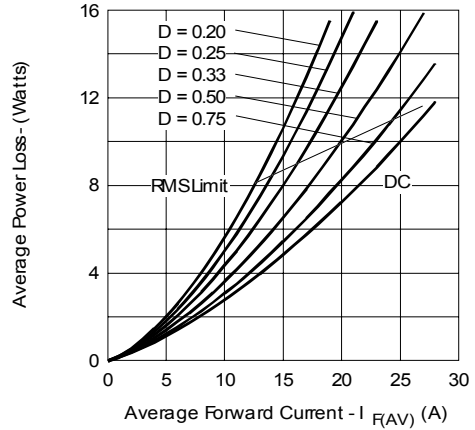

Fig. 6 - Forward Power Loss Characteristics (Per Leg)

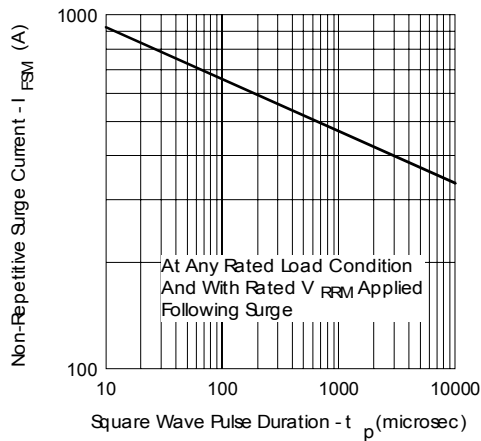

Fig. 7 - Max. Non-Repetitive Surge Current (Per Leg)

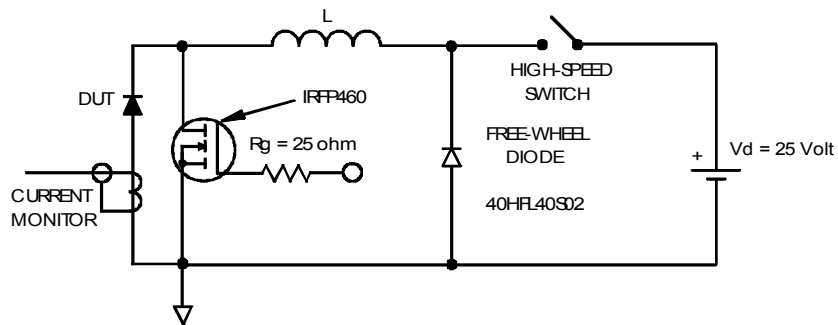

Fig. 8 - Unclamped Inductive Test Circuit

(2) Formula used:  $T_c = T_j - (P_d + P_{d_{REV}}) \times R_{thJC}$ ;

$P_d = \text{Forward Power Loss} = I_{F(AV)} \times V_{FM} @ (I_{F(AV)} / D)$  (see Fig. 6);

$P_{d_{REV}} = \text{Inverse Power Loss} = V_{R1} \times I_R (1 - D); I_R @ V_{R1} = 10V$

Outlines Table

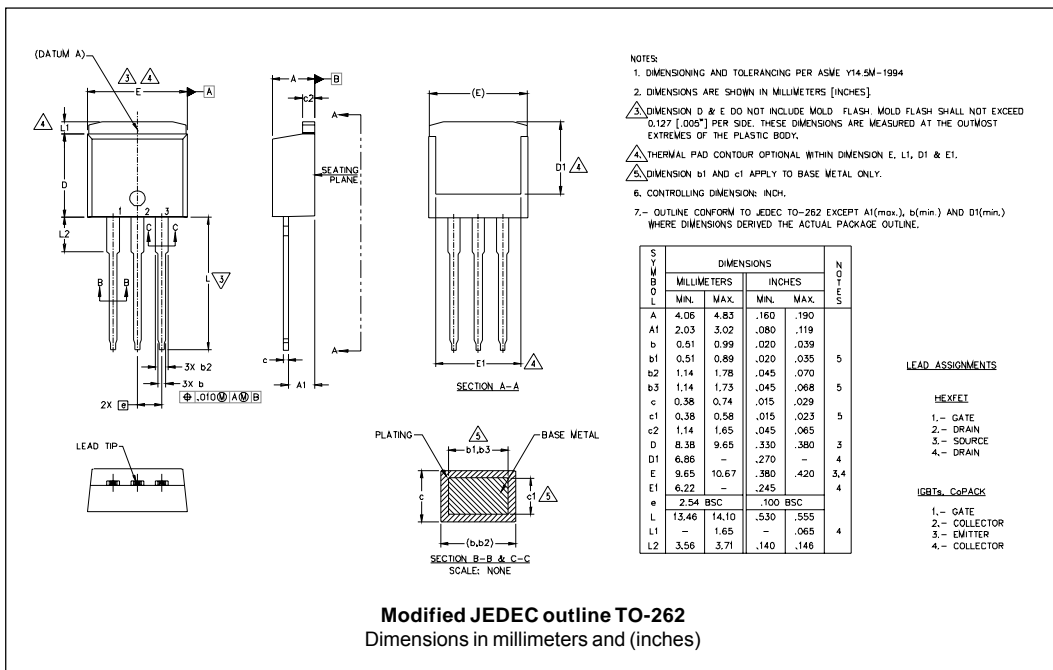
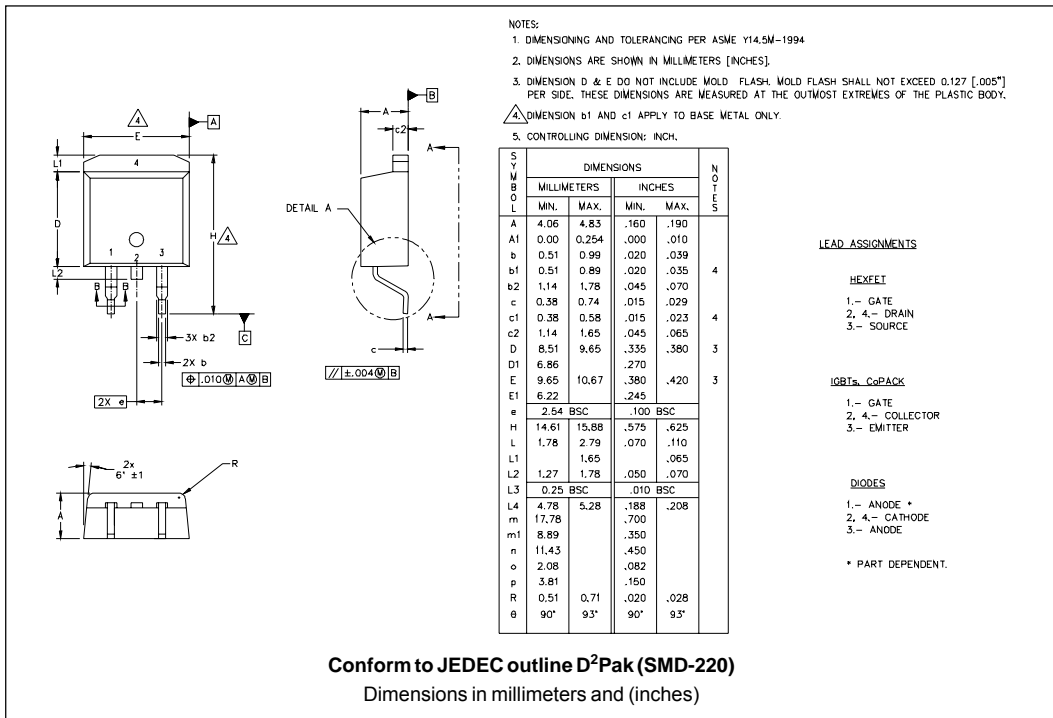

Part Marking Information

**D<sup>2</sup>PAK**

EXAMPLE: THIS IS A 42CTQ030S  
LOT CODE 8024  
ASSEMBLED ON WW 02, 2000

Note: "P" in assembly line position indicates "Lead-Free"

INTERNATIONAL RECTIFIER LOGO  
ASSEMBLY LOT CODE  
PART NUMBER  
DATE CODE  
YEAR 0 = 2000  
WEEK 02  
P = LEAD-FREE

**TO-262**

EXAMPLE: THIS IS A 42CTQ030-1  
LOT CODE 1789  
ASSEMBLED ON WW 19, 1999

Note: "P" in assembly line position indicates "Lead-Free"

INTERNATIONAL RECTIFIER LOGO  
ASSEMBLY LOT CODE  
PART NUMBER  
DATE CODE  
YEAR 9 = 1999  
WEEK 19  
P = LEAD-FREE

Tape & Reel Information

SECTION Y-Y

Ao	10.50	+/- 0.1
Bo	15.80	+/- 0.1
B2	10.25	+/- 0.1
Ko	4.90	+/- 0.1
F	11.50	+/- 0.1
P1	16.00	+/- 0.1
W	24.00	+/- 0.3

NOTES:

- 1.0 SPROCKET HOLE PITH CUMULATIVE TOLERANCE ±.02
- 2.0 CAMBER NOT TO EXCEED 1mm in 100mm
- 3.0 MATERIAL: CONDUCTIVE BLACK STYRENIC ALLOY
- 4.0 K<sub>0</sub> MEASURED FROM A PLANE ON THE INSIDE BOTTOM OF THE POCKET TO THE TOP SURFACE OF THE CARRIER
- 5.0 MEASURED FROM CENTRELINE OF SPROCKET HOLE TO CENTRELINE OF POCKET
- 6.0 VENDOR: (OPTIONAL)
- 7.0 MUST ALSO MEET REQUIREMENTS OF EIA STANDAR #EIA-481A TAPING OF SURFACE MOUNT COMPONENTS FOR AUTOMATIC PLACEMENT
- 8.0 SURFACE RESISTIVITY OF MOLDED MATL. MUST MEASURE LESS OR EQUAL TO 10<sup>6</sup> OHMS PER SQUARE. MEASURED IN ACCORDANCE TO PROCEDURE GIVEN IN ASTM D-257 & ASTM D-991
- 9.0 TOTAL LENGTH PER REEL MUST BE 45 METERS
- 10.0 Ⓢ CRITICAL

Dimensions in millimeters and (inches)

Ordering Information Table

Device Code																	
	<table border="1" style="margin: auto;"> <tr> <td style="padding: 5px;">42</td> <td style="padding: 5px;">C</td> <td style="padding: 5px;">T</td> <td style="padding: 5px;">Q</td> <td style="padding: 5px;">030</td> <td style="padding: 5px;">S</td> <td style="padding: 5px;">TRL</td> <td style="padding: 5px;">PbF</td> </tr> <tr> <td style="text-align: center;">①</td> <td style="text-align: center;">②</td> <td style="text-align: center;">③</td> <td style="text-align: center;">④</td> <td style="text-align: center;">⑤</td> <td style="text-align: center;">⑥</td> <td style="text-align: center;">⑦</td> <td style="text-align: center;">⑧</td> </tr> </table>	42	C	T	Q	030	S	TRL	PbF	①	②	③	④	⑤	⑥	⑦	⑧
42	C	T	Q	030	S	TRL	PbF										
①	②	③	④	⑤	⑥	⑦	⑧										
<b>1</b>	- Current Rating (40A)																
<b>2</b>	- Circuit Configuration C = Common Cathode																
<b>3</b>	- T = TO-220																
<b>4</b>	- Schottky "Q" Series																
<b>5</b>	- Voltage Rating (030 = 30V)																
<b>6</b>	- • S = D <sup>2</sup> Pak • -1 = TO-262																
<b>7</b>	- • none = Tube (50 pieces) • TRL = Tape & Reel (Left Oriented - for D <sup>2</sup> Pak only) • TRR = Tape & Reel (Right Oriented - for D <sup>2</sup> Pak only)																
<b>8</b>	- • none = Standard Production • PbF = Lead-Free																

Data and specifications subject to change without notice.  
 This product has been designed and qualified for Industrial Level and Lead-Free.  
 Qualification Standards can be found on IR's Web site.