



# 12CWQ03FNPbF

SCHOTTKY RECTIFIER

12 Amp

$I_{F(AV)} = 12\text{Amp}$   
 $V_R = 30\text{V}$

### Major Ratings and Characteristics

Characteristics	Values	Units
$I_{F(AV)}$ Rectangular waveform	12	A
$V_{RRM}$	30	V
$I_{FSM}$ @ $t_p = 5 \mu\text{s}$ sine	320	A
$V_F$ @ 6 Apk, $T_J = 125^\circ\text{C}$ (per leg)	0.37	V
$T_J$ range	-55 to 150	$^\circ\text{C}$

### Description/ Features

The 12CWQ03FNPbF surface mount, center tap, Schottky rectifier series has been designed for applications requiring low forward drop and small foot prints on PC board. Typical applications are in disk drives, switching power supplies, converters, free-wheeling diodes, battery charging, and reverse battery protection.

- Popular D-PAK outline
- Center tap configuration
- Small foot print, surface mountable
- Low forward voltage drop
- High frequency operation
- Guard ring for enhanced ruggedness and long term reliability
- Lead-Free ("PbF" suffix)

### Case Styles



D-PAK (TO-252AA)

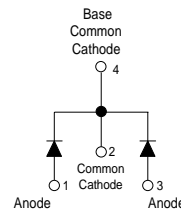

## Voltage Ratings

Part number	12CWQ03FNPbF
$V_R$ Max. DC Reverse Voltage (V)	30
$V_{RWM}$ Max. Working Peak Reverse Voltage (V)	

## Absolute Maximum Ratings

Parameters	12CWQ...	Units	Conditions
$I_{F(AV)}$ Max. Average Forward (Per Leg) Current * See Fig. 5 (Per Device)	6	A	50% duty cycle @ $T_C = 135^\circ\text{C}$ , rectangular wave form
	12		
$I_{FSM}$ Max. Peak One Cycle Non-Repetitive Surge Current (Per Leg) * See Fig. 7	320	A	5 $\mu\text{s}$ Sine or 3 $\mu\text{s}$ Rect. pulse
	130		10ms Sine or 6ms Rect. pulse
$E_{AS}$ Non-Rep. Avalanche Energy (Per Leg)	10	mJ	$T_J = 25^\circ\text{C}$ , $I_{AS} = 2.0$ Amps, $L = 5$ mH
$I_{AR}$ Repetitive Avalanche Current (Per Leg)	2.0	A	Current decaying linearly to zero in 1 $\mu\text{sec}$ Frequency limited by $T_J$ max. $V_A = 1.5 \times V_R$ typical

## Electrical Specifications

Parameters	12CWQ...	Units	Conditions
$V_{FM}$ Max. Forward Voltage Drop (Per Leg) * See Fig. 1 (1)	0.47	V	@ 6A
	0.55	V	@ 12A
	0.37	V	@ 6A
	0.49	V	@ 12A
$I_{RM}$ Max. Reverse Leakage Current (Per Leg) * See Fig. 2 (1)	3	mA	$T_J = 25^\circ\text{C}$
	58	mA	$T_J = 125^\circ\text{C}$
$V_{F(TO)}$ Threshold Voltage	0.196	V	$T_J = T_J$ max.
$r_t$ Forward Slope Resistance	21.66	m $\Omega$	
$C_T$ Typ. Junction Capacitance (Per Leg)	590	pF	$V_R = 5V_{DC}$ (test signal range 100Khz to 1Mhz) $25^\circ\text{C}$
$L_S$ Typical Series Inductance (Per Leg)	5.0	nH	Measured lead to lead 5mm from package body

(1) Pulse Width < 300 $\mu\text{s}$ , Duty Cycle <2%

## Thermal-Mechanical Specifications

Parameters	12CWQ...	Units	Conditions
$T_J$ Max. Junction Temperature Range (*)	-55 to 150	$^\circ\text{C}$	
$T_{stg}$ Max. Storage Temperature Range	-55 to 150	$^\circ\text{C}$	
$R_{thJC}$ Max. Thermal Resistance (Per Leg) Junction to Case (Per Device)	3.0	$^\circ\text{C/W}$	DC operation * See Fig. 4
	1.5		
wt Approximate Weight	0.3(0.01)	g(oz.)	
Case Style	D-Pak		Similar to TO-252AA
Marking Device	12CWQ03FN		

(\*)  $\frac{dP_{tot}}{dT_J} < \frac{1}{R_{th(j-a)}}$  thermal runaway condition for a diode on its own heatsink

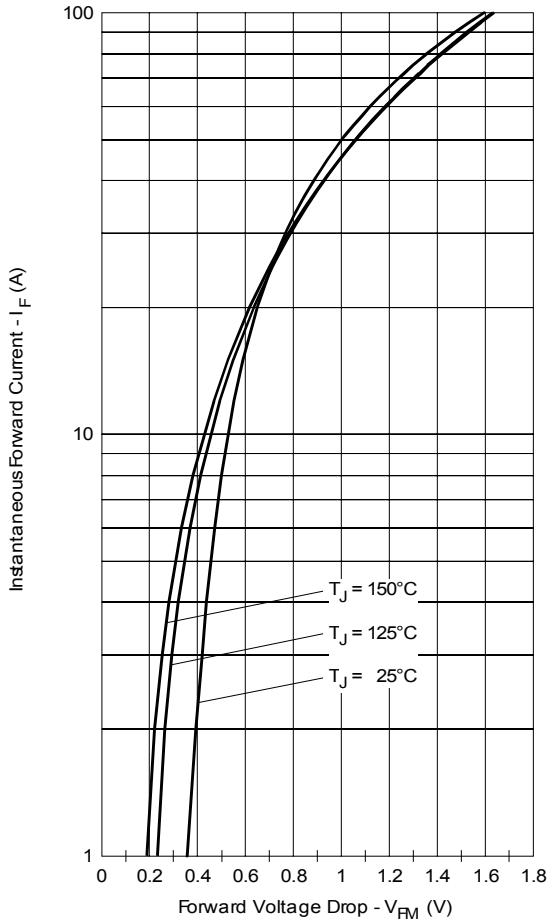

Fig. 1 - Max. Forward Voltage Drop Characteristics (Per Leg)

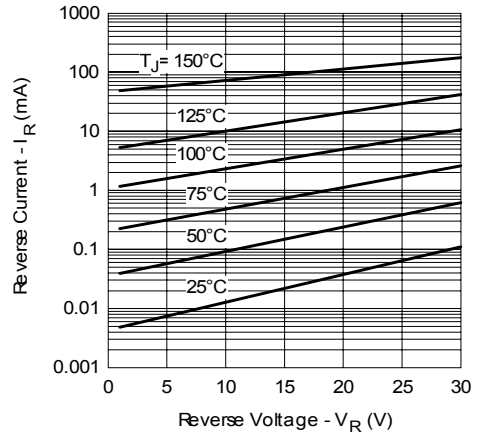

Fig. 2 - Typical Values Of Reverse Current Vs. Reverse Voltage (Per Leg)

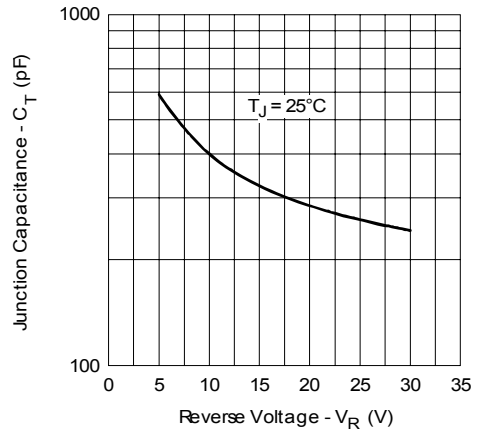

Fig. 3 - Typical Junction Capacitance Vs. Reverse Voltage (Per Leg)

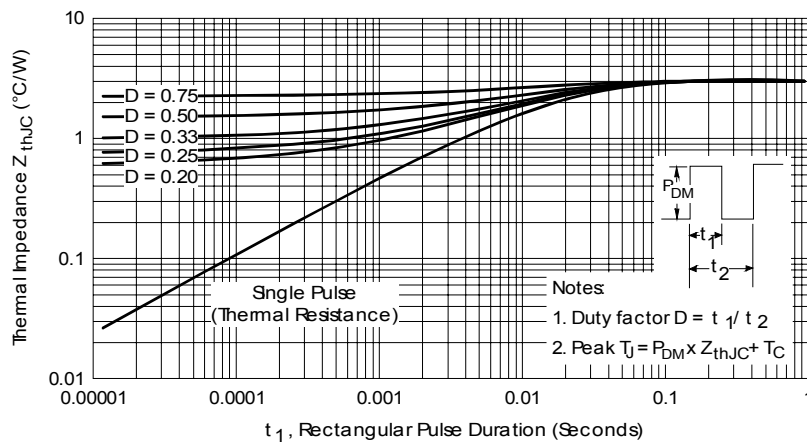

Fig. 4 - Max. Thermal Impedance  $Z_{thJC}$  Characteristics (Per Leg)

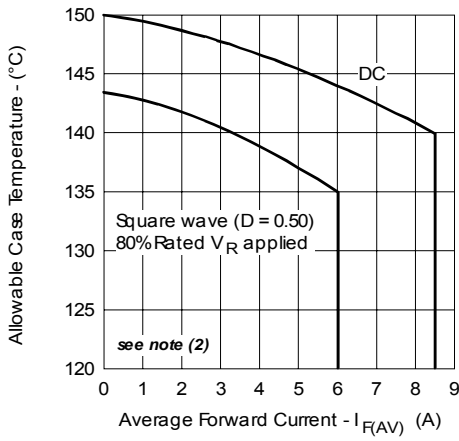

Fig. 5 - Max. Allowable Case Temperature Vs. Average Forward Current (Per Leg)

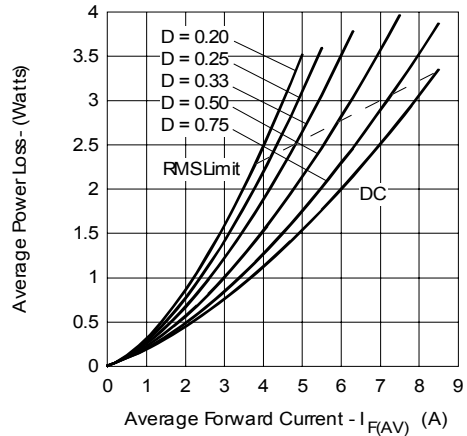

Fig. 6 - Forward Power Loss Characteristics (Per Leg)

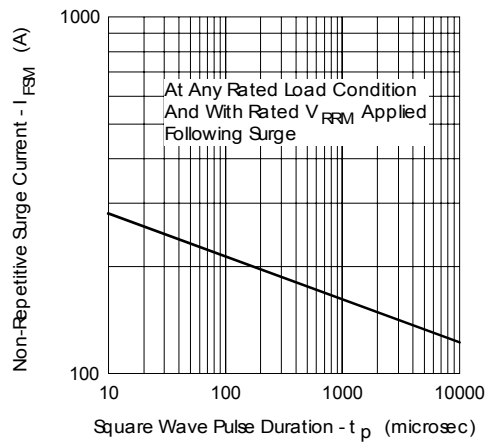

Fig. 7 - Max. Non-Repetitive Surge Current (Per Leg)

(2) Formula used:  $T_c = T_j - (Pd + Pd_{REV}) \times R_{thJC}$ ;

$Pd$  = Forward Power Loss =  $I_{F(AV)} \times V_{FM} @ (I_{F(AV)} / D)$  (see Fig. 6);

$Pd_{REV}$  = Inverse Power Loss =  $V_{R1} \times I_R (1 - D)$ ;  $I_R @ V_{R1} = 80\%$  rated  $V_R$

Outline Table

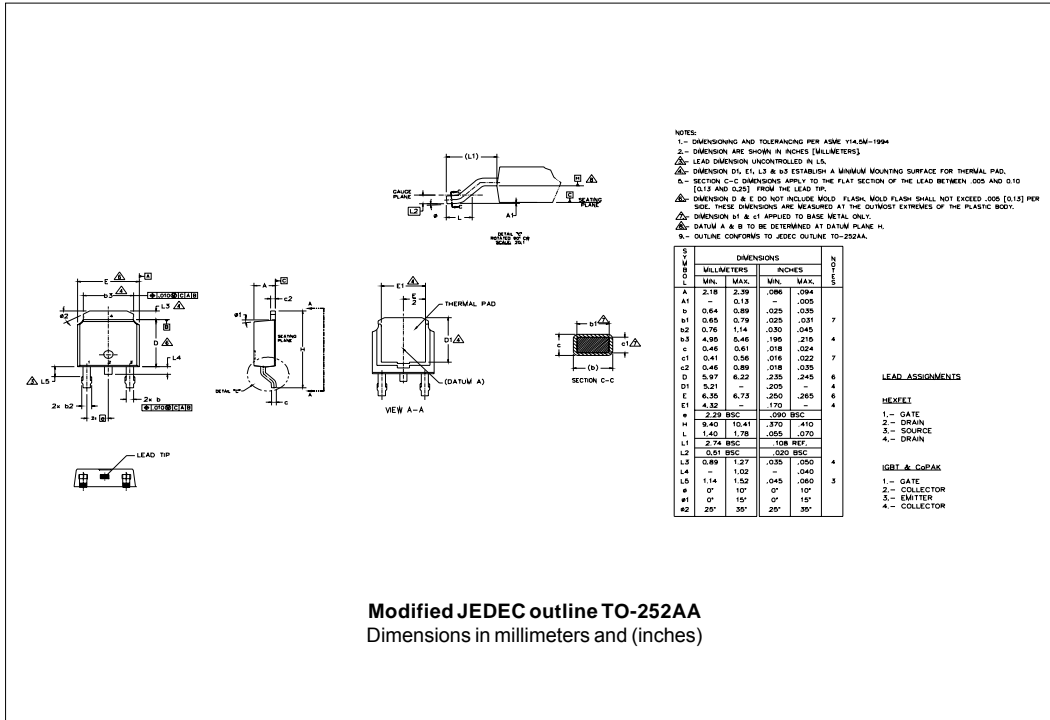

**Modified JEDEC outline TO-252AA**  
Dimensions in millimeters and (inches)

Part Marking Information

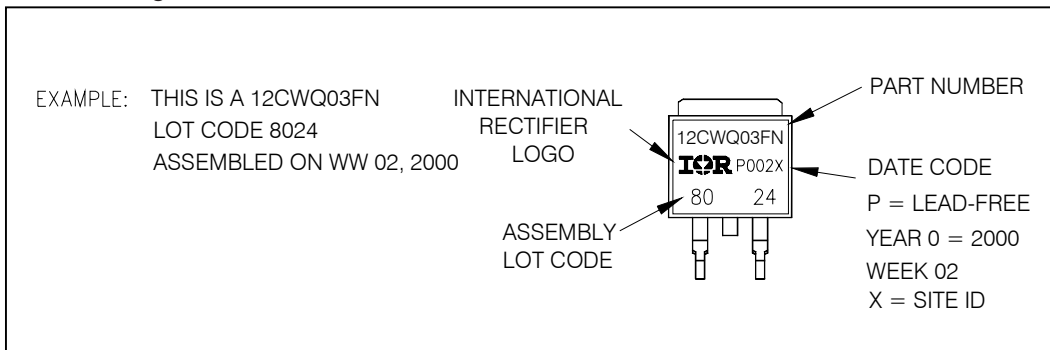

Tape & Reel Information

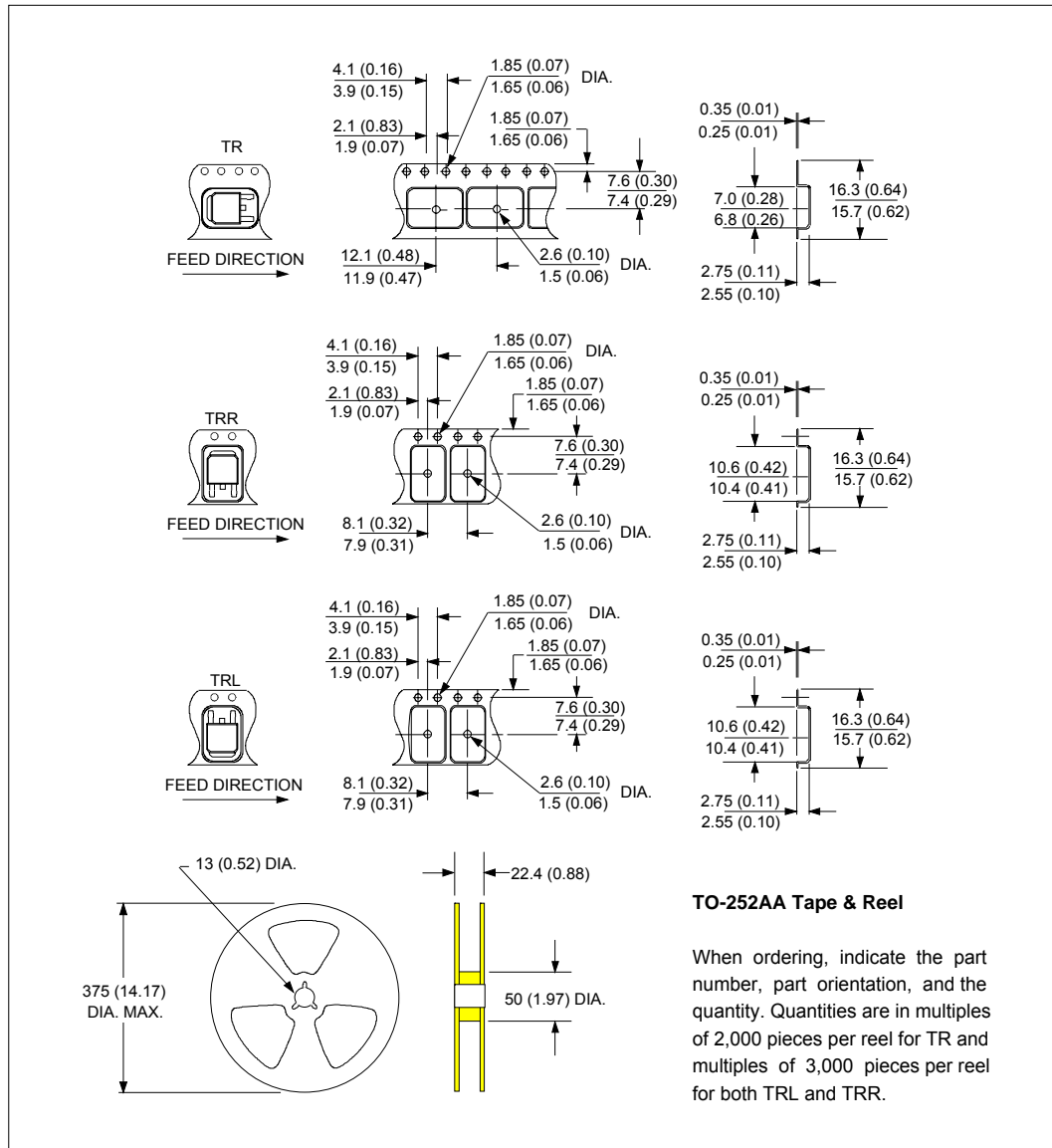

Ordering Information Table

Device Code	
<b>12</b>	<b>C</b>
①	②
<b>W</b>	<b>Q</b>
③	④
<b>03</b>	<b>FN</b>
⑤	⑥
<b>TRL</b>	<b>PbF</b>
⑦	⑧

<b>1</b>	-	Current Rating (12A)
<b>2</b>	-	Center Tap Configuration
<b>3</b>	-	Package Identifier W = D-Pak
<b>4</b>	-	Schottky "Q" Series
<b>5</b>	-	Voltage Rating (03 = 30V)
<b>6</b>	-	FN = TO-252AA
<b>7</b>	-	<ul style="list-style-type: none"> <li>• none = Tube (50 pieces)</li> <li>• TR = Tape &amp; Reel</li> <li>• TRL = Tape &amp; Reel (Left Oriented)</li> <li>• TRR = Tape &amp; Reel (Right Oriented)</li> </ul>
<b>8</b>	-	<ul style="list-style-type: none"> <li>• none = Standard Production</li> <li>• PbF = Lead-Free</li> </ul>

Data and specifications subject to change without notice.  
 This product has been designed and qualified for Consumer Level and Lead-Free.  
 Qualification Standards can be found on IR's Web site.