

IRFPS40N50LPbF

SMPS MOSFET

HEXFET® Power MOSFET

Applications

- Zero Voltage Switching SMPS
- Telecom and Server Power Supplies
- Uninterruptible Power Supplies
- Motor Control applications
- Lead-Free

V_{DSS}	$R_{DS(on)}$ typ.	T_{rr} typ.	I_D
500V	0.087 Ω	170ns	46A

Features and Benefits

- SuperFast body diode eliminates the need for external diodes in ZVS applications.
- Lower Gate charge results in simpler drive requirements.
- Enhanced dv/dt capabilities offer improved ruggedness.
- Higher Gate voltage threshold offers improved noise immunity.

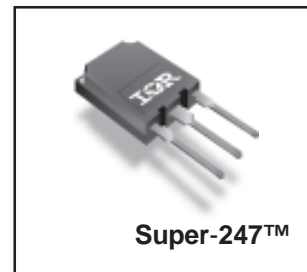

Absolute Maximum Ratings

	Parameter	Max.	Units
I_D @ $T_C = 25^\circ\text{C}$	Continuous Drain Current, $V_{GS} @ 10\text{V}$	46	A
I_D @ $T_C = 100^\circ\text{C}$	Continuous Drain Current, $V_{GS} @ 10\text{V}$	29	
I_{DM}	Pulsed Drain Current ①	180	
P_D @ $T_C = 25^\circ\text{C}$	Power Dissipation	540	W
	Linear Derating Factor	4.3	W/°C
V_{GS}	Gate-to-Source Voltage	± 30	V
dv/dt	Peak Diode Recovery dv/dt ②	34	V/ns
T_J	Operating Junction and	-55 to +150	°C
T_{STG}	Storage Temperature Range		
	Soldering Temperature, for 10 seconds	300 (1.6mm from case)	

Diode Characteristics

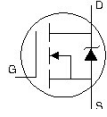
Symbol	Parameter	Min.	Typ.	Max.	Units	Conditions
I_S	Continuous Source Current (Body Diode)	—	—	46	A	MOSFET symbol showing the integral reverse p-n junction diode. 
I_{SM}	Pulsed Source Current (Body Diode) ①	—	—	180		
V_{SD}	Diode Forward Voltage	—	—	1.5	V	$T_J = 25^\circ\text{C}$, $I_S = 46\text{A}$, $V_{GS} = 0\text{V}$ ④
t_{rr}	Reverse Recovery Time	—	170	250	ns	$T_J = 25^\circ\text{C}$, $I_F = 46\text{A}$
		—	220	330		$T_J = 125^\circ\text{C}$, $di/dt = 100\text{A}/\mu\text{s}$ ④
Q_{rr}	Reverse Recovery Charge	—	705	1060	nC	$T_J = 25^\circ\text{C}$, $I_S = 46\text{A}$, $V_{GS} = 0\text{V}$ ④
		—	1.3	2.0		$T_J = 125^\circ\text{C}$, $di/dt = 100\text{A}/\mu\text{s}$ ④
I_{RRM}	Reverse Recovery Current	—	9.0	—	A	$T_J = 25^\circ\text{C}$
t_{on}	Forward Turn-On Time	Intrinsic turn-on time is negligible (turn-on is dominated by LS+LD)				

IRFPS40N50LPbF

International
IR Rectifier

Static @ $T_J = 25^\circ\text{C}$ (unless otherwise specified)

Symbol	Parameter	Min.	Typ.	Max.	Units	Conditions
$V_{(BR)DSS}$	Drain-to-Source Breakdown Voltage	500	—	—	V	$V_{GS} = 0V, I_D = 250\mu A$
$\Delta V_{(BR)DSS}/\Delta T_J$	Breakdown Voltage Temp. Coefficient	—	0.60	—	V/°C	Reference to $25^\circ\text{C}, I_D = 1\text{mA}$
$R_{DS(on)}$	Static Drain-to-Source On-Resistance	—	0.087	0.100	Ω	$V_{GS} = 10V, I_D = 28A$ ④
$V_{GS(th)}$	Gate Threshold Voltage	3.0	—	5.0	V	$V_{DS} = V_{GS}, I_D = 250\mu A$
I_{DSS}	Drain-to-Source Leakage Current	—	—	50	μA	$V_{DS} = 500V, V_{GS} = 0V$
		—	—	2.0	mA	$V_{DS} = 400V, V_{GS} = 0V, T_J = 125^\circ\text{C}$
I_{GSS}	Gate-to-Source Forward Leakage	—	—	100	nA	$V_{GS} = 30V$
	Gate-to-Source Reverse Leakage	—	—	-100	nA	$V_{GS} = -30V$
R_G	Internal Gate Resistance	—	0.90	—	Ω	$f = 1\text{MHz}$, open drain

Dynamic @ $T_J = 25^\circ\text{C}$ (unless otherwise specified)

Symbol	Parameter	Min.	Typ.	Max.	Units	Conditions
g_{fs}	Forward Transconductance	21	—	—	S	$V_{DS} = 50V, I_D = 46A$
Q_g	Total Gate Charge	—	—	380	nC	$I_D = 46A$ $V_{DS} = 400V$ $V_{GS} = 10V$, See Fig. 7 & 15 ④
Q_{gs}	Gate-to-Source Charge	—	—	80		
Q_{gd}	Gate-to-Drain ("Miller") Charge	—	—	190		
$t_{d(on)}$	Turn-On Delay Time	—	27	—	ns	$V_{DD} = 250V$ $I_D = 46A$ $R_G = 0.85\Omega$ $V_{GS} = 10V$, See Fig. 14a & 14b ④
t_r	Rise Time	—	170	—		
$t_{d(off)}$	Turn-Off Delay Time	—	50	—		
t_f	Fall Time	—	69	—		
C_{iss}	Input Capacitance	—	8110	—	pF	$V_{GS} = 0V$ $V_{DS} = 25V$ $f = 1.0\text{MHz}$, See Fig. 5 $V_{GS} = 0V, V_{DS} = 1.0V, f = 1.0\text{MHz}$ $V_{GS} = 0V, V_{DS} = 400V, f = 1.0\text{MHz}$ $V_{GS} = 0V, V_{DS} = 0V$ to $400V$ ⑤
C_{oss}	Output Capacitance	—	960	—		
C_{riss}	Reverse Transfer Capacitance	—	130	—		
C_{oss}	Output Capacitance	—	11200	—		
C_{oss}	Output Capacitance	—	240	—		
$C_{oss\ eff.}$	Effective Output Capacitance	—	440	—		
$C_{oss\ eff. (ER)}$	Effective Output Capacitance (Energy Related)	—	310	—		

Avalanche Characteristics

Symbol	Parameter	Typ.	Max.	Units
E_{AS}	Single Pulse Avalanche Energy ⑥	—	920	mJ
I_{AR}	Avalanche Current ①	—	46	A
E_{AR}	Repetitive Avalanche Energy ①	—	54	mJ

Thermal Resistance

Symbol	Parameter	Typ.	Max.	Units
$R_{\theta JC}$	Junction-to-Case ⑥	—	0.23	°C/W
$R_{\theta CS}$	Case-to-Sink, Flat, Greased Surface	0.24	—	
$R_{\theta JA}$	Junction-to-Ambient ⑥	—	40	

Notes:

- ① Repetitive rating; pulse width limited by max. junction temperature. (See Fig. 11).
- ② Starting $T_J = 25^\circ\text{C}$, $L = 0.86\text{mH}$, $R_G = 25\Omega$, $I_{AS} = 46A$. (See Figure 12).
- ③ $I_{SD} \leq 46A$, $di/dt \leq 550A/\mu s$, $V_{DD} \leq V_{(BR)DSS}$, $T_J \leq 150^\circ\text{C}$.

④ Pulse width $\leq 400\mu s$; duty cycle $\leq 2\%$.

- ⑤ $C_{oss\ eff.}$ is a fixed capacitance that gives the same charging time as C_{oss} while V_{DS} is rising from 0 to $80\% V_{DSS}$.
 $C_{oss\ eff. (ER)}$ is a fixed capacitance that stores the same energy as C_{oss} while V_{DS} is rising from 0 to $80\% V_{DSS}$.

⑥ R_{θ} is measured at T_J approximately 90°C

IRFPS40N50LPbF

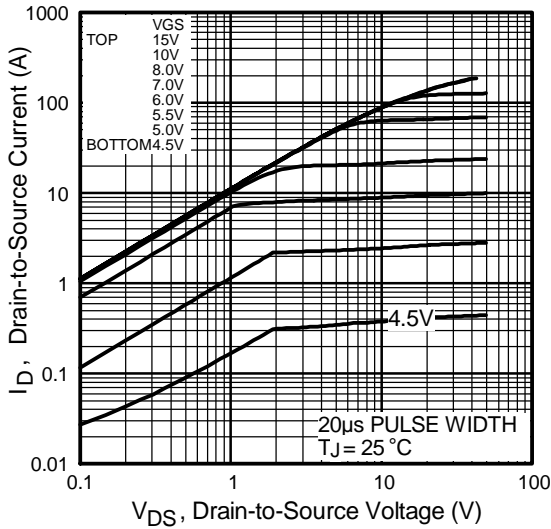

Fig 1. Typical Output Characteristics

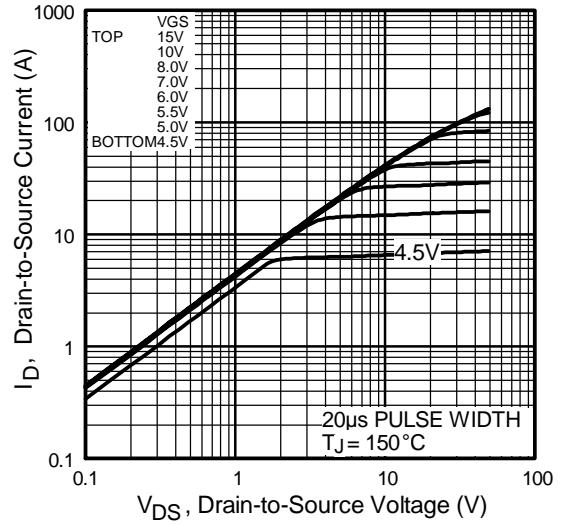

Fig 2. Typical Output Characteristics

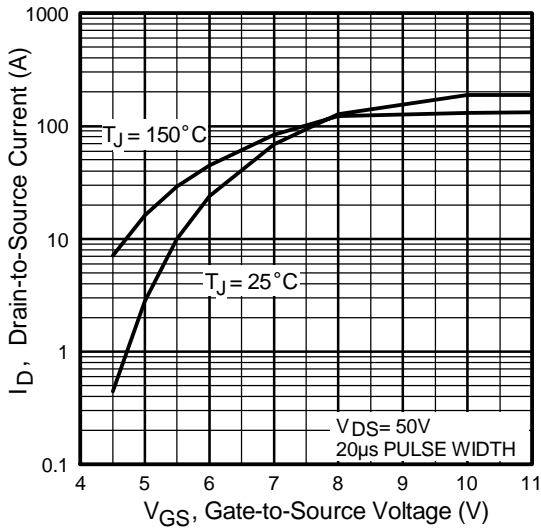

Fig 3. Typical Transfer Characteristics

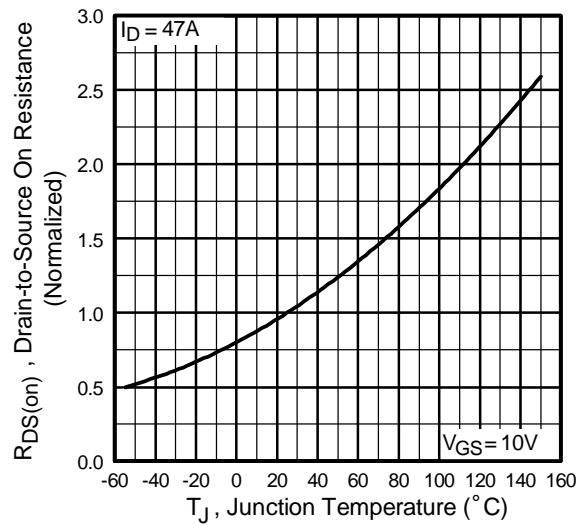

Fig 4. Normalized On-Resistance vs. Temperature

IRFPS40N50LPbF

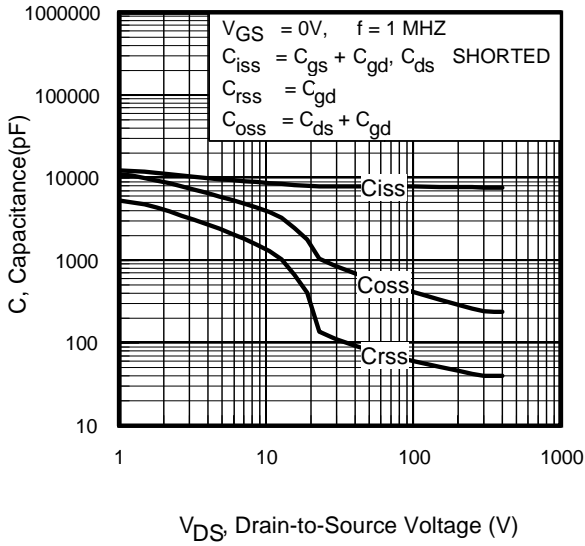

Fig 5. Typical Capacitance vs. Drain-to-Source Voltage

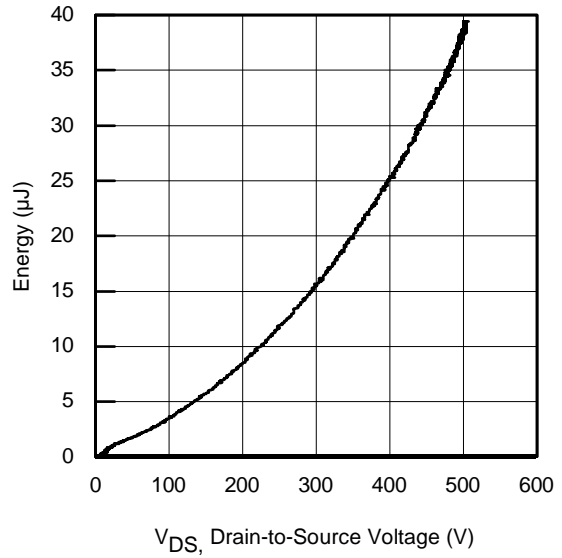

Fig 6. Typ. Output Capacitance Stored Energy vs. V_{DS}

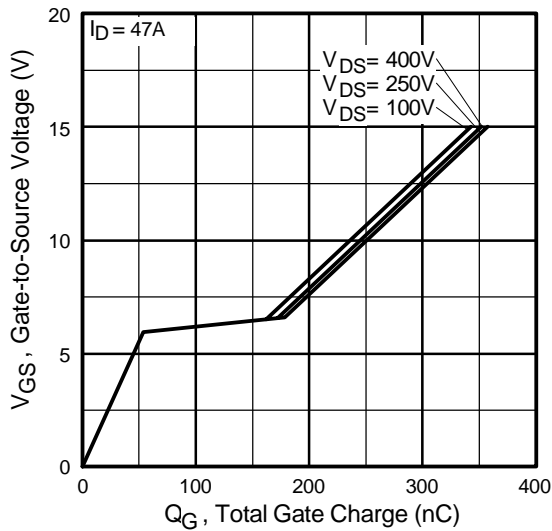

Fig 7. Typical Gate Charge vs. Gate-to-Source Voltage

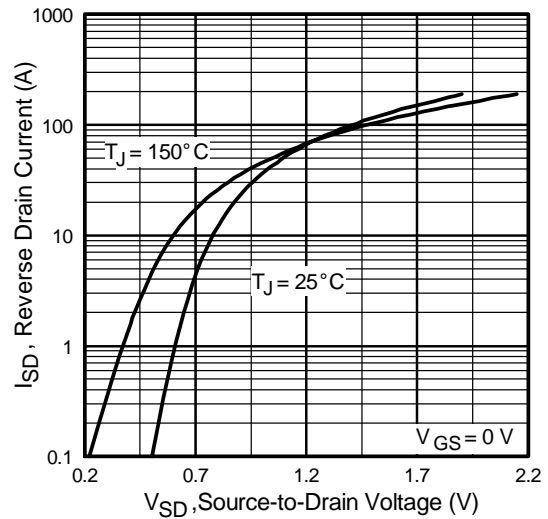

Fig 8. Typical Source-Drain Diode Forward Voltage

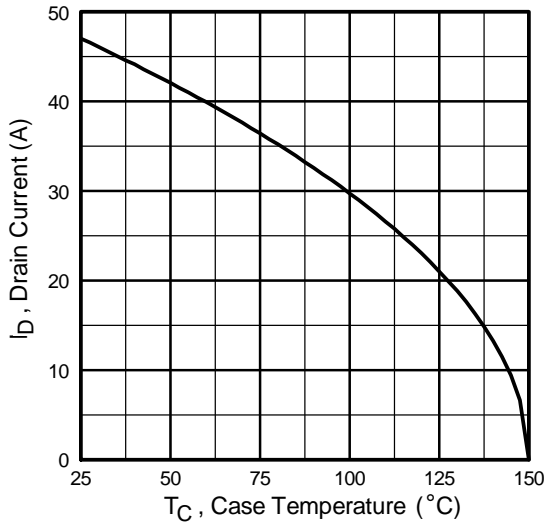

Fig 9. Maximum Drain Current vs. Case Temperature

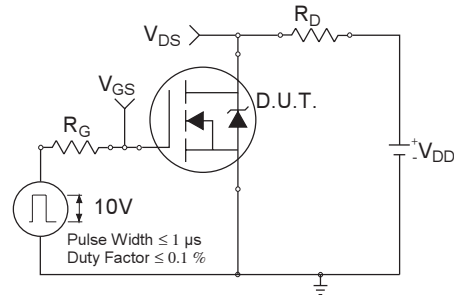

Fig 10a. Switching Time Test Circuit

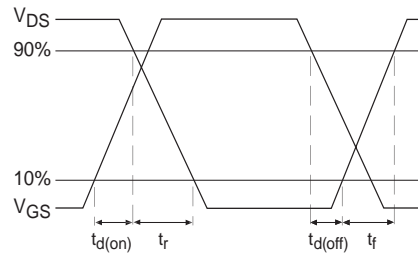

Fig 10b. Switching Time Waveforms

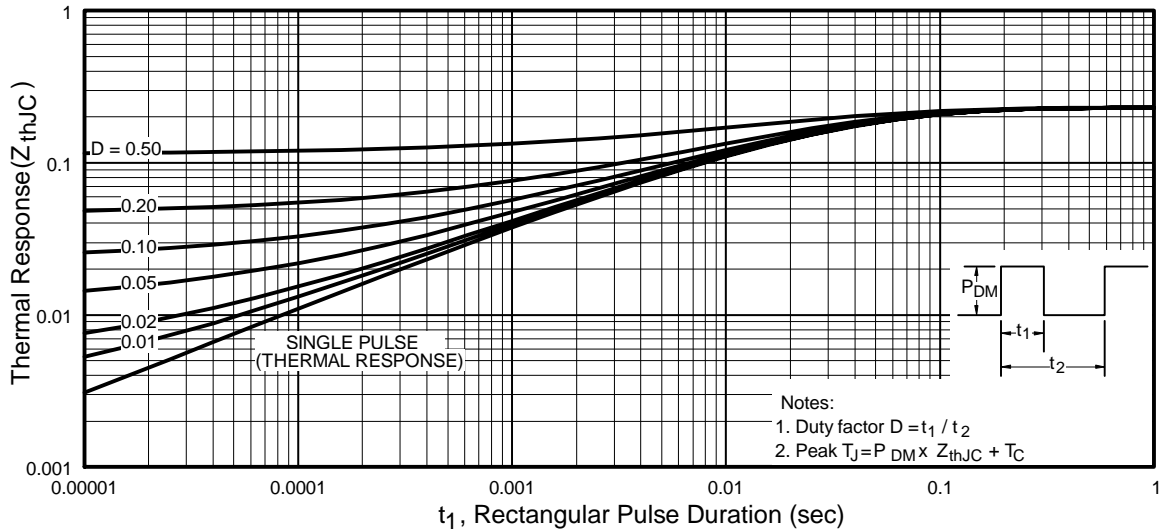

Fig 11. Maximum Effective Transient Thermal Impedance, Junction-to-Case

IRFPS40N50LPbF

International
IR Rectifier

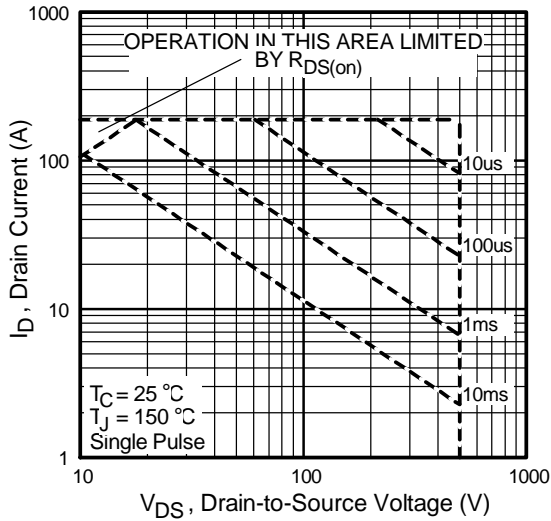

Fig 12. Maximum Safe Operating Area

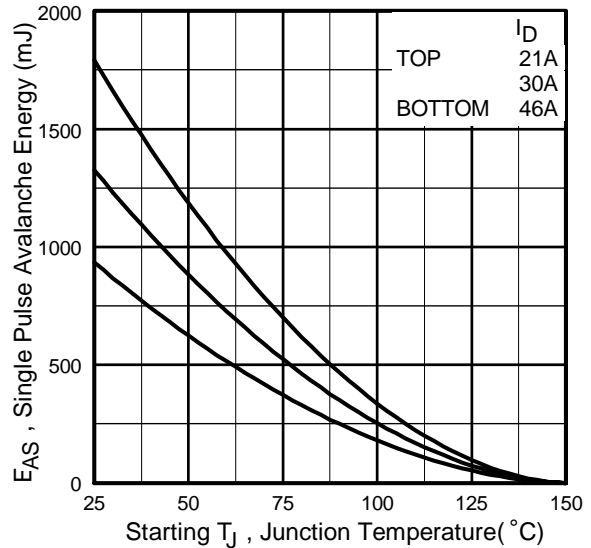

Fig 13. Maximum Avalanche Energy vs. Drain Current

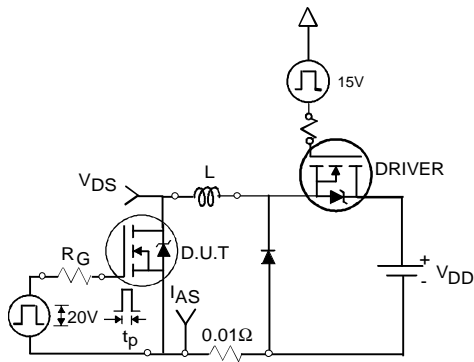

Fig 14a. Unclamped Inductive Test Circuit

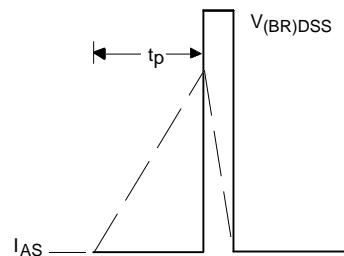

Fig 14b. Unclamped Inductive Waveforms

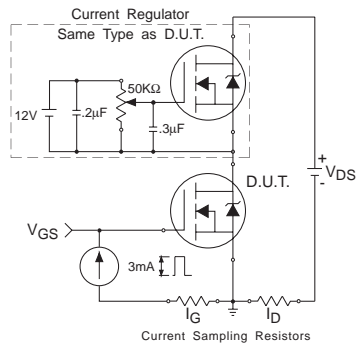

Fig 15a. Gate Charge Test Circuit

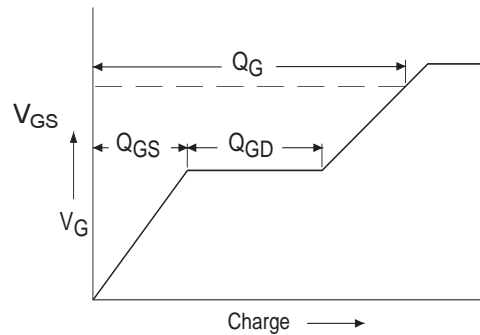
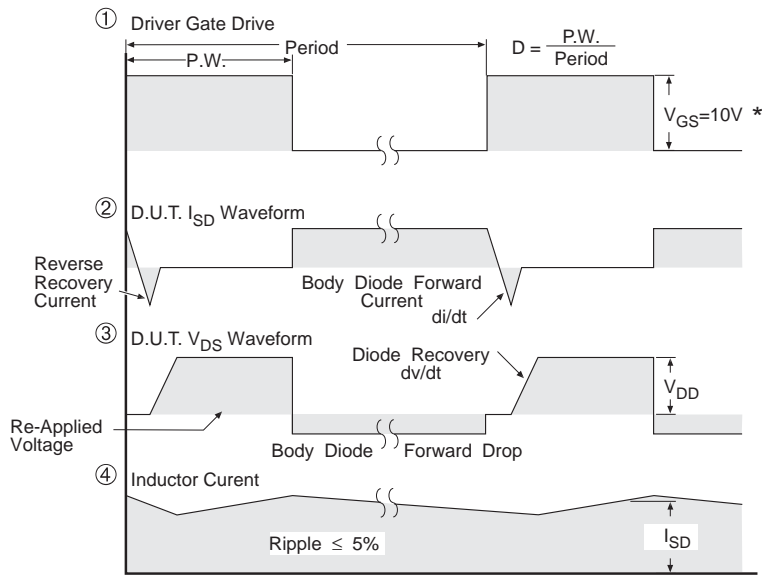
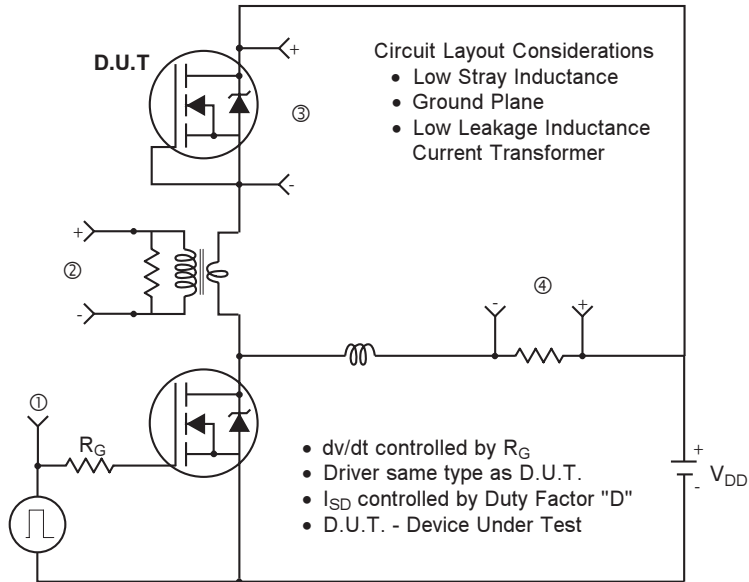

Fig 15b. Basic Gate Charge Waveform
www.irf.com

Peak Diode Recovery dv/dt Test Circuit



* $V_{GS} = 5V$ for Logic Level Devices

Fig 16. For N-Channel HEXFET® Power MOSFETs

IRFPS40N50LPbF Case Outline and Dimensions — Super-247

International
IR Rectifier

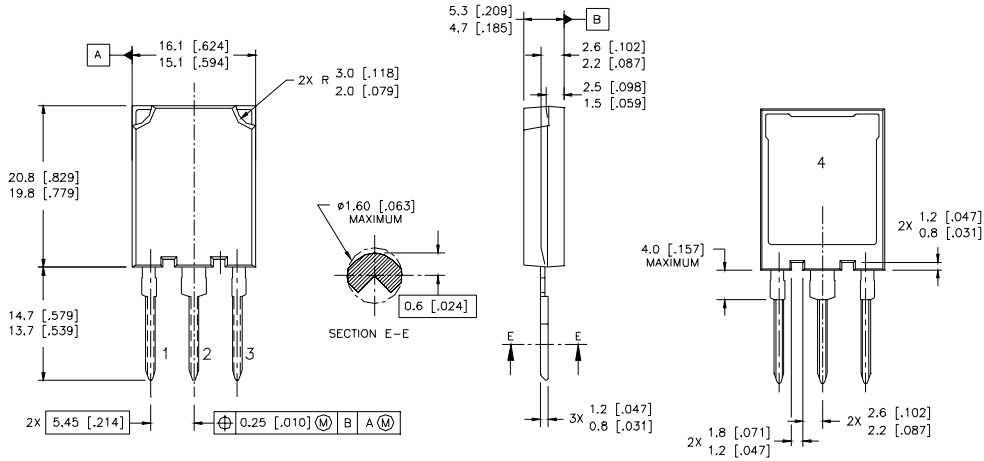

- NOTES:
1. DIMENSIONS & TOLERANCING PER ASME Y14.5M-1994
 2. CONTROLLING DIMENSION: MILLIMETER
 3. DIMENSIONS ARE SHOWN IN MILLIMETRES [INCHES]

LEAD ASSIGNMENTS

MOSFET	IGBT
1 - GATE	1 - GATE
2 - DRAIN	2 - COLLECTOR
3 - SOURCE	3 - EMITTER
4 - DRAIN	4 - COLLECTOR

Super-247 (TO-274AA) Part Marking Information

EXAMPLE: THIS IS AN IRFPS37N50A WITH
ASSEMBLY LOT CODE 1789
ASSEMBLED ON WW 19, 1997
IN THE ASSEMBLY LINE "C"

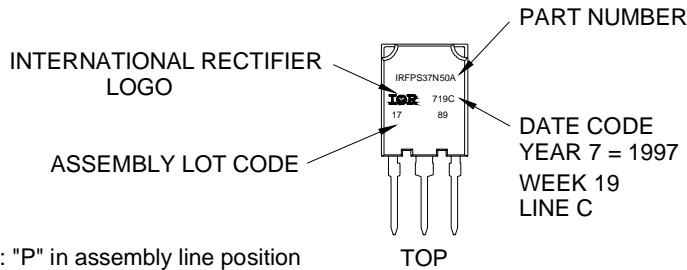

Data and specifications subject to change without notice.
This product has been designed and qualified for the industrial market.
Qualification Standards can be found on IR's Web site.

International
IR Rectifier

IR WORLD HEADQUARTERS: 233 Kansas St., El Segundo, California 90245, USA Tel: (310) 252-7105
TAC Fax: (310) 252-7903

Visit us at www.irf.com for sales contact information.09/04

www.irf.com