



# AKD4563A

## Evaluation board Rev.A for AK4563A

### GENERAL DESCRIPTION

AKD4563A is an evaluation board for the 16bit 4ch A/D and 2ch D/A converter, AK4563A. The AKD4563A can evaluate A/D converter D/A converter separately in addition to loopback mode (A/D → D/A). The A/D section can be evaluated by interfacing with AKM's DAC evaluation boards directly. The AKD4563A has the interface with AKM's ADC evaluation boards. Therefore, it's easy to evaluate the D/A section. The AKD4563A also has the digital audio interface and can achieve the interface with digital audio systems via opt-connector.

■ **Ordering guide**

AKD4563A --- Evaluation board for AK4563A  
 (Cable for connecting with printer port of IBM-AT,  
 compatible PC and control software are packed with this.)

### FUNCTION

- **Compatible with 2 types of interface**
  - Direct interface with AKM's A/D & D/A converter evaluation boards
  - DIT/DIR with optical input/output
- **BNC connector for an external clock input**
- **10pin Header for serial control mode**

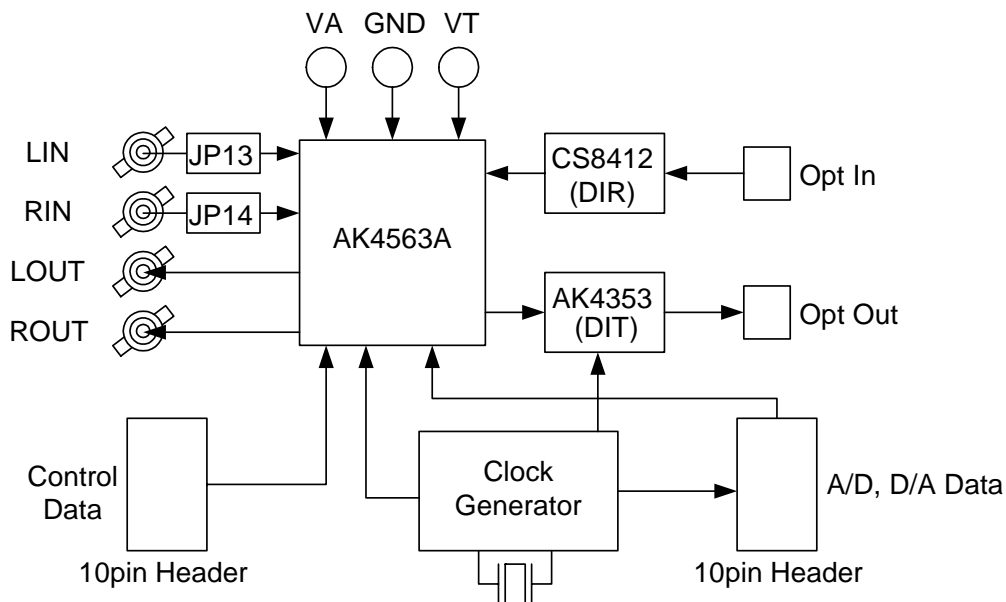

Figure 1. AKD4563A Block Diagram

\* Circuit diagram and PCB layout are attached at the end of this manual.

**Evaluation Board Manual**

■ **Input / Output circuits & Set-up jumper pin for Input / Output circuits**

(1) Input circuits

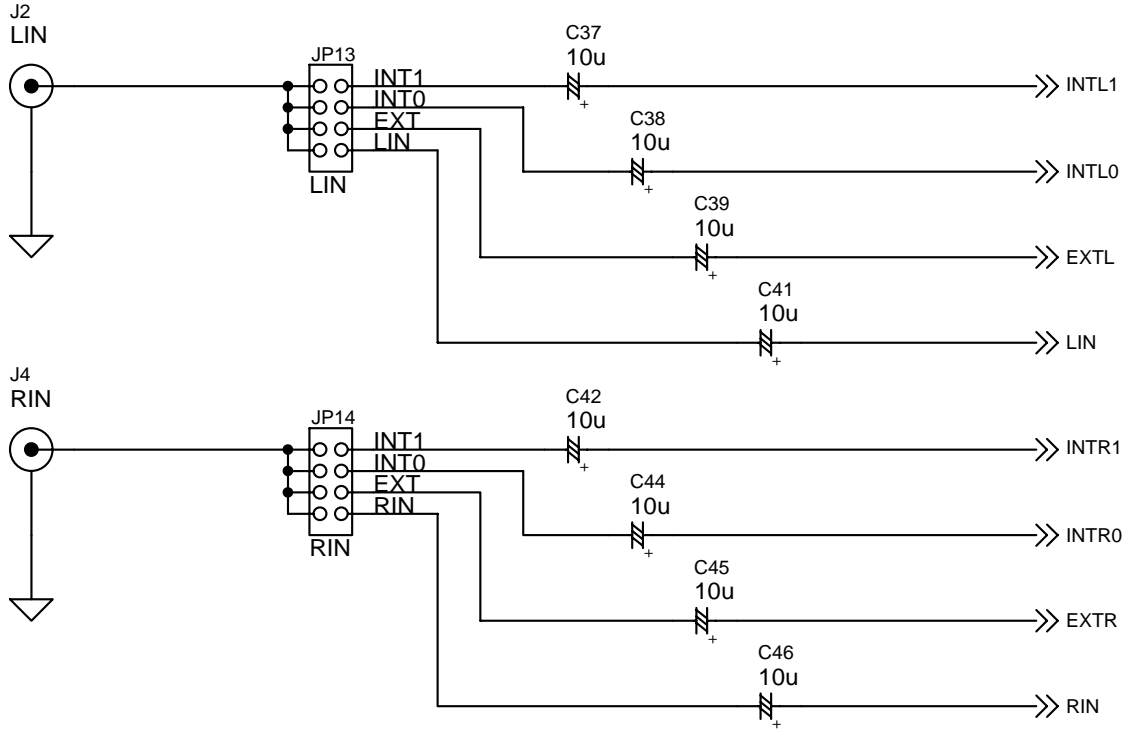
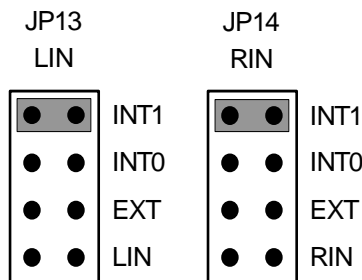
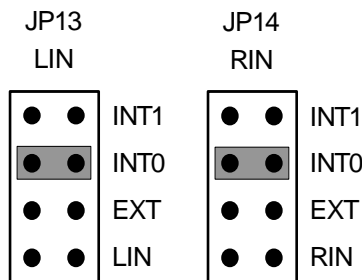

Figure 2. LIN/RIN Input circuits

1. Analog signal is input to INTL1 and INTR1 pins via J2 and J4 connectors.



2. Analog signal is input to INTL0 and INTR0 pins via J2 and J4 connectors.



3. Analog signal is input to EXTL and EXTR pins via J2 and J4 connectors.

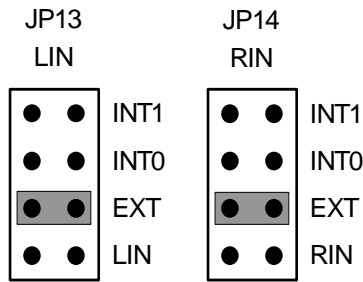

4. Analog signal is input to LIN and RIN pins via J2 and J4 connectors.

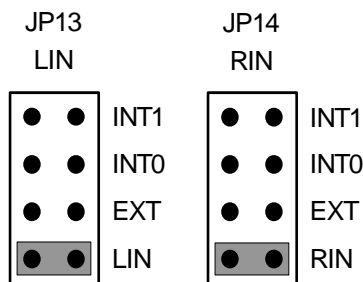

(2) Output circuits

Analog signal is output to LOUT and ROUT pins via J3 and J5 connectors.

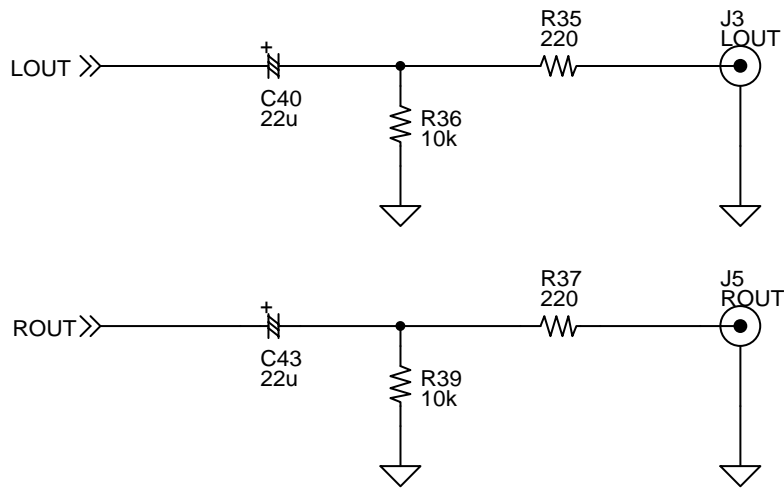

Figure 3. LOUT/ROUT output circuits

\* AKM assumes no responsibility for the trouble when using the above circuit examples.

■ Operation sequence

1) Set up the power supply lines.

- [VA] (orange) = 2.3 ~ 3.0V : for VA of AK4563A (typ. 2.5V)
- [VT] (orange) = 1.5 ~ 3.0V : for VT of AK4563A (typ. 2.5V)
- [D2V] (orange) = 1.5 ~ 3.0V : for 74LVC541 (typ. 2.5V)
- [D5V] (red) = 3.6 ~ 5.0V : for logic (typ. 5.0V)
- [AGND] (black) = 0V : for analog ground
- [DGND] (black) = 0V : for logic ground

Each supply line should be distributed from the power supply unit.  
VT and D2V must be same voltage level.

2) Set up the evaluation mode, jumper pins and DIP switches. (See the followings.)

3) Power on.

The AK4563A and AK4353 should be reset once bringing SW1, 2 “L” upon power-up.

■ Evaluation mode

Applicable Evaluation Mode

- 1) Evaluation of loopback mode (default)
- 2) Evaluation of D/A using A/D converted data
- 3) Evaluation of D/A using DIR (Optical Link)
- 4) Evaluation of A/D using D/A converted data
- 5) Evaluation of A/D using DIT (Optical Link)
- 6) All interface signals including master clock are fed externally.

1) Evaluation of loopback mode. <default>

Nothing should be connected to PORT3 and PORT4. In case of using external clock through a BNC connector (J1), select EXT on JP11 (CLK) and short JP12 (XTE). When SDTO0 is connected with SDTI, JP8 (SD0/1) selects SD0 side. When SDTO1 is connected with SDTI, JP8 (SD0/1) selects SD1 side.

Table 1. AK4563A audio data I/F format and Setting JP3

AK4563A				JP3
DIF1	DIF0	SDTO0/SDTO1 (ADC)	SDTI (DAC)	(X_BCLK)
0	0	16bit MSB justified	16bit LSB justified	32fs
0	1	16bit LSB justified	16bit LSB justified	64fs
1	0	16bit MSB justified	16bit MSB justified	32fs or 64fs
1	1	I <sup>2</sup> S Compatible	I <sup>2</sup> S Compatible	32fs or 64fs

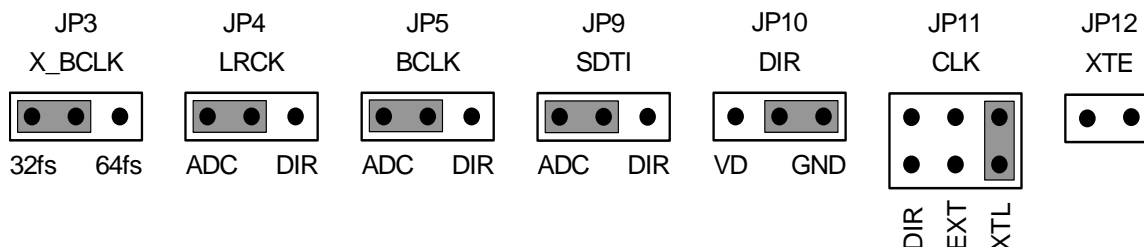

2) Evaluation of D/A using A/D converted data.

It is possible to make evaluation in the form of analog inputs and analog outputs by interfacing with various AKM's A/D evaluation boards with PORT3. Nothing should be connected to PORT1, PORT4. In case of using external clock through a BNC connector (J1), select EXT on JP11 (CLK) and short JP12 (XTE).

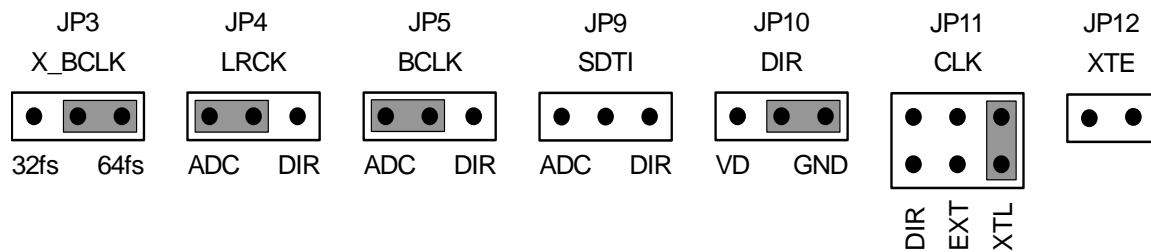

3) Evaluation of D/A using DIR. (Optical link)

PORT4 (DIR) is used. DIR generates MCLK, BCLK, LRCK and SDATA from the received data through optical connector (TORX176). Used for the evaluation using CD test disk. Nothing should be connected to PORT1, PORT3.

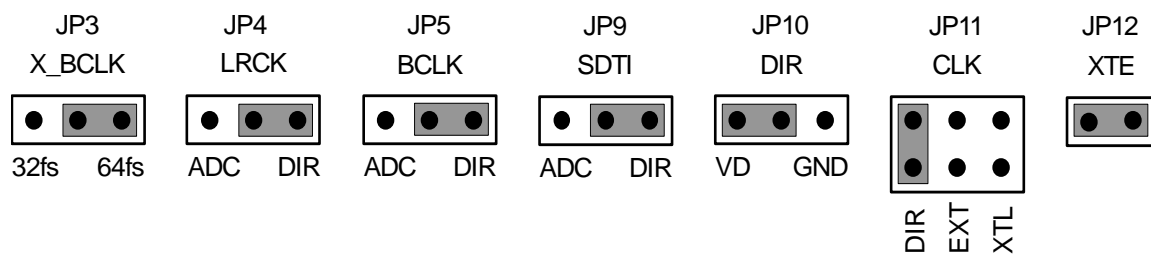

4) Evaluation of A/D using D/A converted data.

It is possible to make evaluation in the form of analog inputs and analog outputs by interfacing with various AKM's D/A evaluation boards with PORT3. Nothing should be connected to PORT4. When SDTO0 is supplied from PORT1, JP8 (SD0/1) selects SD0 side. When SDTO1 is supplied from PORT1, JP8 (SD0/1) selects SD1 side.

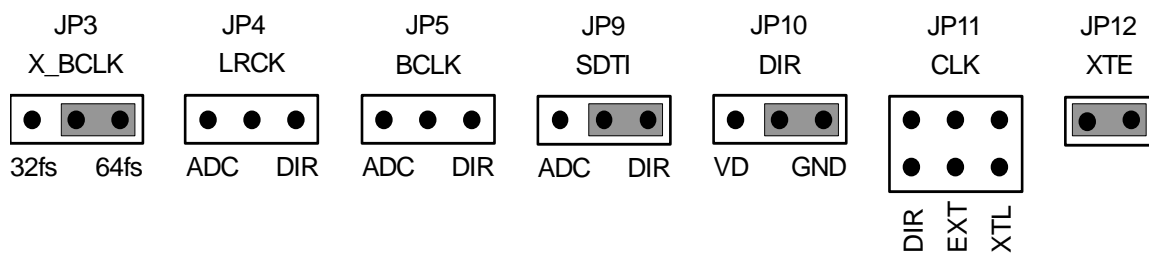

5) Evaluation of A/D using DIT. (Optical link)

PORT1 (DIT) is used. DIT generates audio bi-phase signal from received data and which is output through optical connector (TOTX176). It is possible to connect AKM's D/A converter evaluation boards on the digital-amplifier which equips DIR input. Nothing should be connected PORT3 and PORT4. In case of using external clock through a BNC connector (J1), select EXT on JP11 (CLK) and short JP12 (XTE). When SDTO0 is supplied from PORT1, JP8 (SD0/1) selects SD0 side. When SDTO1 is supplied from PORT1, JP8 (SD0/1) selects SD1 side.

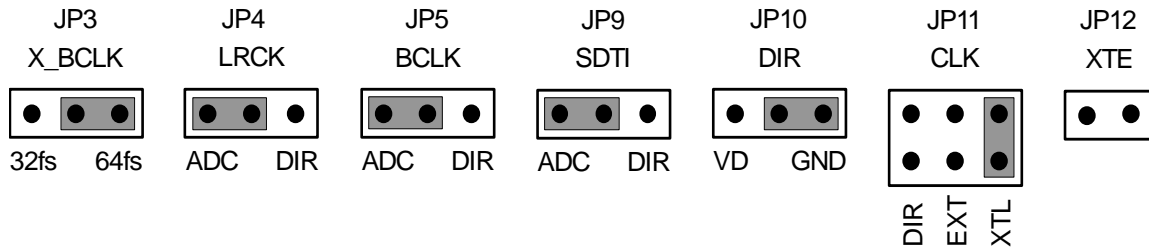

6) All interfacing signals (MCLK, BCLK, LRCK) are fed from the external circuit through PORT3.

Under the following set up, all external signals needed for the AK4563A to operate could be fed through PORT3. In case of interfacing external sources to D/A converter, JP7 (SDTO) should be open. And in case of using A/D data to externally, JP9 (SDTI) is set ADC side. When JP9 (SDTI) is open, the A/D data can be output from the PORT3, if JP7 (SDTO) is short.

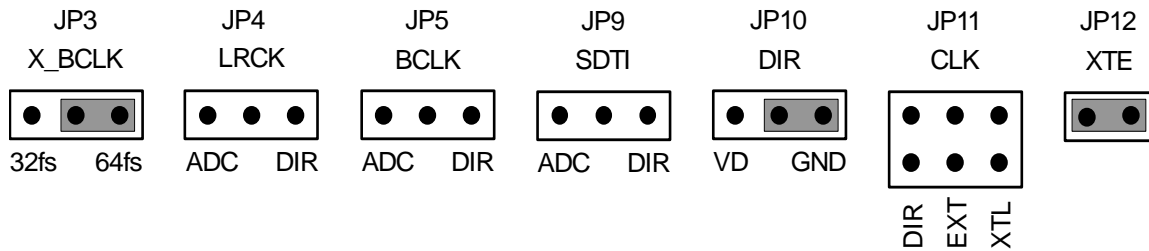

## ■ DIP Switch set up

[SW3] (MODE): Setting evaluation mode of CS8412(DIR)  
ON is “1”, OFF is “0”.

Table 2. AK4563A audio data I/F format and setting SW3 and JP6

AK4563A		MODE	SW3			JP6
DIF1	DIF0		M0	M1	M2	
0	0	16bit LSB justified	1	0	1	THR
0	1	16bit LSB justified	1	0	1	THR
1	0	16bit MSB justified	0	0	0	INV
1	1	I <sup>2</sup> S Compatible	0	1	0	THR

SW3 and AK4563A format must be same audio data format.

## ■ Other jumper pins set up

1. JP1 (GND) : Analog ground and Digital ground  
OPEN : Separated.  
SHORT: Common. (The connector “DGND” can be open.) <default>
2. JP2 (VT) : D2V and VT  
OPEN : Separated. <default>  
SHORT: Common. (The connector “VT” can be open.)
3. JP6 (PHASE) : Phase of BCLK using DIR  
THR : BCLK is coincides with AK4563A. (16bit LSB justified and I<sup>2</sup>S compatible for DAC.)  
INV : BCLK is inverted. (16bit MSB justified for DAC.)
4. JP7 (SDTO) : Analog ground and Digital ground  
\*Always open.
5. JP8 (SD0/1) : Select SDTO0 or SDTO1  
SD0 : Select SDTO0.  
SD1 : Select SDTO1.

## ■ The function of the toggle SW

Upper-side is “H” and lower-side is “L”.

[SW1] (PDN): Power down of AK4563A. Keep “H” during normal operation.

[SW2] (DIT): Power down of AK4353. Keep “H” during normal operation.

## ■ Indication for LED

[LED1] (VERF): Monitor VERF pin of the CS8412. LED turns on when some error has occurred to CS8412.

[LED2] (PREM): Indicate whether the input data of CS8412 is pre-emphasized or not.

■ **Serial Control**

The AK4563A can be controlled via the printer port (parallel port) of IBM-AT compatible PC. Connect PORT2 (CTRL) with PC by 10 wire flat cable packed with the AKD4563A.

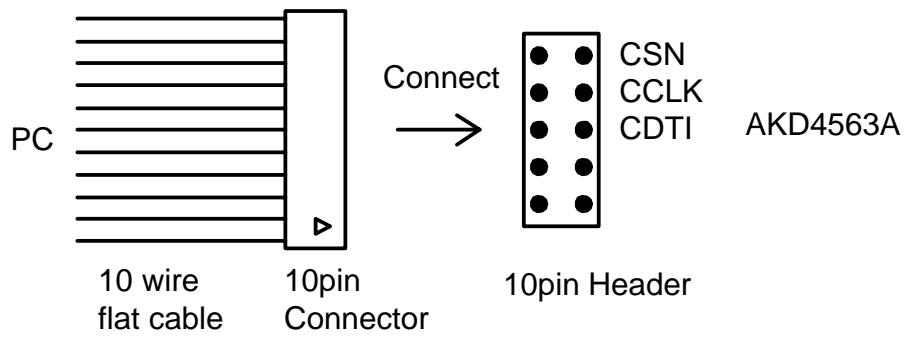

Figure 4. Connect of 10 wire flat cable



## Control Software Manual

### ■ Set-up of evaluation board and control software

1. Set up the AKD4563A according to previous term.
2. Connect IBM-AT compatible PC with AKD4563A by 10-line type flat cable (packed with AKD4563A). Take care of the direction of 10pin header. (Please install the driver in the CD-ROM when this control software is used on Windows 2000/XP. Please refer “Installation Manual of Control Software Driver by AKM device control software”. In case of Windows95/98/ME, this installation is not needed. This control software does not operate on Windows NT.)
3. Insert the CD-ROM labeled “AK4563A Evaluation Kit” into the CD-ROM drive.
4. Access the CD-ROM drive and double-click the icon of “akd4563A.exe” to set up the control program.
5. Then please evaluate according to the follows.

### ■ Operation flow

Keep the following flow.

1. Set up the control program according to explanation above.
2. Click “Port Setup” button.
3. Click “Write default” button.
4. Then set up the dialog and input data.

### ■ Explanation of each buttons

- |                      |                                                                                                                 |
|----------------------|-----------------------------------------------------------------------------------------------------------------|
| 1. [Port Reset] :    | Set up the port. When this is pushed, the printer port or USB port is selected automatically.                   |
| 2. [Write default] : | Initialize the register of the AK4563A                                                                          |
| 3. [All Read] :      | Read all registers of the AK4563A.                                                                              |
| 4. [All Write] :     | Write all registers that is currently displayed                                                                 |
| 5. [Function1] :     | Dialog to write data by keyboard operation.                                                                     |
| 6. [Function2] :     | Dialog to evaluate IPGA and ATTL/ATTR.                                                                          |
| 7. [Function3] :     | The sequence of register setting can be set and executed.                                                       |
| 8. [Function4] :     | The sequence that is created on [Function3] can be assigned to buttons and executed.                            |
| 9. [Function5] :     | The register setting that is created by [SAVE] function on main window can be assigned to buttons and executed. |
| 10.[Write] :         | Dialog to write data by mouse operation.                                                                        |
| 11.[Read] :          | Read data by mouse operation.                                                                                   |
| 12.[SAVE] :          | Save the current register setting.                                                                              |
| 13.[OPEN] :          | Write the save values to all register.                                                                          |
| 14.[AK4353]:         | Set up the audio I/F format of AK4353                                                                           |
| 14-1. [MSB] :        | MSB justified for DIT mode in AK4353.                                                                           |
| 14-2. [LSB] :        | LSB justified for DIT mode in AK4353.                                                                           |
| 14-3. [I2S] :        | I <sup>2</sup> S compatible for DIT mode in AK4353.                                                             |

Note 1. Evaluation mode of AK4353 and AK4563A is same mode.

Note 2. The default of AK4353 is MCLK=256fs and I<sup>2</sup>S compatible mode.

Note 3. MCLK of AK4353 is fixed to 256fs.

### ■ Indication of data

Input data is indicated on the register map. Red letter indicates “H” or “1” and blue one indicates “L” or “0”. Blank is the part that is not defined in the datasheet.

## ■ Explanation of each dialog

### 1. [Function1 Dialog] : Dialog to write data by keyboard operation

Address Box: Input register address in 2 figures of hexadecimal.  
 Data Box: Input register data in 2 figures of hexadecimal.

If you want to write the input data to AK4563A, click "OK" button. If not, click "Cancel" button.

### 2. [Function2 Dialog] : Dialog to evaluate IPGA and ATTL/ATTR

This dialog corresponds to only addr=0BH and 0CH, 0DH.

Address Box: Input register address in 2 figures of hexadecimal.  
 Start Data Box: Input start data in 2 figures of hexadecimal.  
 End Data Box: Input end data in 2 figures of hexadecimal.  
 Interval Box: Data is written to AK4563A by this interval.  
 Step Box: Data changes by this step.  
 Mode Select Box:

If you check this check box, data reaches end data, and returns to start data.

[Example] Start Data = 00, End Data = 09

Data flow: 00 01 02 03 04 05 06 07 08 09 09 08 07 06 05 04 03 02 01 00

If you do not check this check box, data reaches end data, but does not return to start data.

[Example] Start Data = 00, End Data = 09

Data flow: 00 01 02 03 04 05 06 07 08 09

If you want to write the input data to AK4563A, click "OK" button. If not, click "Cancel" button.

### 3. [Write Dialog] : Dialog to write data by mouse operation

There are dialogs corresponding to each register.

Click the "Write" button corresponding to each register to set up the dialog. If you check the check box, data becomes "H" or "I". If not, "L" or "O".

If you want to write the input data to AK4563A, click "OK" button. If not, click "Cancel" button.

### 4.[Save] and [Open]

#### 4-1. [Save]

Save the current register setting data. The extension of file name is "akr".

(Operation flow)

- (1) Click [Save] Button.
- (2) Set the file name and push [Save] Button. The extension of file name is "akr".

#### 4 -2. [Open]

The register setting data saved by [Save] is written to AK4563A. The file type is the same as [Save].

(Operation flow)

- (1) Click [Open] Button.
- (2) Select the file (\*.akr) and Click [Open] Button.

**5.[Function3 Dialog]**

The sequence of register setting can be set and executed.

- (1) Click [F3] Button.
- (2) Set the control sequence.  
Set the address, Data and Interval time. Set "-1" to the address of the step where the sequence should be paused.
- (3) Click [Start] button. Then this sequence is executed.

The sequence is paused at the step of Interval="-1". Click [START] button, the sequence restarts from the paused step.

This sequence can be saved and opened by [Save] and [Open] button on the Function3 window. The extension of file name is "aks".

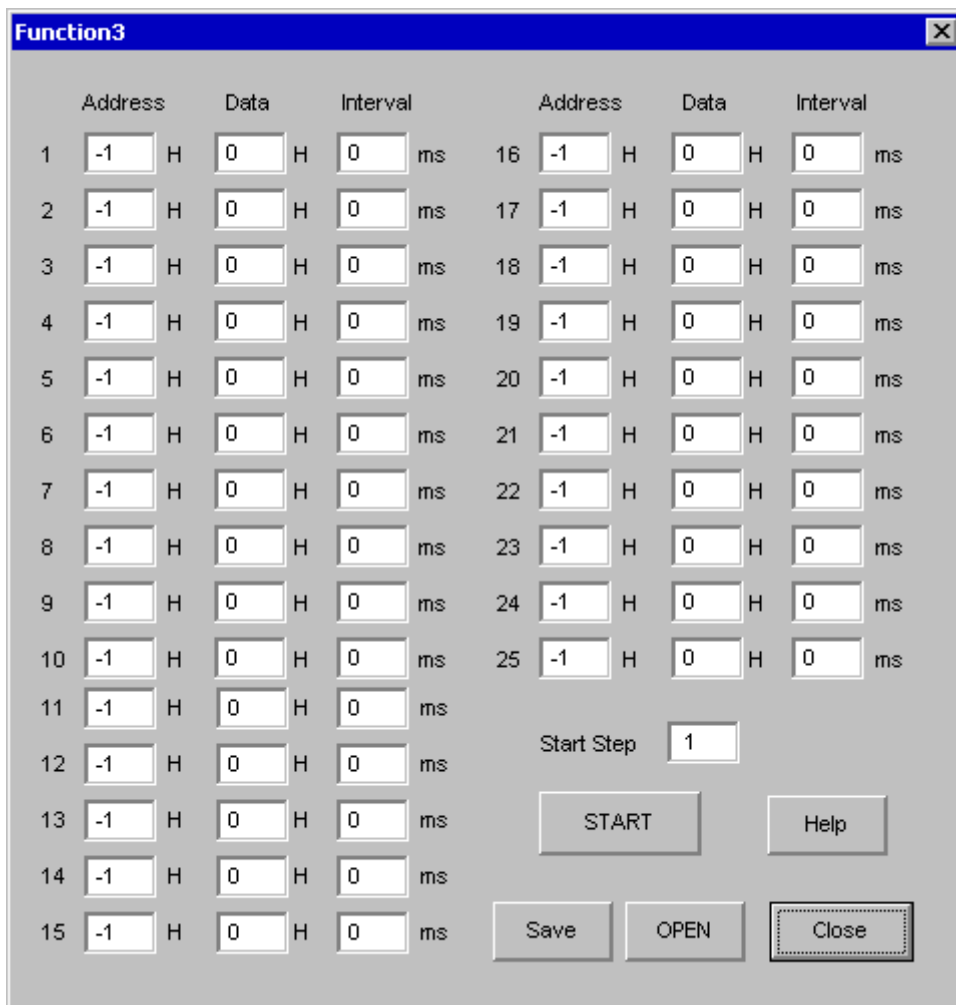

**Figure 1. Window of [F3]**

### 6. [Function4 Dialog]

The sequence that is created on [Function3] can be assigned to buttons and executed. When [F4] button is clicked, the window as shown in Figure2 opens.

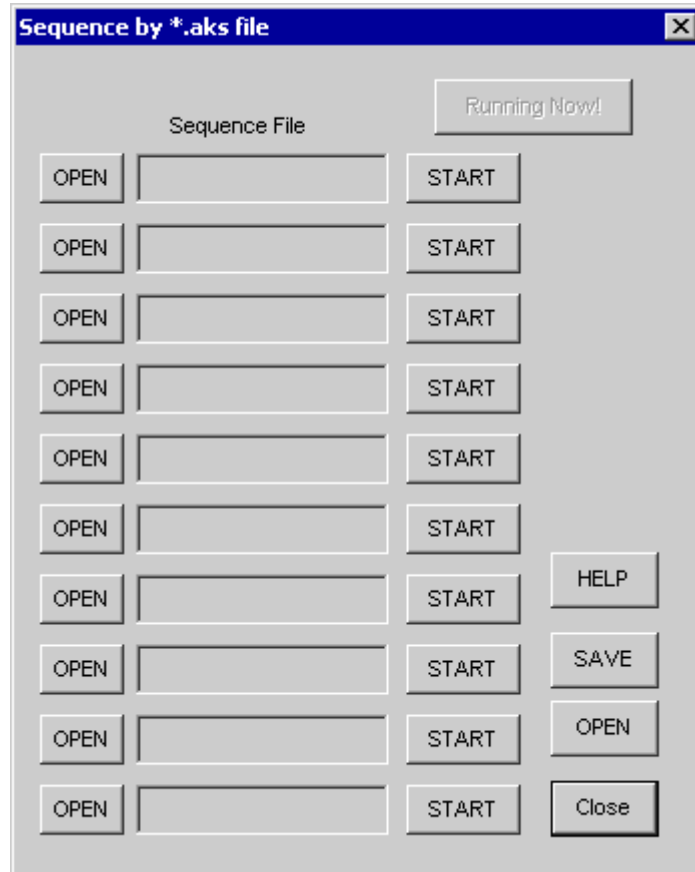

Figure 2. [F4] window

6-1. [OPEN] buttons on left side and [START] buttons

(1) Click [OPEN] button and select the sequence file (\*.aks).

The sequence file name is displayed as shown in Figure 3.

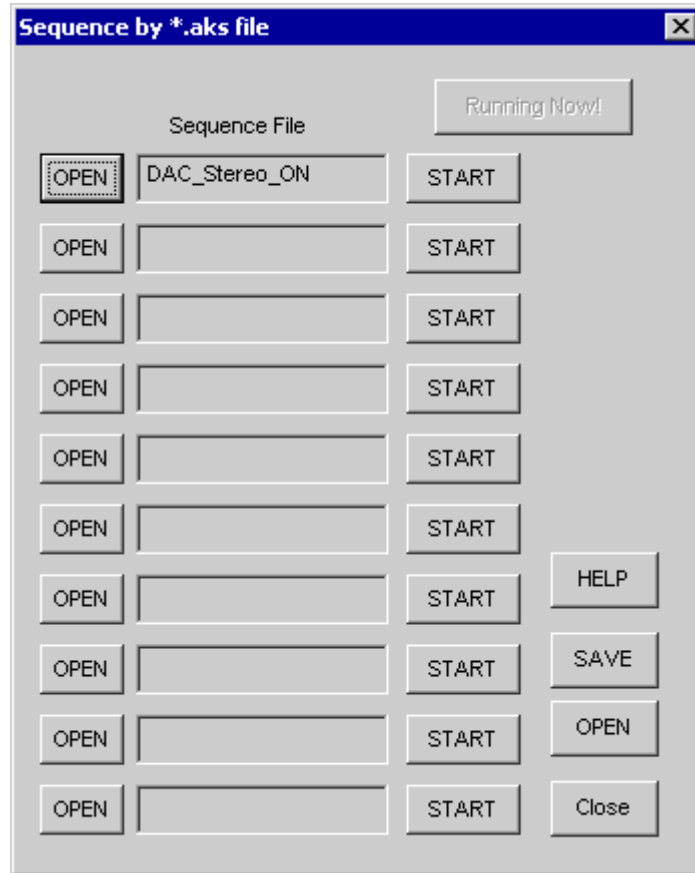

Figure 3. [F4] window(2)

(2) Click [START] button, then the sequence is executed.

6-2. [SAVE] and [OPEN] buttons on right side

[SAVE] : The sequence file names can assign be saved. The file name is \*.ak4.

[OPEN] : The sequence file names assign that are saved in \*.ak4 are loaded.

6-3. Note

- (1) This function doesn't support the pause function of sequence function.
- (2) All files need to be in same folder used by [SAVE] and [OPEN] function on right side.
- (3) When the sequence is changed in [Function3], the file should be loaded again in order to reflect the change.

## 7.[Function5 Dialog]

The register setting that is created by [SAVE] function on main window can be assigned to buttons and executed. When [F5] button is clicked, the following window as shown in Figure 4 opens.

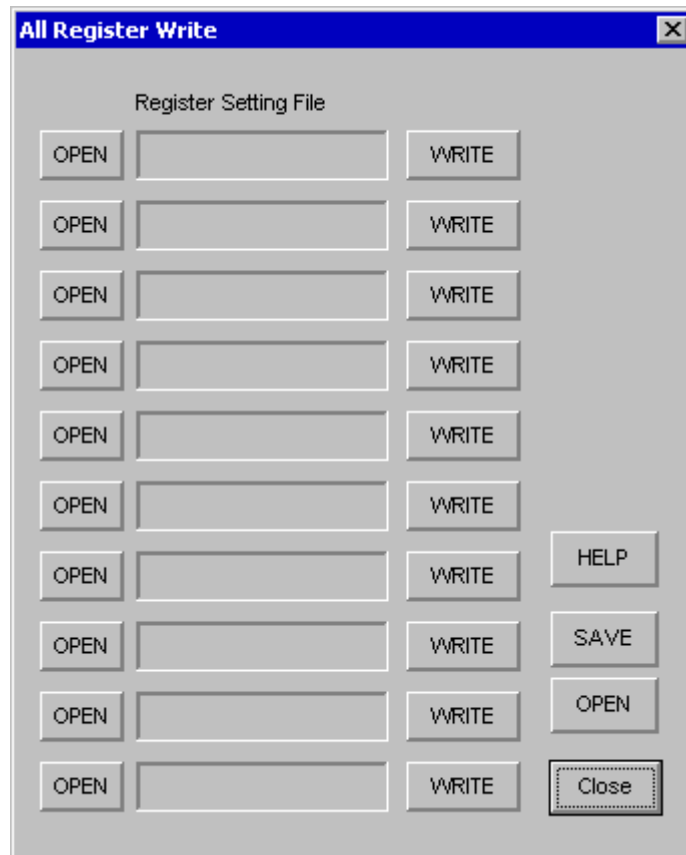

Figure 4. [F5] window

### 7-1. [OPEN] buttons on left side and [WRITE] button

- (1) Click [OPEN] button and select the register setting file (\*.akr).  
The register setting file name is displayed as shown in Figure 5.
- (2) Click [WRITE] button, then the register setting is executed.

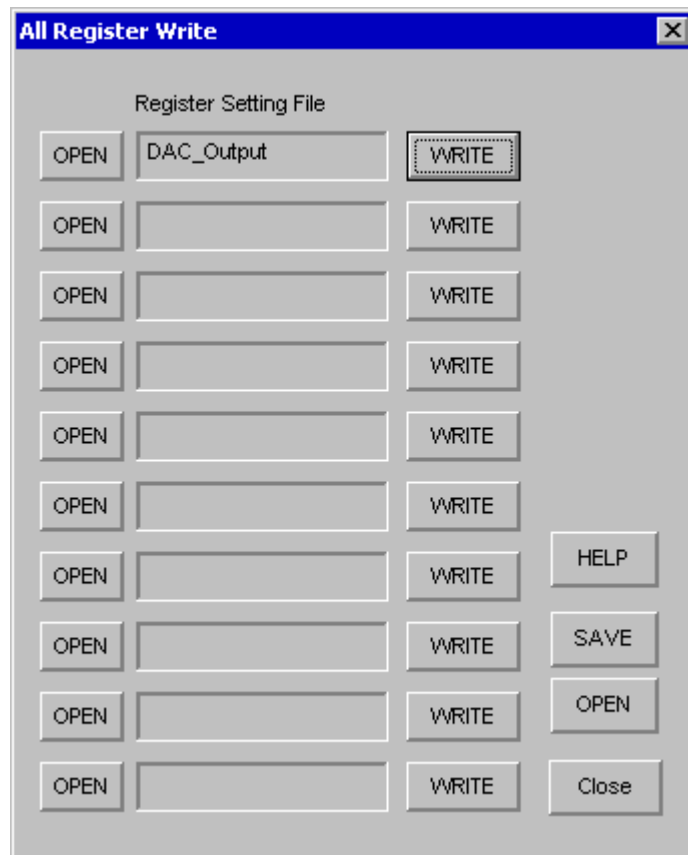

Figure 5. [F5] windows(2)

7-2. [SAVE] and [OPEN] buttons on right side

[SAVE] : The register setting file names assign can be saved. The file name is \*.ak5.

[OPEN] : The register setting file names assign that are saved in \*.ak5 are loaded.

7-3. Note

- (1) All files need to be in same folder used by [SAVE] and [OPEN] function on right side.
- (2) When the register setting is changed by [Save] Button in main window, the file should be loaded again in order to reflect the change.

## 2. [Function2 Dialog] : Dialog to evaluate IPGA

This dialog corresponds to only addr=07H.

Address Box: Input register address in 2 figures of hexadecimal.

Start Data Box: Input start data in 2 figures of hexadecimal.

End Data Box: Input end data in 2 figures of hexadecimal.

Interval Box: Data is written to AK4563A by this interval.

Step Box: Data changes by this step.

Mode Select Box:

If you check this check box, data reaches end data, and returns to start data.

[Example] Start Data = 00, End Data = 09

Data flow: 00 01 02 03 04 05 06 07 08 09 09 08 07 06 05 04 03 02 01 00

If you do not check this check box, data reaches end data, but does not return to start data.

[Example] Start Data = 00, End Data = 09

Data flow: 00 01 02 03 04 05 06 07 08 09

If you want to write the input data to AK4563A, click "OK" button. If not, click "Cancel" button.

## 3. [Write Dialog] : Dialog to write data by mouse operation

There are dialogs corresponding to each register.

Click the "Write" button corresponding to each register to set up the dialog. If you check the check box, data becomes "H" or "1". If not, "L" or "0".

If you want to write the input data to AK4563A, click "OK" button. If not, click "Cancel" button.

### ■ Operation flow

Keep the following flow surely.

4. Set up the control program according to explanation above.
5. Click "Port Setup" button.
6. Click "Write default" button.
7. Set up evaluation mode of AK4353.
8. Then set up the dialog and input data.

### ■ Indication of data

Input data is indicated on the register map. Red letter indicates "H" or "1" and blue one indicates "L" or "0". Blank is the part that is not defined in the datasheet.

### ■ Attention on the operation

If you set up Function1 or Function2 dialog, input data to all boxes. Attention dialog is indicated if you input data or address that is not specified in the datasheet or you click "OK" button before you input data. In that case set up the dialog and input data once more again. These operations does not need if you click "Cancel" button or check the check box.



<b>MEASUREMENT RESULTS</b>
----------------------------

## [Measurement condition]

- Measurement unit : Audio Precision, System Two
- MCLK : 256fs
- BCLK : 64fs
- fs : 48kHz
- Bit : 16bit
- Power Supply : VA=VD=VT=2.5V
- Interface : DIR/DIT
- Temperature : Room

## [Measurement Results]

Parameter	Input Pin	Result (Lch / Rch)	Unit
<b>ADC Analog Input Characteristics</b>			
S/(N+D) (-2.0dB Input)	INTL0 / INTR0	86.0 / 86.0	dB
	INTL1 / INTR1	86.0 / 86.0	dB
	EXTL / EXTR	86.0 / 86.0	dB
	LIN / RIN	85.6 / 85.6	dB
D-Range (A-weighted)	INTL0 / INTR0	88.6 / 88.6	dB
	INTL1 / INTR1	88.6 / 88.6	dB
	EXTL / EXTR	88.6 / 88.6	dB
	LIN / RIN	88.1 / 88.1	dB
S/N (A-weighted)	INTL0 / INTR0	88.6 / 88.6	dB
	INTL1 / INTR1	88.6 / 88.6	dB
	EXTL / EXTR	88.6 / 88.6	dB
	LIN / RIN	88.1 / 88.1	dB
Interchannel Isolation	INTL0 / INTR0	106.8 / 108.4	dB
	INTL1 / INTR1	108.1 / 108.2	dB
	EXTL / EXTR	109.4 / 106.5	dB
	LIN / RIN	107.4 / 107.5	dB
<b>DAC Analog Output Characteristics</b>			
S/(N+D)	-	88.0 / 89.0	dB
D-Range (A-weighted)	-	92.3 / 92.3	dB
S/N (A-weighted)	-	92.9 / 92.9	dB
Interchannel Isolation	-	107.8 / 107.0	dB

[ADC Plot]

AKM

AK4563A ADC THD+N vs. Input Level  
VA=VD=VT=2.5V, fs=48kHz, fin=1kHz

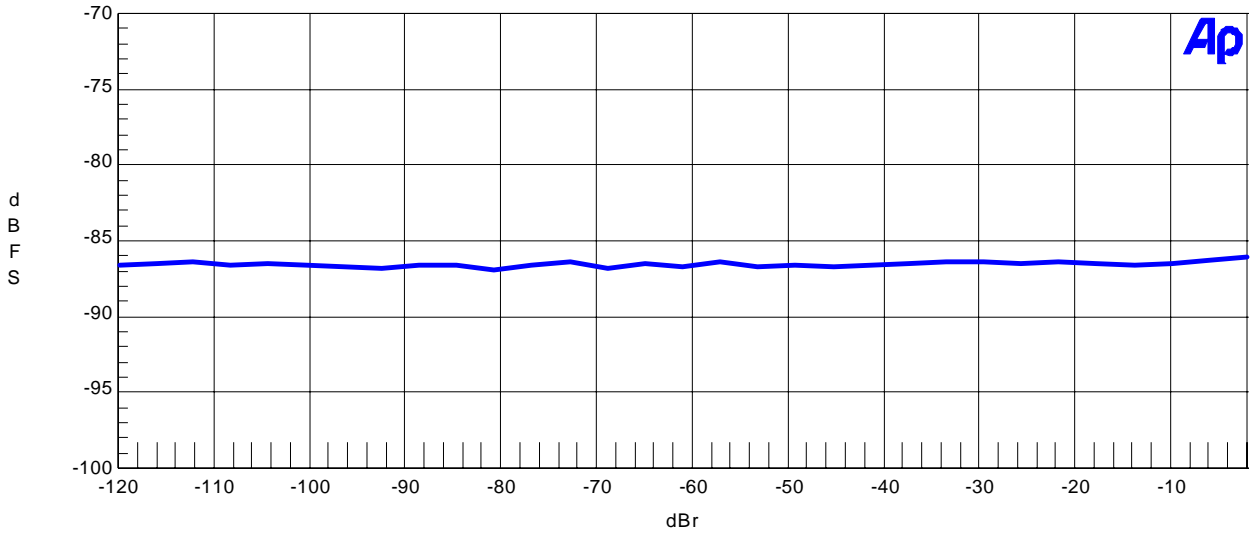

Figure 1. THD+N vs. Input Level

AKM

AK4563A ADC THD+N vs. Input Frequency  
VA=VD=VT=2.5V, fs=48kHz, Input=-2.0dB

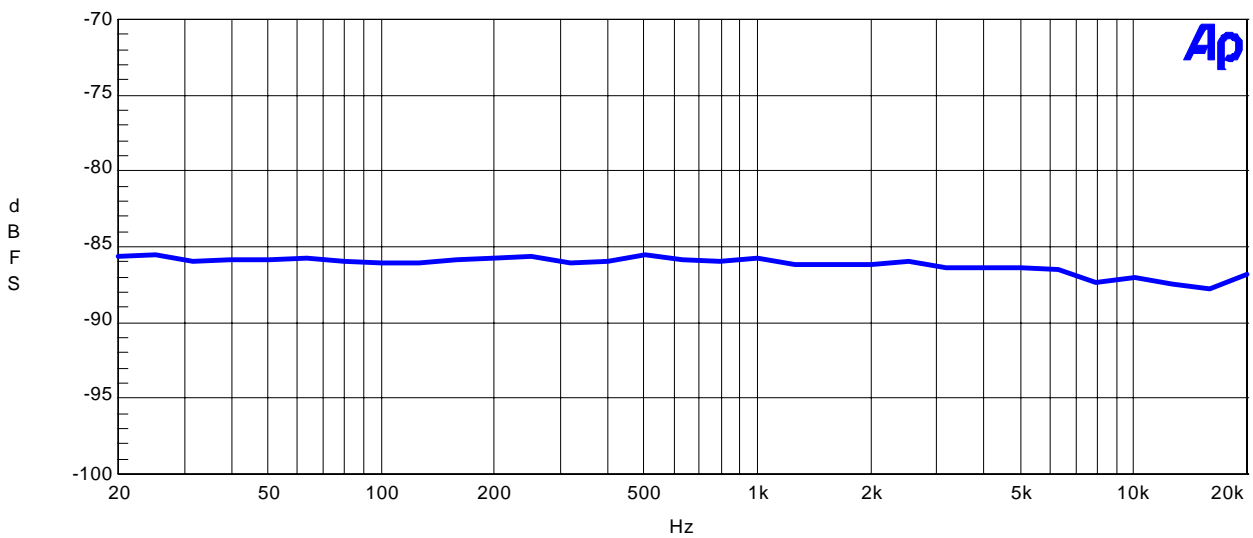

Figure 2. THD+N vs. Input Frequency

AKM

AK4563A ADC Linearity  
VA=VD=VT=2.5V, fs=48kHz, fin=1kHz

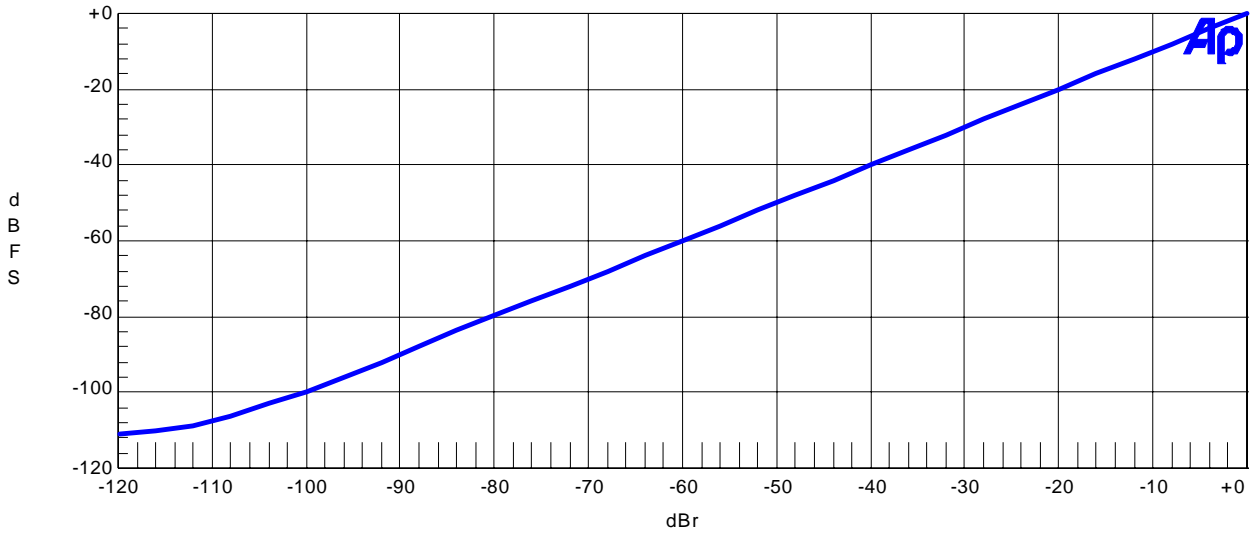

Figure 3. Linearity

AKM

AK4563A ADC Frequency Response  
VA=VD=VT=2.5V, fs=48kHz, Input=-2.0dBr

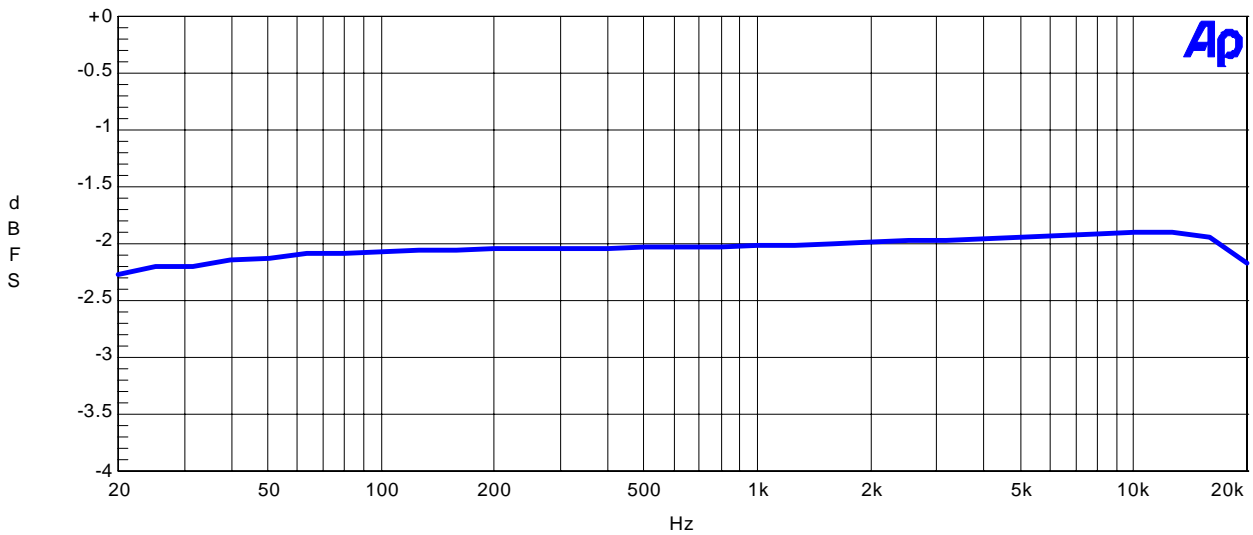

Figure 4. Frequency Response

AKM

AK4563A ADC Crosstalk  
VA=VD=VT=2.5V, fs=48kHz, Input=-2.0dB

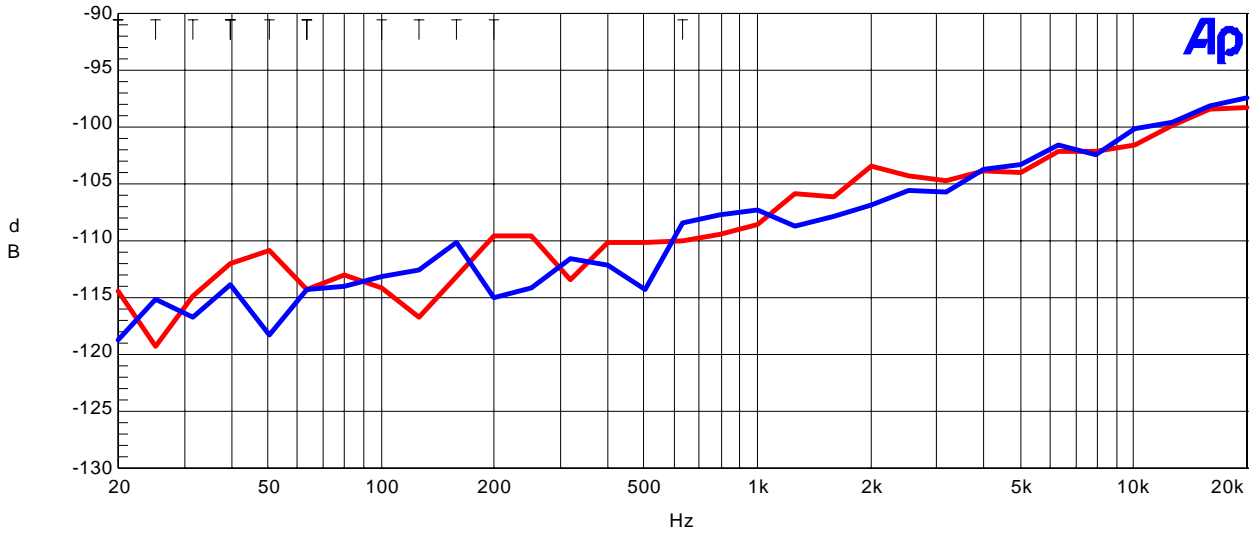

Figure 5. Crosstalk

AKM

AK4563A ADC FFT Plot  
VA=VD=VT=2.5V, fs=48kHz, Input=-2.0dB, fin=1 kHz

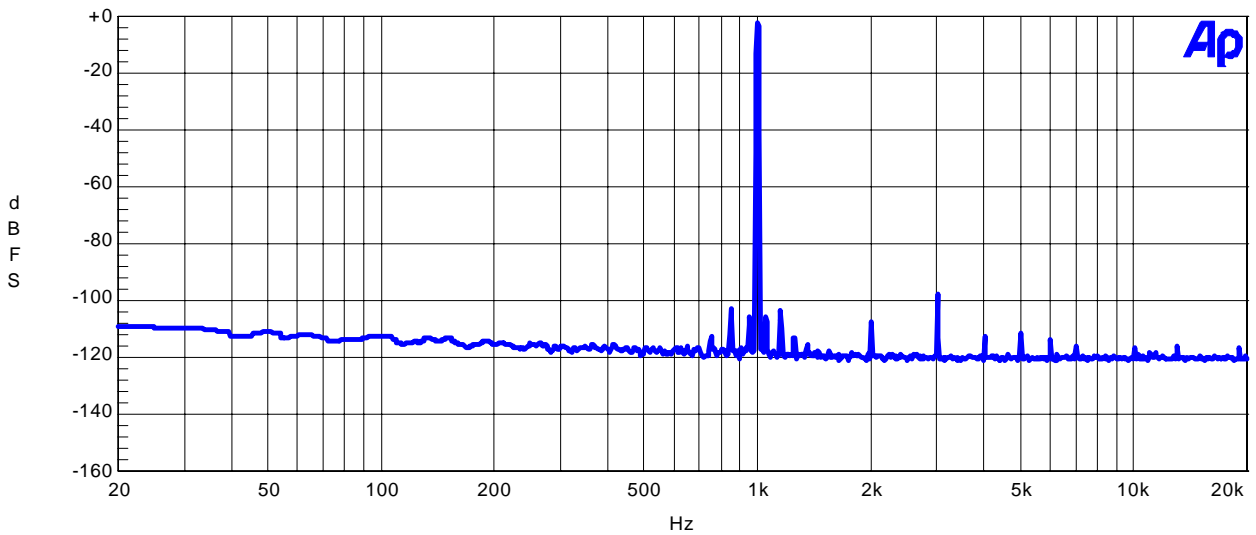

Figure 6. FFT Plot

AKM

AK4563A ADC FFT Plot  
VA=VD=VT=2.5V, fs=48kHz, Input=-60dBr, fin=1kHz

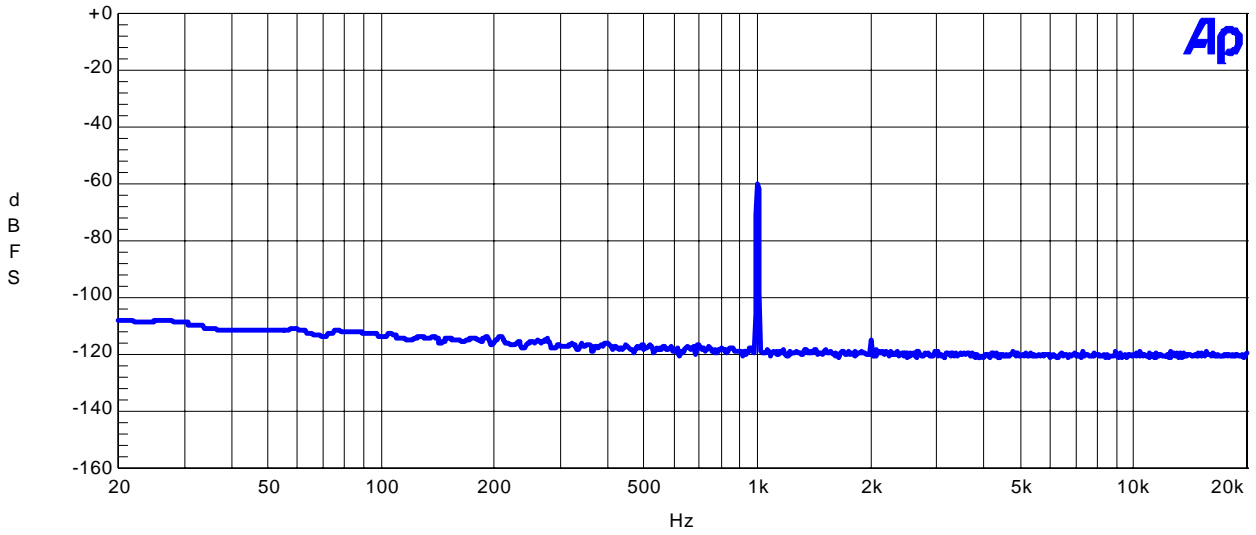

Figure 7. FFT Plot

AKM

AK4563A ADC FFT Plot  
VA=VD=VT=2.5V, fs=48kHz, fin=None

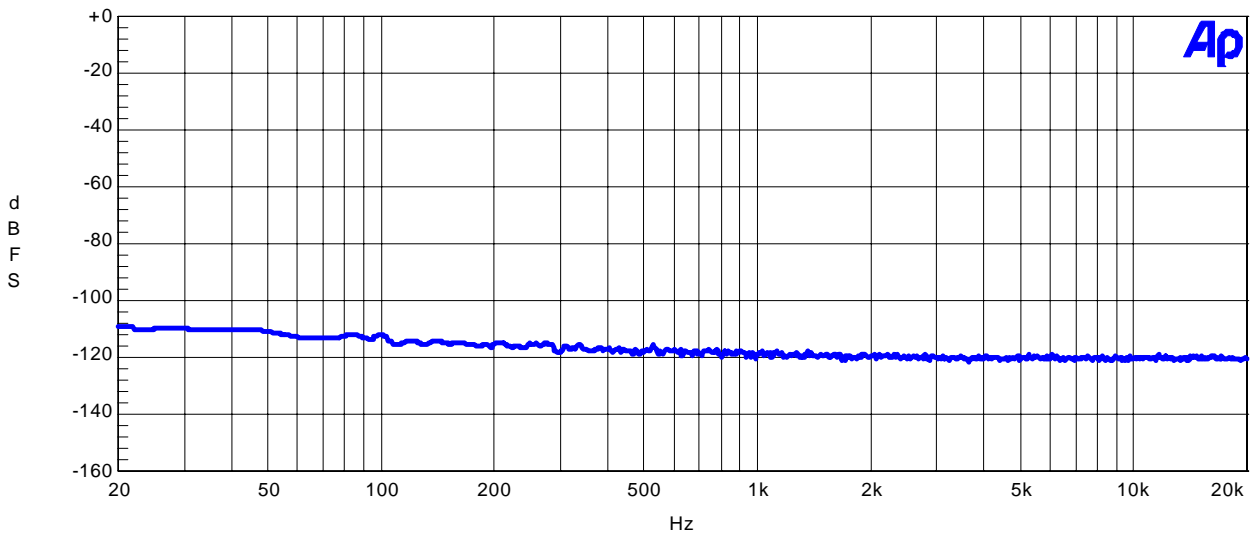

Figure 8. FFT Plot

[DAC Plot]

AKM

AK4563A DAC THD+N vs. Input Level  
VA=VD=VT=2.5V, fs=48kHz, fin=1kHz

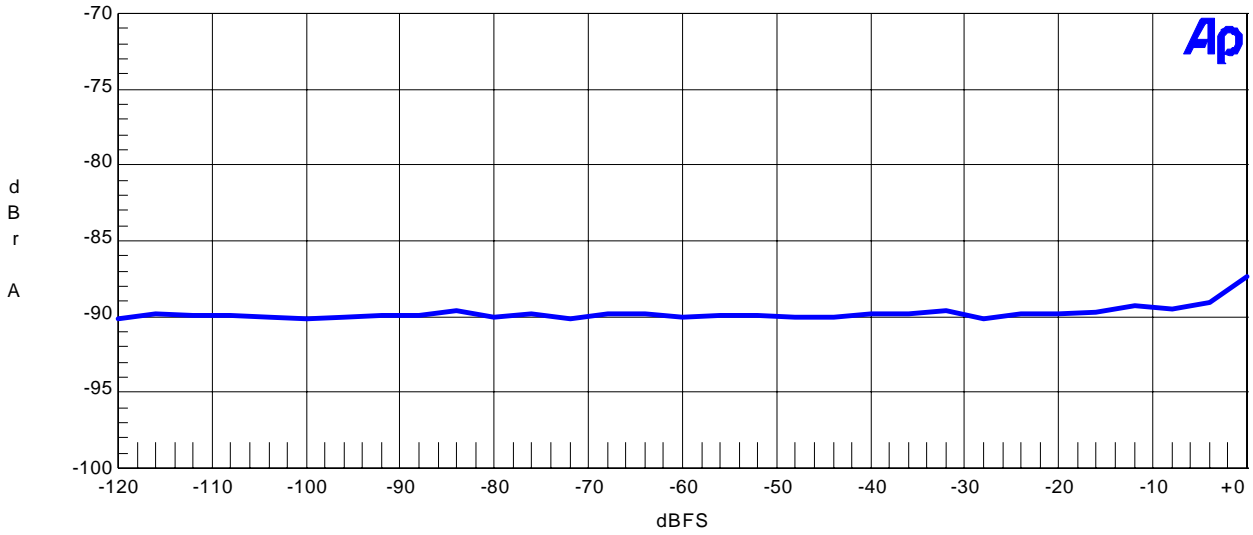

Figure 1. THD+N vs. Input Level

AKM

AK4563A DAC THD+N vs. Input Frequency  
VA=VD=VT=2.5V, fs=48kHz, Input=0dBFS

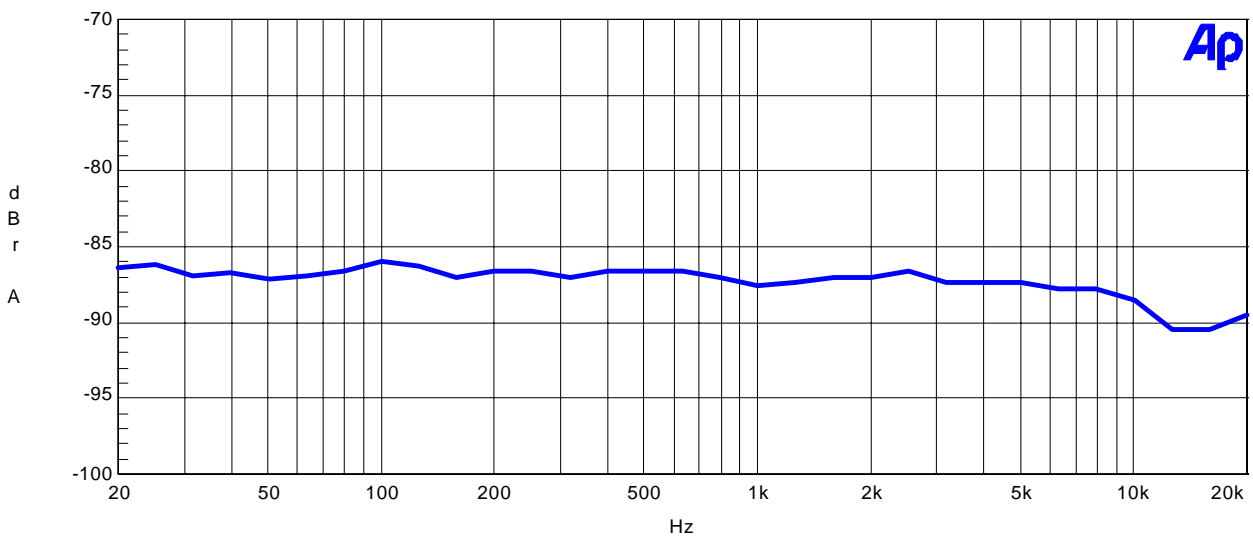

Figure 2. THD+N vs. Input Frequency

AKM

AK4563A DAC Linearity  
VA=VD=VT=2.5V, fs=48kHz, fin=1kHz

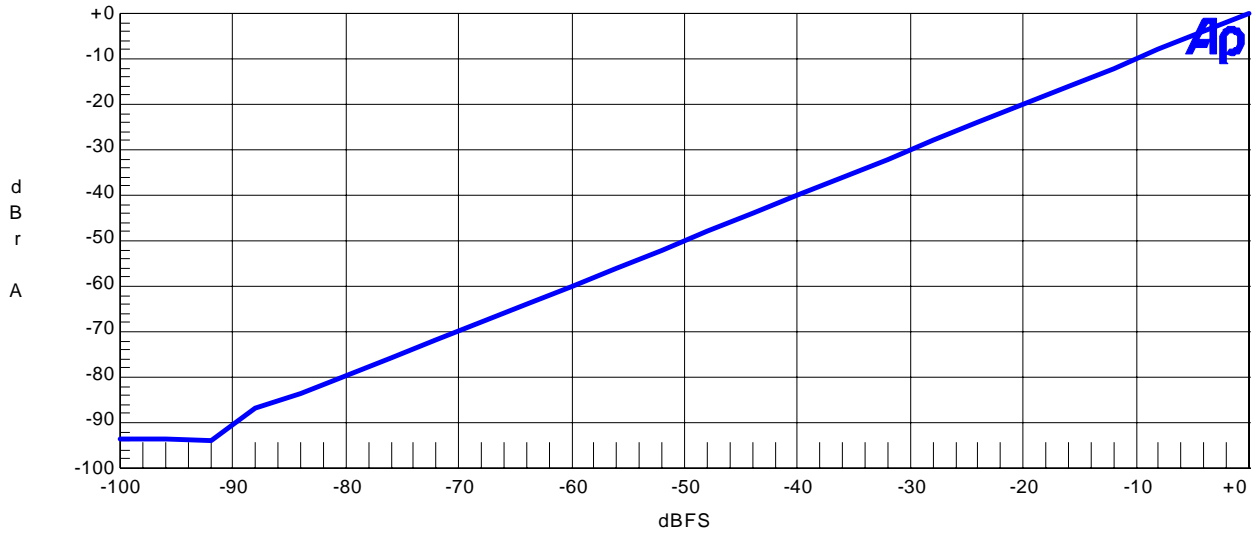

Figure 3. Linearity

AKM

AK4563A DAC Frequency Response  
VA=VD=VT=2.5V, fs=48kHz, Input=0dBFS

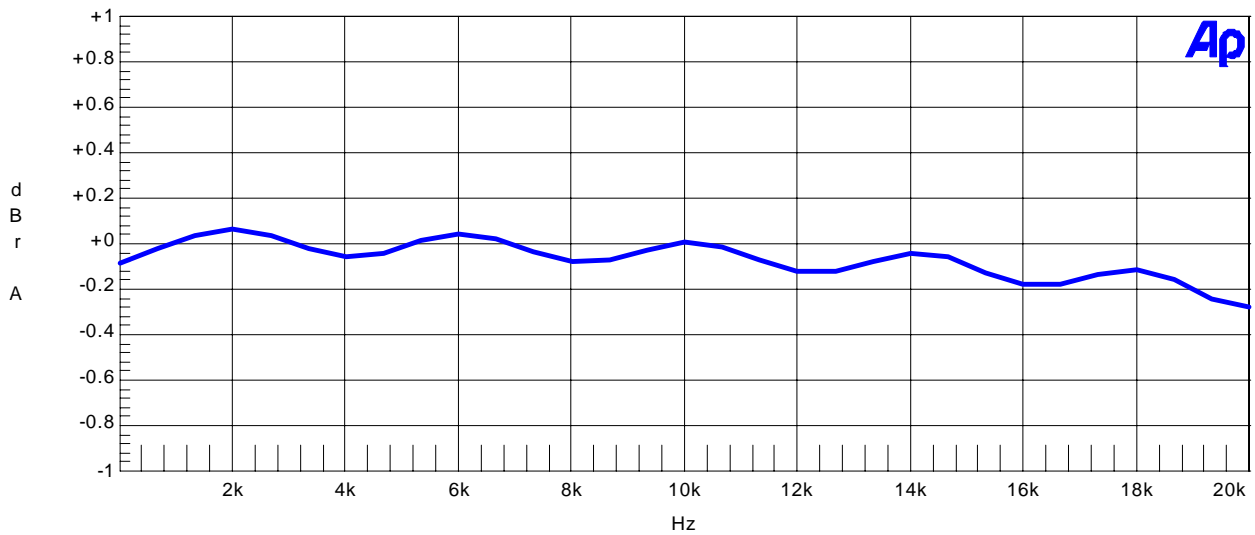

Figure 4. Frequency Response

AKM

AK4563A DAC Crosstalk  
VA=VD=VT=2.5V, fs=48kHz, Input=0dBFS

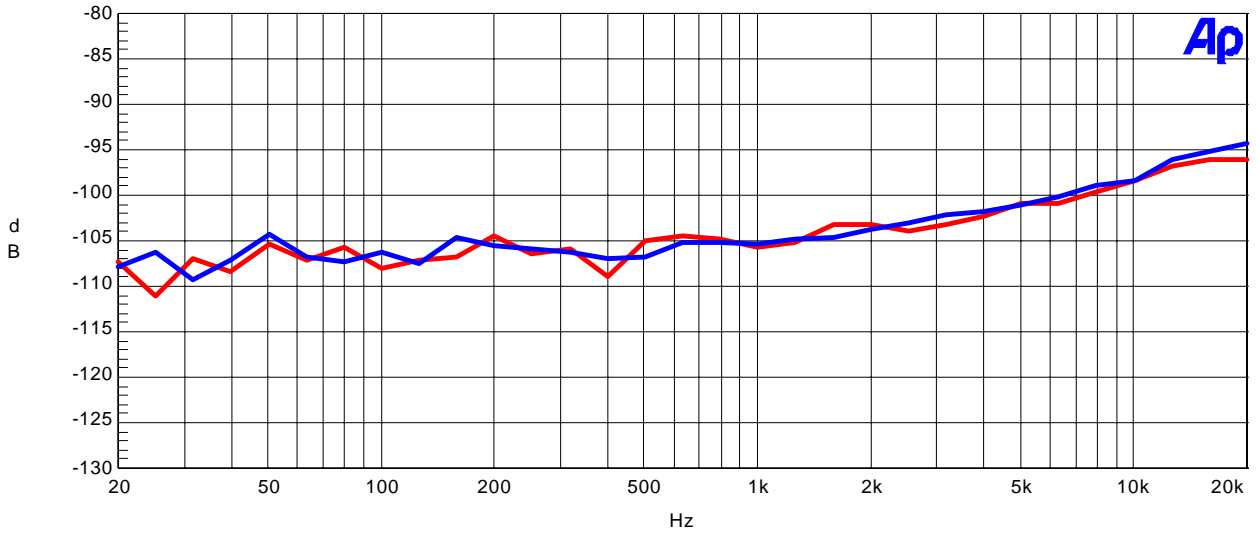

Figure 5. Crosstalk

AKM

AK4563A DAC FFT Plot  
VA=VD=VT=2.5V, fs=48kHz, Input=0dBFS, fin=1 kHz

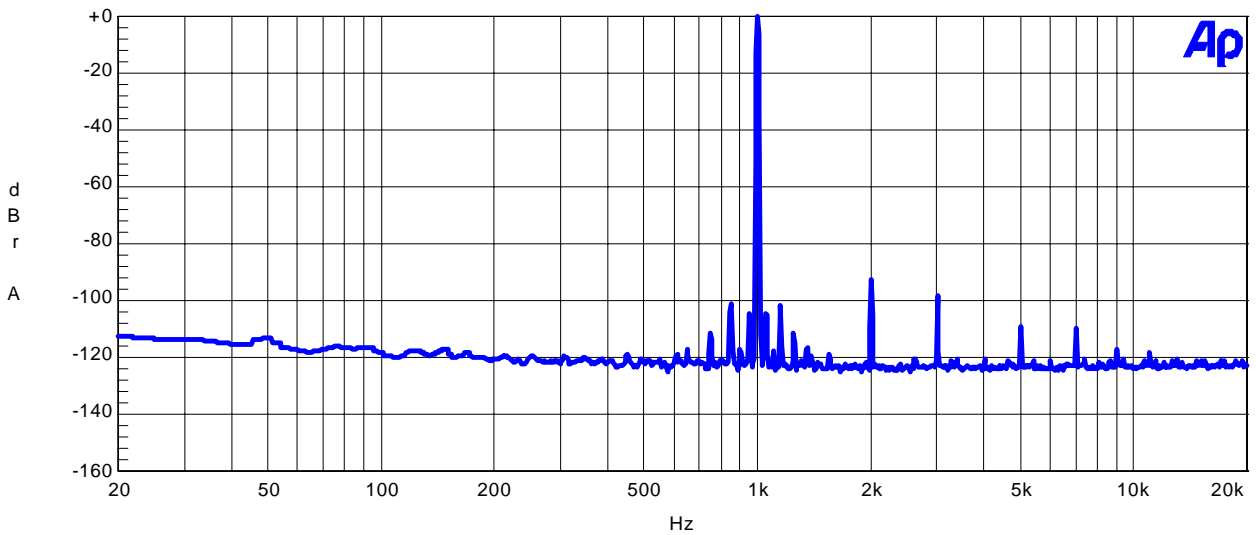

Figure 6. FFT Plot



AKM

AK4563A DAC FFT Plot  
VA=VD=VT=2.5V, fs=48kHz, Input=-60dBFS, fin=1kHz

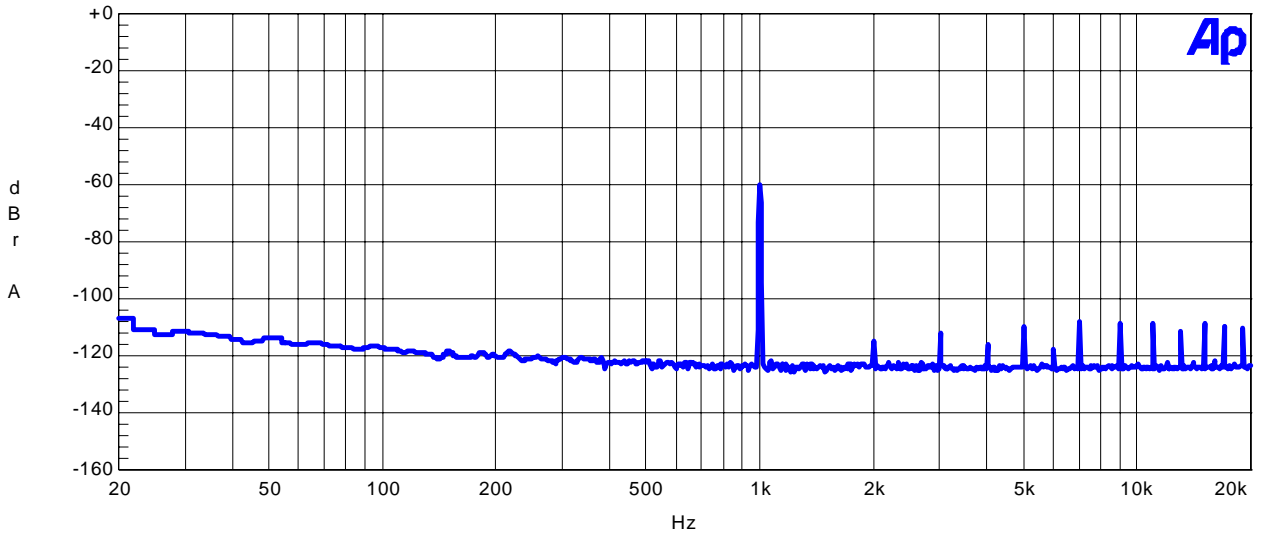

Figure 7. FFT Plot

AKM

AK4563A DAC FFT Plot  
VA=VD=VT=2.5V, fs=48kHz, fin=None

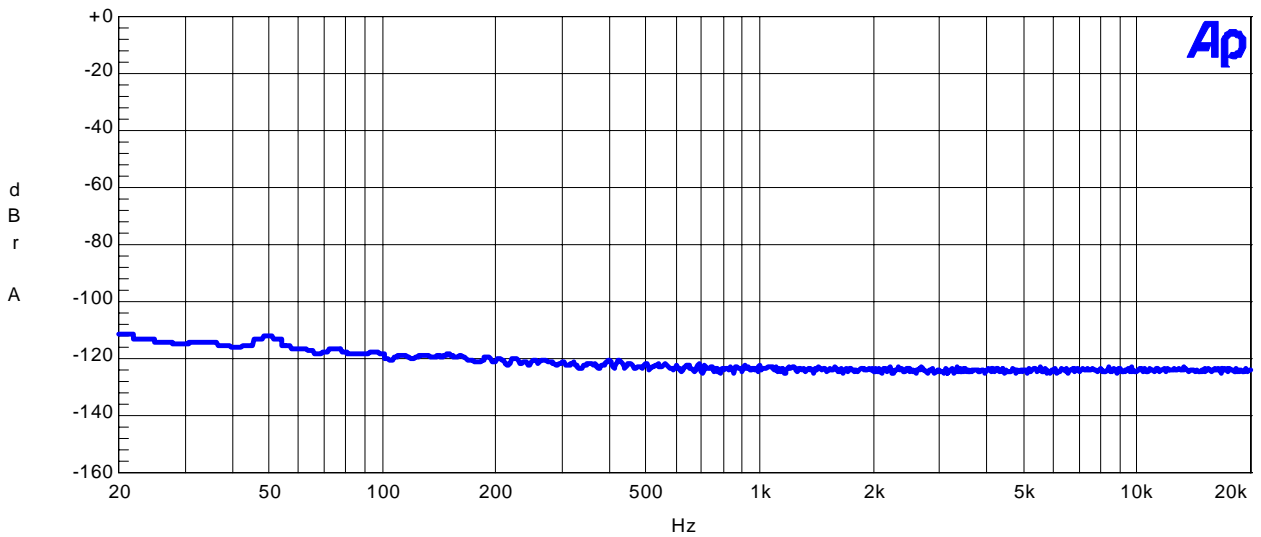

Figure 8. FFT Plot

<b>Revision History</b>			
-------------------------	--	--	--

Date (YY/MM)	Manual Revision	Reason	Contents
2000 / 12	KM064400	First Edition	
2006 / 06	KM064401	Update	Change of a figure & circuit

**IMPORTANT NOTICE**

- These products and their specifications are subject to change without notice. Before considering any use or application, consult the Asahi Kasei Microsystems Co., Ltd. (AKM) sales office or authorized distributor concerning their current status.
- AKM assumes no liability for infringement of any patent, intellectual property, or other right in the application or use of any information contained herein.
- Any export of these products, or devices or systems containing them, may require an export license or other official approval under the law and regulations of the country of export pertaining to customs and tariffs, currency exchange, or strategic materials.
- AKM products are neither intended nor authorized for use as critical components in any safety, life support, or other hazard related device or system, and AKM assumes no responsibility relating to any such use, except with the express written consent of the Representative Director of AKM. As used here:
  - (a) A hazard related device or system is one designed or intended for life support or maintenance of safety or for applications in medicine, aerospace, nuclear energy, or other fields, in which its failure to function or perform may reasonably be expected to result in loss of life or in significant injury or damage to person or property.
  - (b) A critical component is one whose failure to function or perform may reasonably be expected to result, whether directly or indirectly, in the loss of the safety or effectiveness of the device or system containing it, and which must therefore meet very high standards of performance and reliability.
- It is the responsibility of the buyer or distributor of an AKM product who distributes, disposes of, or otherwise places the product with a third party to notify that party in advance of the above content and conditions, and the buyer or distributor agrees to assume any and all responsibility and liability for and hold AKM harmless from any and all claims arising from the use of said product in the absence of such notification.

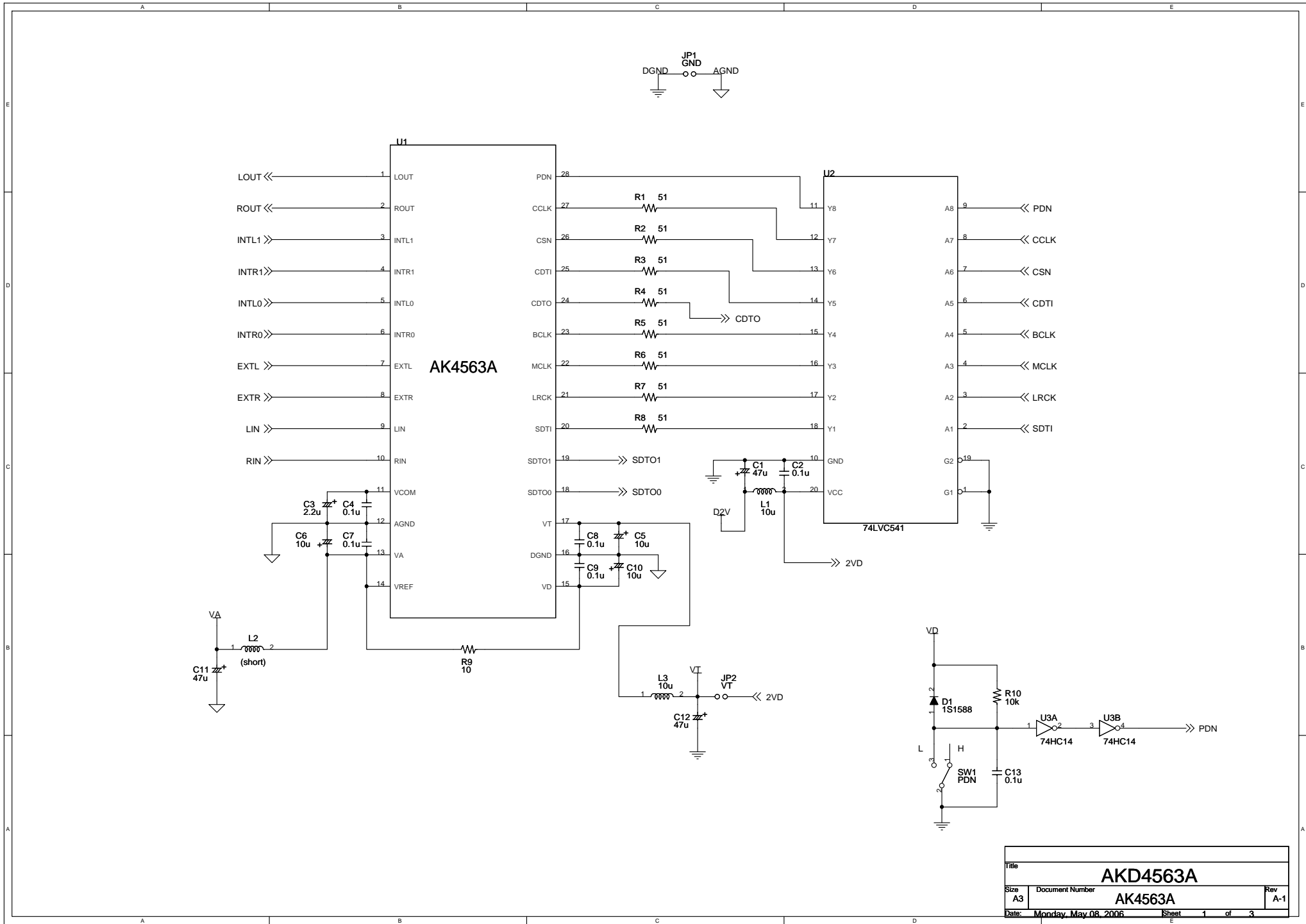

Title			<b>AKD4563A</b>		
Size	Document Number				Rev
A3	AK4563A				A-1
Date:	Monday, May 08, 2006	Sheet	1	of	3

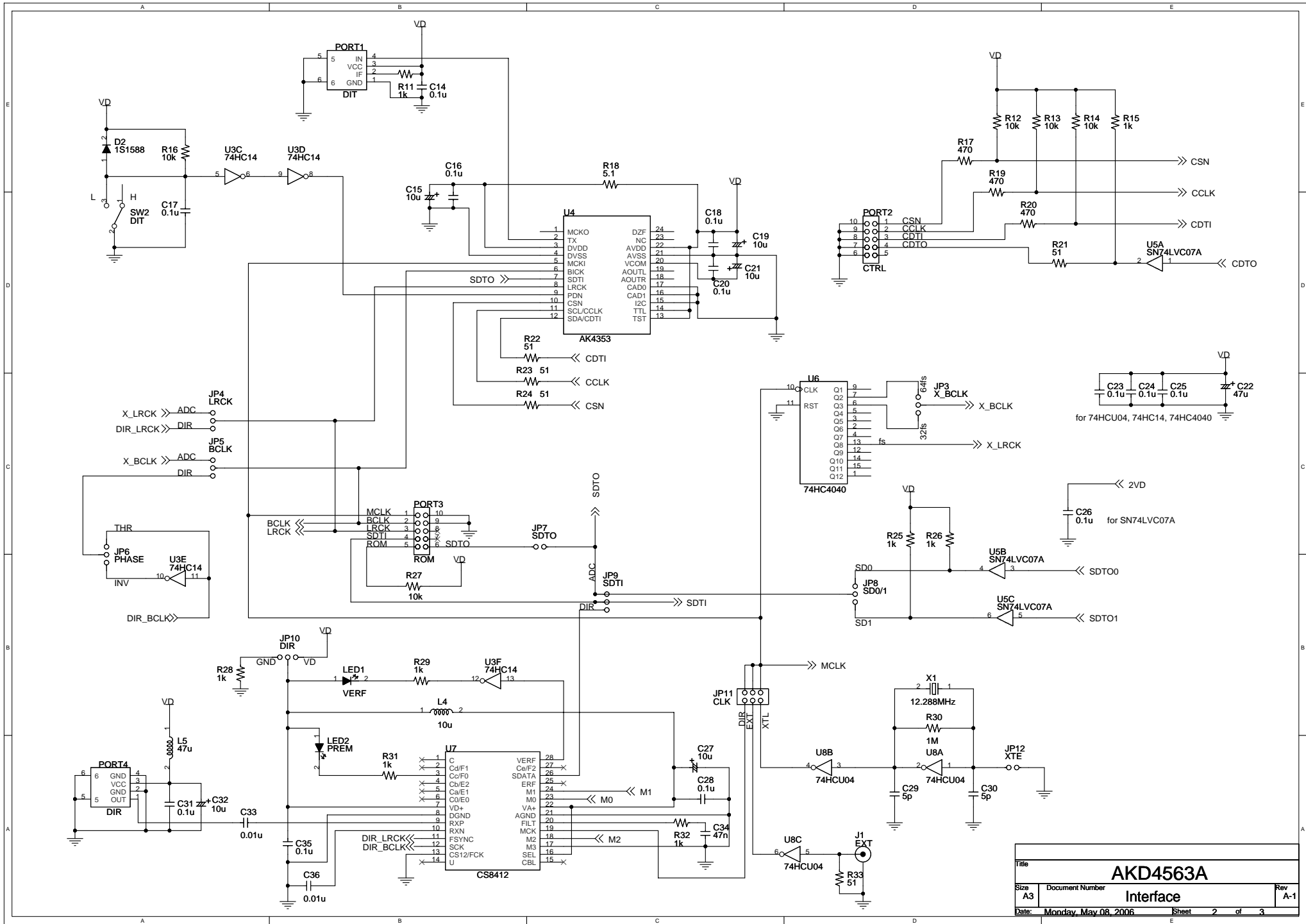

Title			<b>AKD4563A</b>	
Size	Document Number	Interface		Rev
A3				A-1
Date:	Monday, May 08, 2006	Sheet	2	of 3

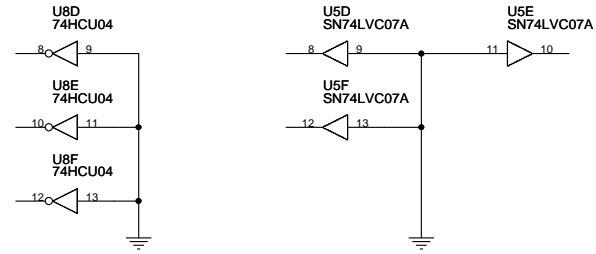
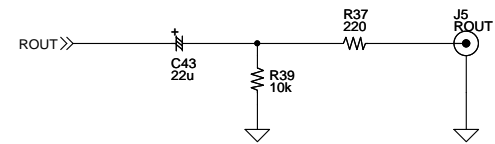
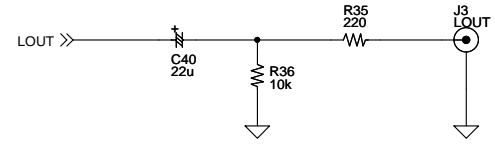
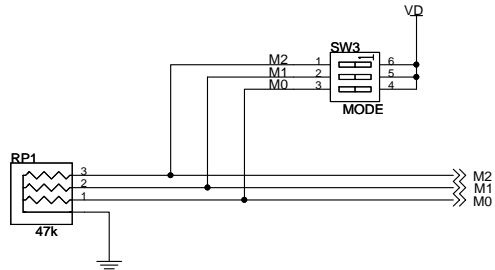
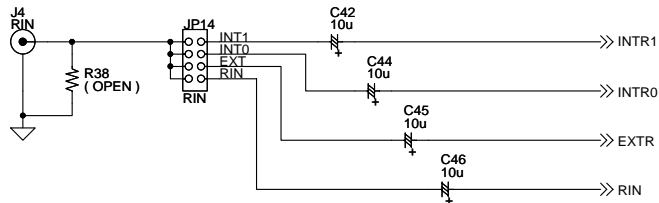
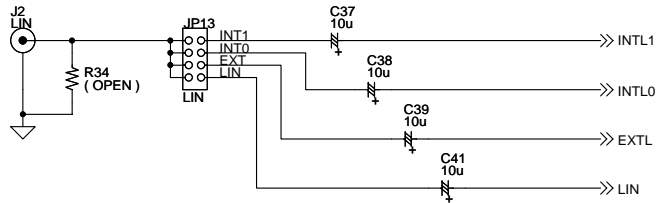

Title			
<b>AKD4563A</b>			
Size	Document Number	Rev	
A3	Input/Output	A-1	
Date: Monday, May 08, 2006		Sheet	3 of 3

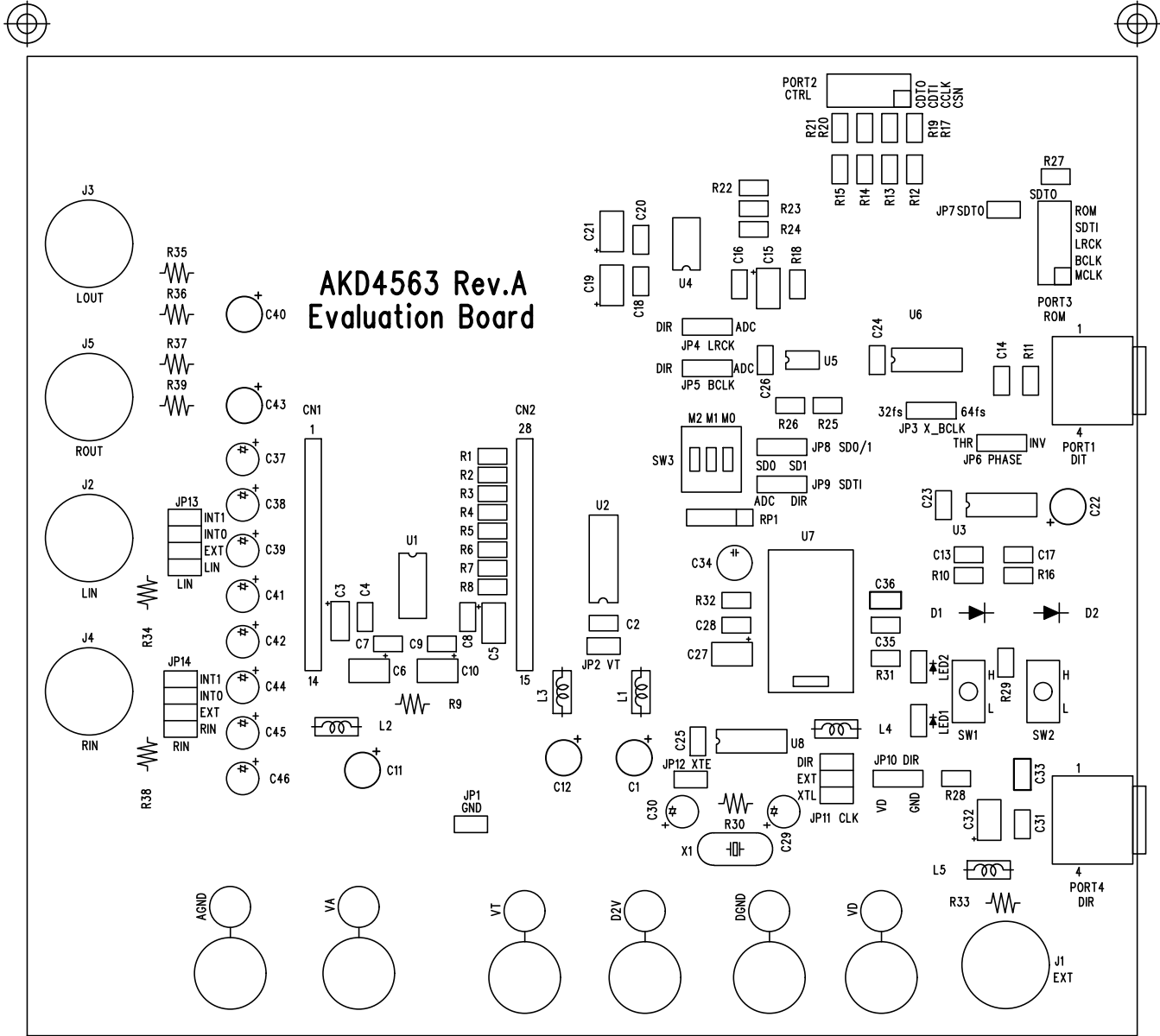

5A1495 部品面シルク

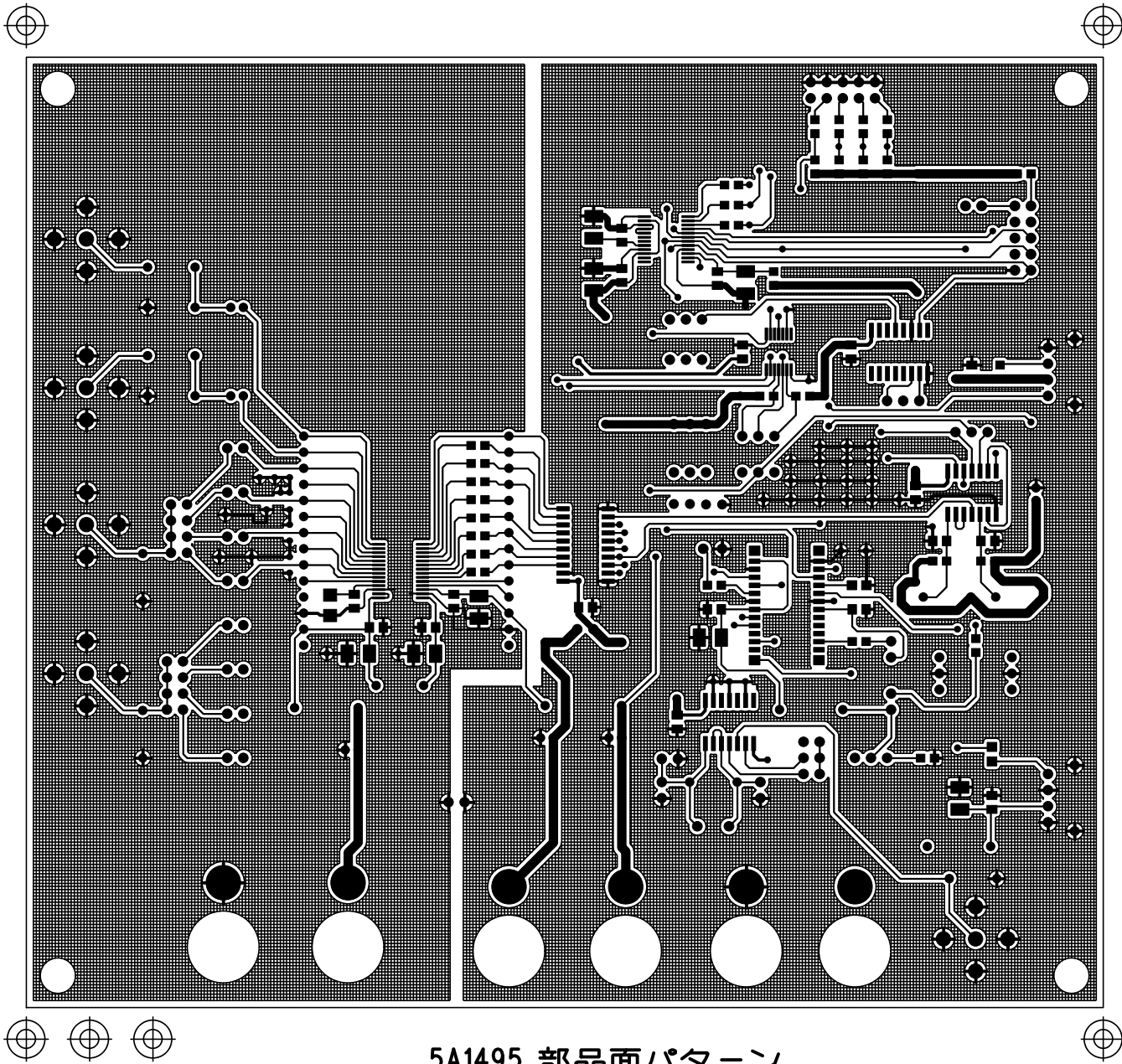

5A1495 部品面パターン

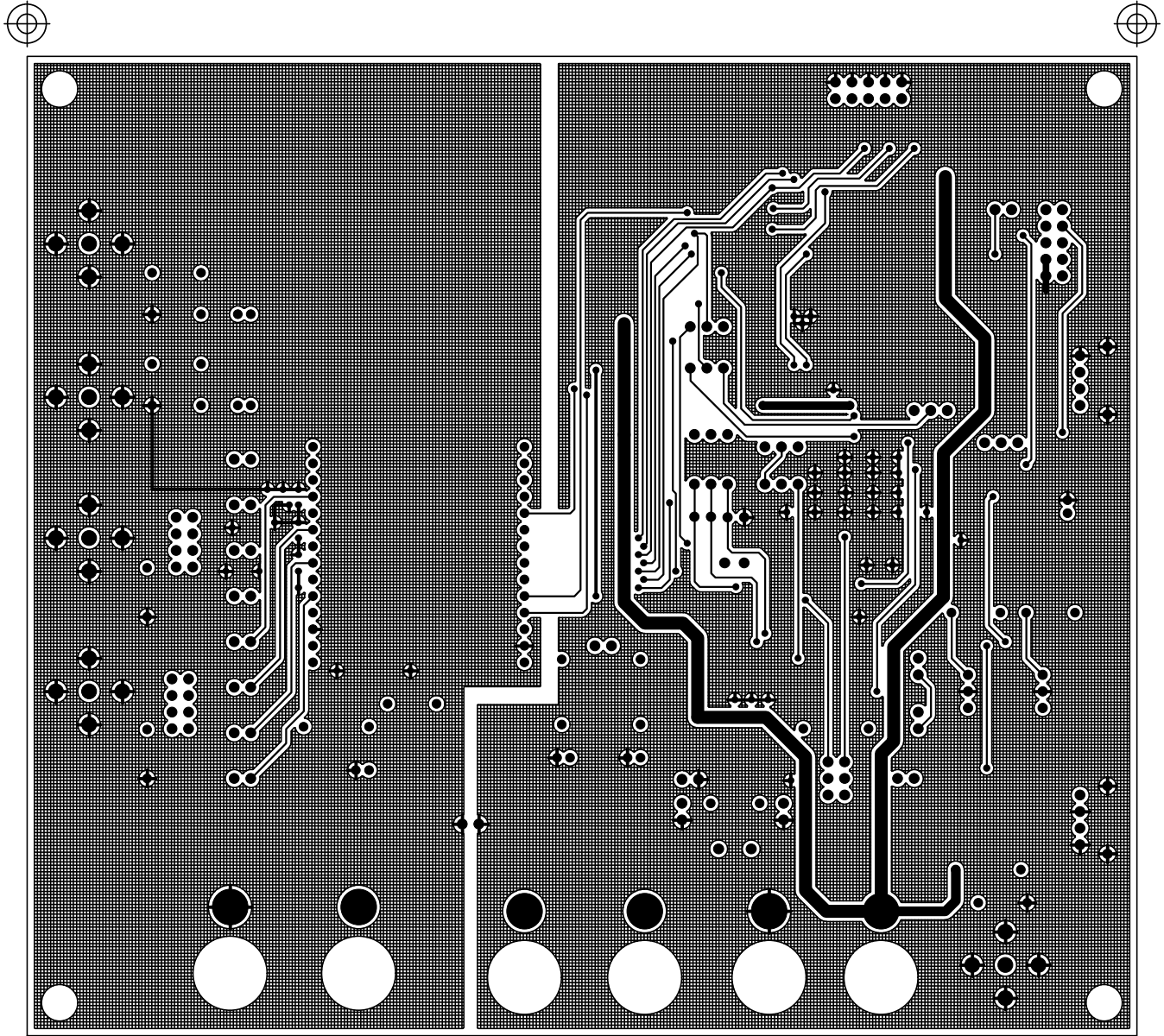

2A142 半田面八マシ