

TLP848

- Camera Module for Mobile Phone
- Digital Still Camera and Video Camera
- Personal Equipment and Small-sized OA Equipment

The TLP848 is a surface-mount photointerrupter which is composed of a GaAs infrared LED and a Si phototransistor.

It is an ultra compact package. Moreover it has a wider gap width than 1mm gap width of industry-standard and has a high resolution.

- Ultra compact package : 2.8×1.9×2.5mm (typ.)
- Surface-mount type
- Lead(Pb)-Free
- Gap width : 1.2mm (typ.)
- High resolution : Slit width 0.3 mm (typ.)
- High current transfer ratio : $I_C/I_F = 3\%$ (min)
- Material of the package : PPS (Polyphenylene sulfide)
(UL94V-0)

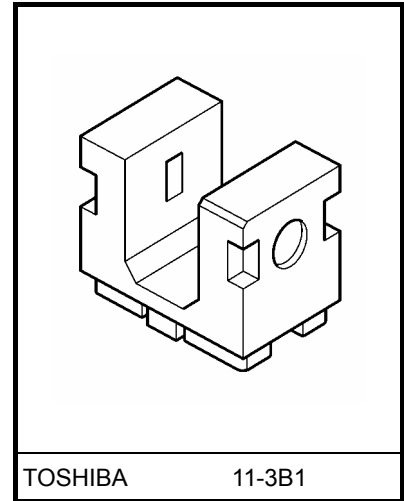

Weight: 0.017 g (typ.)

Absolute Maximum Ratings (Ta = 25°C)

Characteristics		Symbol	Rating	Unit
LED	Forward current	I_F	30	mA
	Forward current derating (Ta>25°C)	$\Delta I_F/^\circ\text{C}$	-0.33	mA/°C
	Reverse voltage	V_R	5	V
Detector	Collector-emitter voltage	V_{CEO}	15	V
	Emitter-collector voltage	V_{ECO}	5	V
	Collector power dissipation	P_C	75	mW
	Collector power dissipation derating (Ta>25°C)	$\Delta P_C/^\circ\text{C}$	-1	mW/°C
	Collector current	I_C	50	mA
Operating temperature range		T_{opr}	-30 to 85	°C
Storage temperature range		T_{stg}	-40 to 100	°C
Soldering temperature (Note 1)		T_{sol}	250	°C

Marking (Note 2)

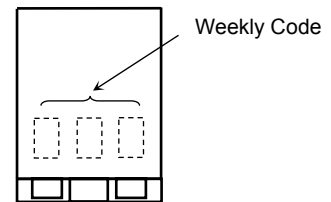

Note: Using continuously under heavy loads (e.g. the application of high temperature/current/voltage and the significant change in temperature, etc.) may cause this product to decrease in the reliability significantly even if the operating conditions (i.e. operating temperature/current/voltage, etc.) are within the absolute maximum ratings.

Please design the appropriate reliability upon reviewing the Toshiba Semiconductor Reliability Handbook ("Handling Precautions"/"Derating Concept and Methods") and individual reliability data (i.e. reliability test report and estimated failure rate, etc).

Note 1: The reflow time and the example of temperature profile are shown in the section entitled Mounting Method.

Note 2: Weekly code: (Three digits)

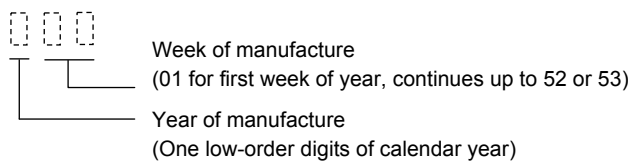

Optical and Electrical Characteristics (Ta = 25°C)

Characteristics		Symbol	Test conditions	Min	Typ.	Max	Unit	
LED	Forward voltage	V_F	$I_F = 10 \text{ mA}$	1.10	1.23	1.40	V	
	Reverse current	I_R	$V_R = 5 \text{ V}$	—	—	10	μA	
	Peak emission wavelength	λ_P	$I_F = 10 \text{ mA}$	—	940	—	nm	
Detector	Dark current	$I_D (I_{CEO})$	$V_{CE} = 12 \text{ V}, I_F = 0$	—	—	0.05	μA	
	Peak sensitivity wavelength	λ_P	—	—	820	—	nm	
Coupled	Current transfer ratio	I_C/I_F	$V_{CE} = 2 \text{ V}$ $I_F = 5 \text{ mA}$	TLP848	3	—	24	%
				TLP848 (R)	4	—	20	%
	Collector-emitter saturation voltage	$V_{CE(sat)}$	$I_F = 10 \text{ mA}, I_C = 0.15 \text{ mA}$	—	0.1	0.4	V	
	Rise time	t_r	$V_{CC} = 5 \text{ V}, I_C = 1 \text{ mA}$ $R_L = 1 \text{ k}\Omega$ (Note 3)	—	15	50	μs	
Fall time	t_f	—		15	50			

Note 3: Switching time measurement circuit and waveform

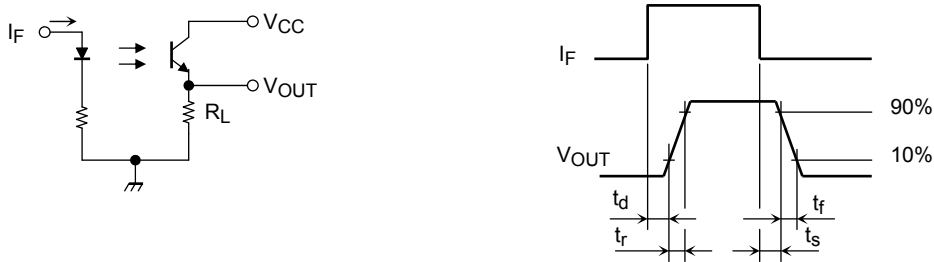

Handling and Mounting Precautions

- Care must be taken in relation to the environment in which the device is to be installed. Oil or chemicals may cause the package to melt or crack.
- The device should be mounted on an unwarped surface.
- Do not apply stress to the resin at high temperature.
- The resin part is easily scratched, so avoid friction with hard materials.
- When installing the assembly board in equipment, ensure that this product does not come into contact with other components.
- Conversion efficiency falls over time due to the current which flows in the infrared LED. When designing a circuit, take into account this change in conversion efficiency over time. The ratio of fluctuation in conversion efficiency to fluctuation in infrared LED optical output is 1:1.

$$\frac{IC/IF(t)}{IC/IF(0)} = \frac{P_o(t)}{P_o(0)}$$

Moisture-Proof Packing

- To avoid moisture absorption, the reel is packed in an aluminum bag that contains a desiccant with a humidity indicator. Since the optical characteristics of the photointerrupter may be affected during soldering by vaporization of the moisture which is absorbed in storable period, it should be stored under the following conditions:
 1. If the aluminum bag has been stored unopened
 - Temperature: 5 to 30°C
 - Relative humidity: 90% RH (max)
 - Time: 12 months
 2. If the aluminum bag has been opened
 - Temperature: 5 to 30°C
 - Relative humidity: 70% RH (max)
 - Time: 168 h
 3. Baking should be conducted within 72 h after the humidity indicator shows > 30% or the bag seal date is over 12 months. The number of baking should be once. If the baking is conducted repeatedly, it may affect the peel-back force and cause a problem for mounting.
 - Baking condition: 60 ± 5°C, 12 to 24 h
 - Storage period: 12 months from the seal date on the label
 4. When the photointerrupter is baked, protect it from electrostatic discharge.
 5. Do not toss or drop to avoid damaging the moisture-proof bag.

Mounting Methods

1. The example of temperature profile (reflow soldering)

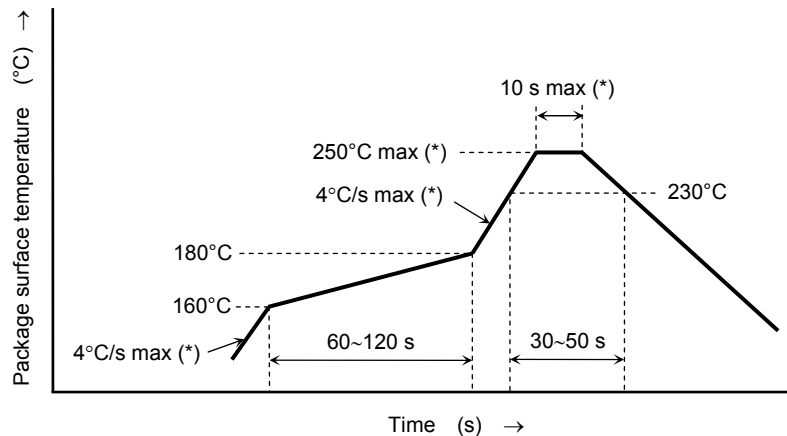

(*)The product is evaluated using above reflow soldering conditions. No additional test is performed exceed the condition (i.e. the condition more than MAX values) as an evaluation. Please perform reflow soldering under the above conditions.

- The first reflow process should be performed under the above temperature profile within 168 h after opening the bag.
- If a second reflow process needs to be performed, it should be performed within 168 h of the first reflow under the above temperature profile.
- Storage conditions before the second reflow process: 30°C, 70% RH (max)
- Do not perform wave soldering and manual soldering with a soldering iron.

2. Recommended soldering pattern

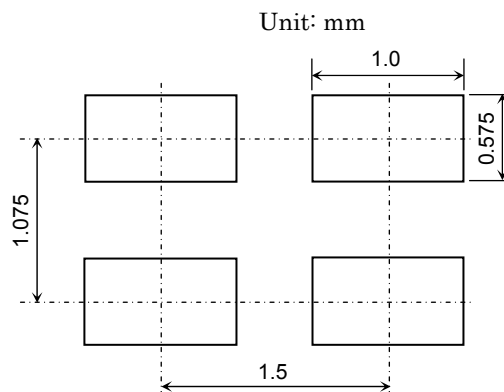

3. Cleaning

When cleaning is required after soldering, Toshiba recommends the following cleaning solvents. It is confirmed that these solvents have no effect on semiconductor devices in our dipping test (under the recommended conditions). In selecting the one for your actual usage, please perform sufficient review on washing condition, using condition and etc.

- | | |
|--|----------------------------------|
| ASAHI CLEAN AK-225AES | : (made by ASAHI GLASS) |
| KAO CLEAN TROUGH 750H | : (made by KAO) |
| PINE ALPHA ST-100S | : (made by ARAKAWA CHEMICAL) |
| TOSHIBA TECHNOCARE
(FRW-17, FRW-1, FRV-100) | : (made by GE TOSHIBA SILICONES) |

Packing Specification

1. Tape dimensions

Unit: mm

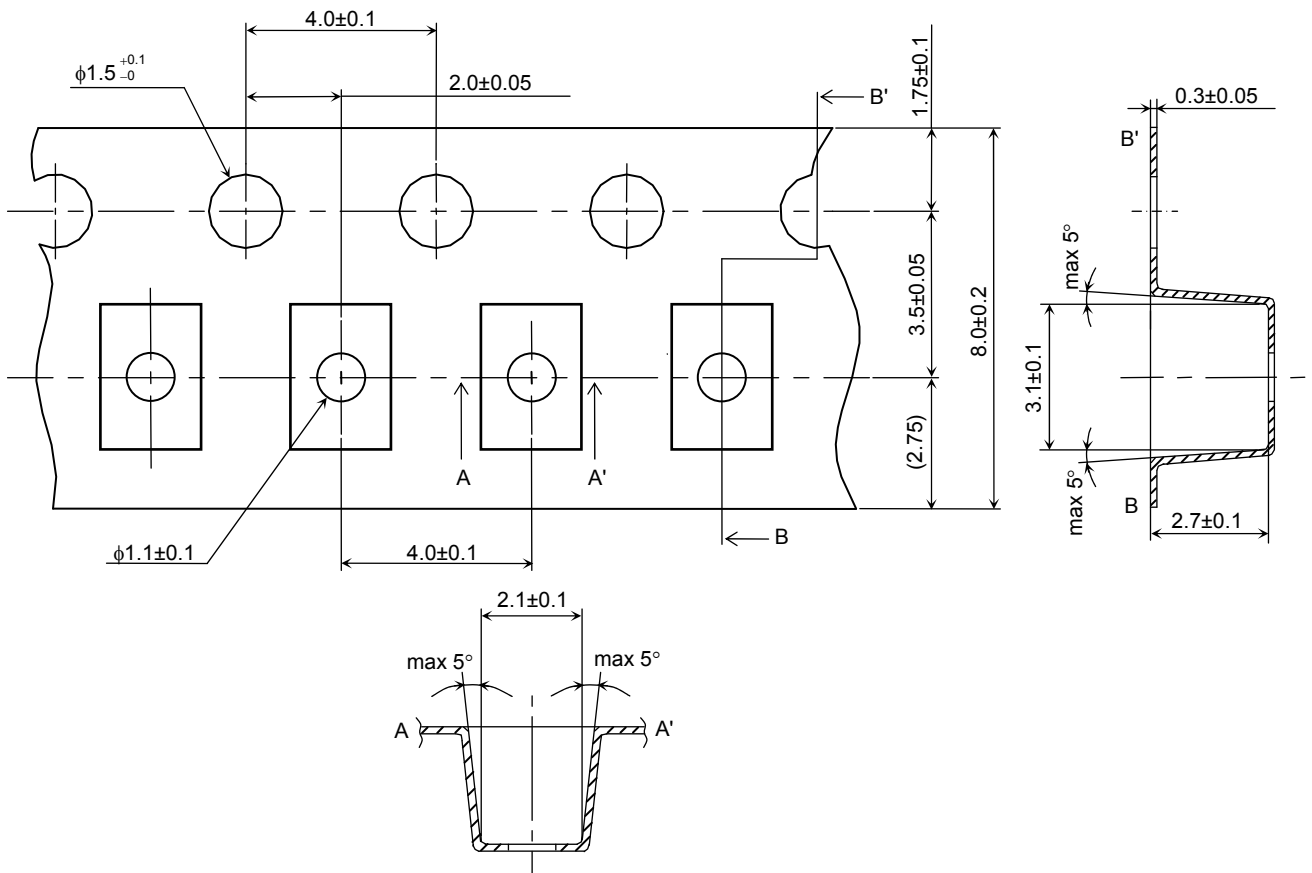

Device direction

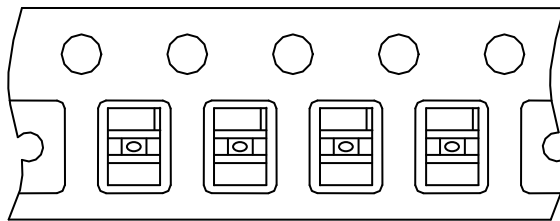

2. Reel dimensions

Unit: mm

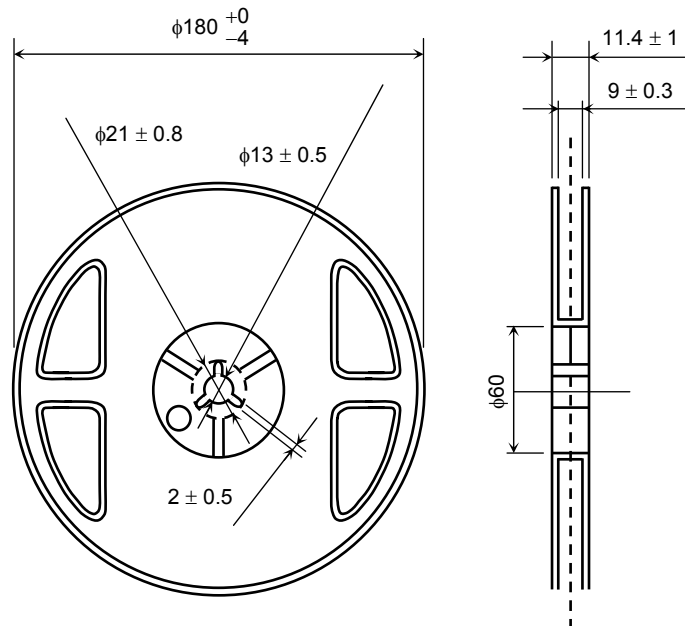

3. Leader and trailer sections of tape

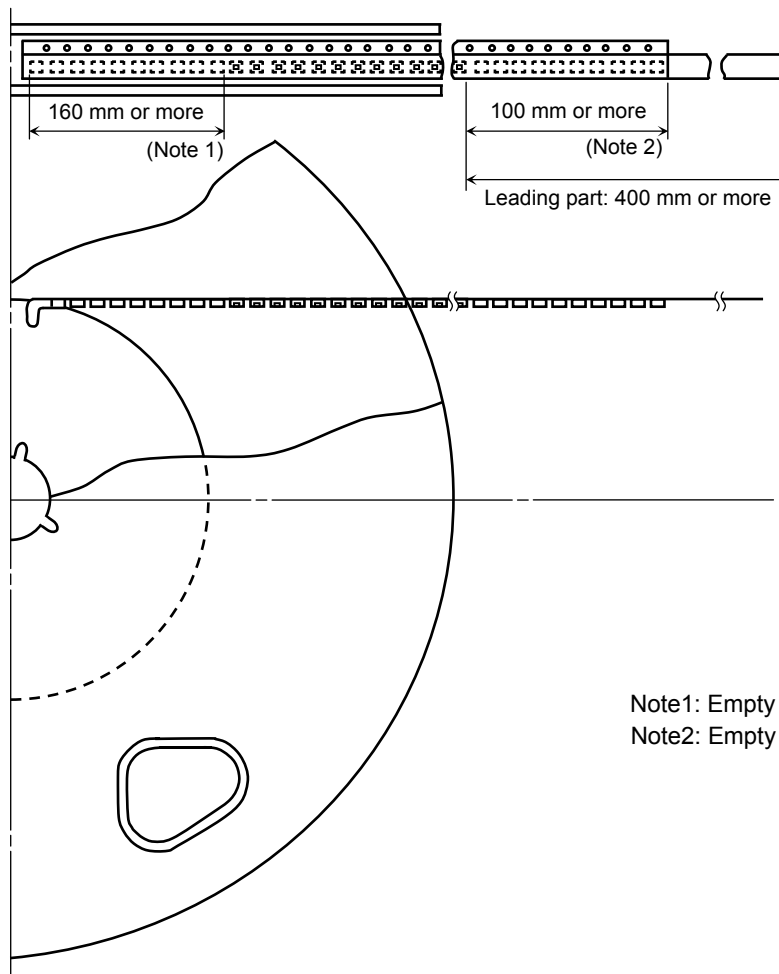

4. Packing format

(1) Packing quantity

Reel	1,500 pcs
Carton	7,500 pcs

(2) Packing form

Each reel is sealed in an aluminum bag that contains a desiccant with a humidity indicator.

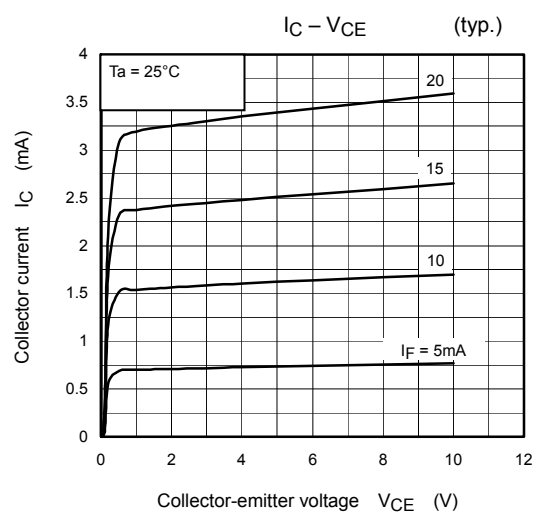
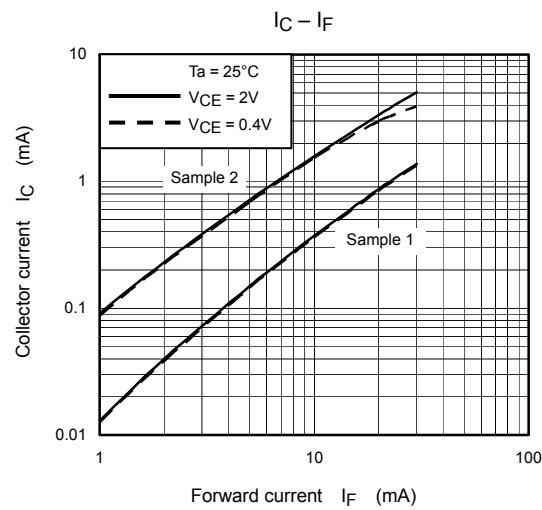
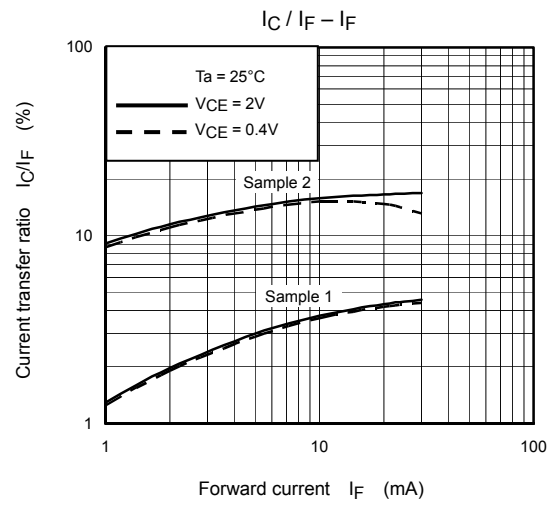
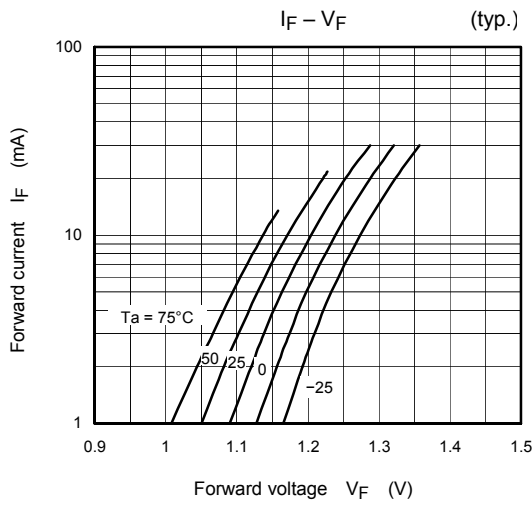
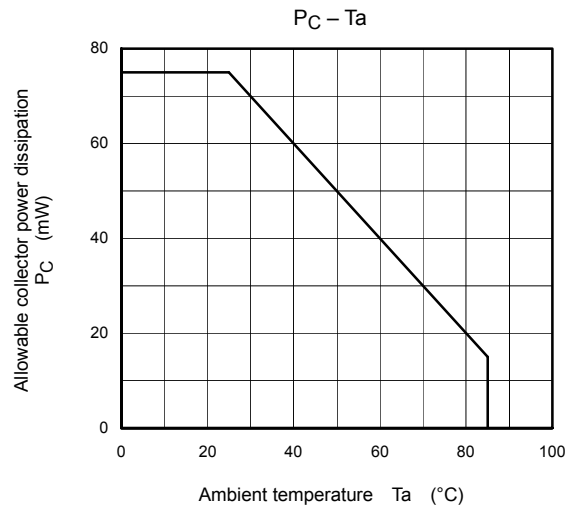
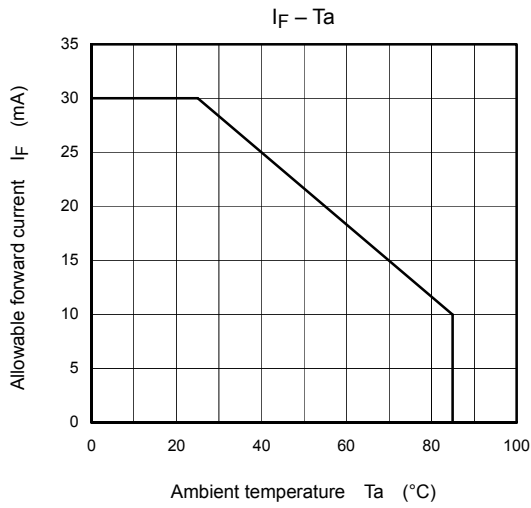

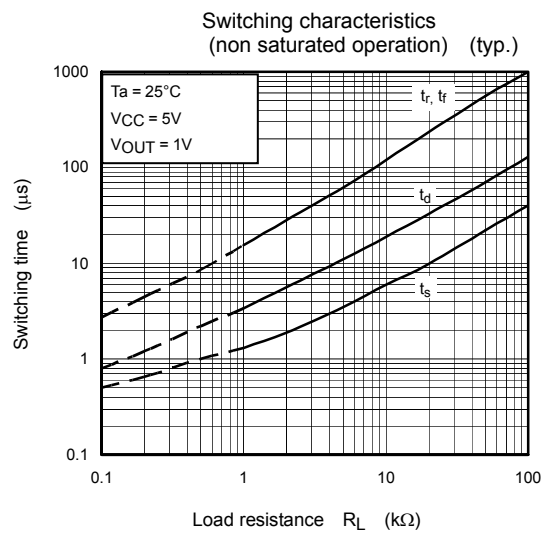
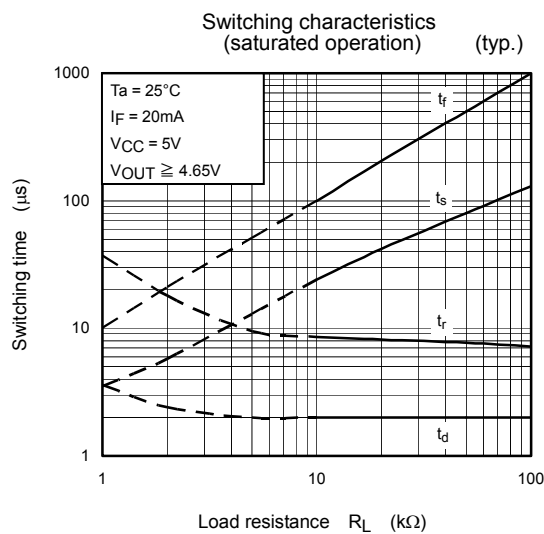
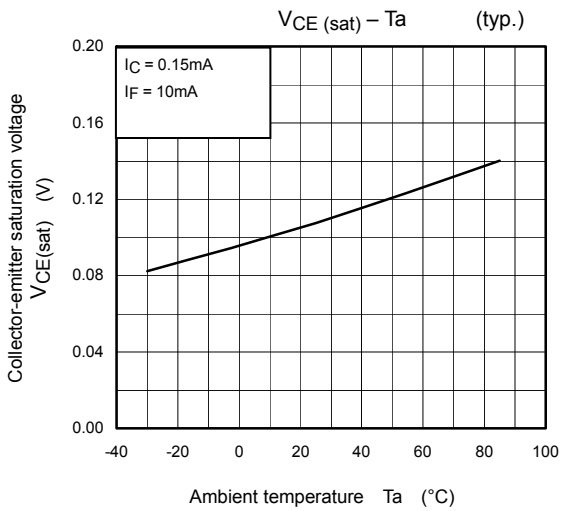
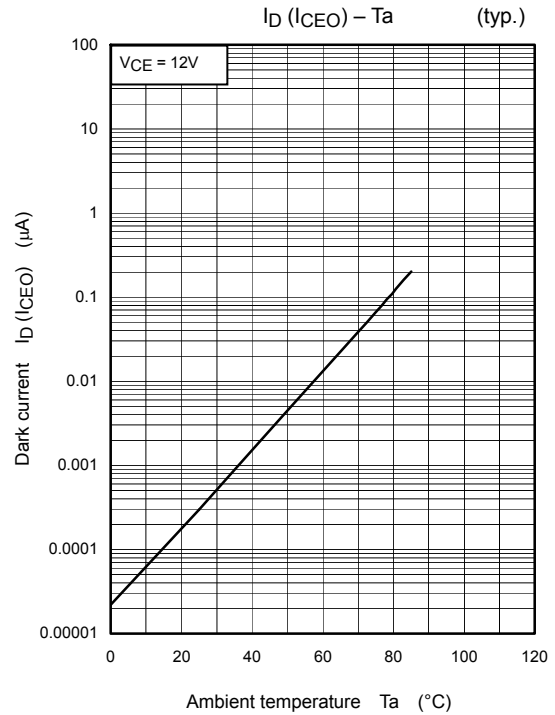
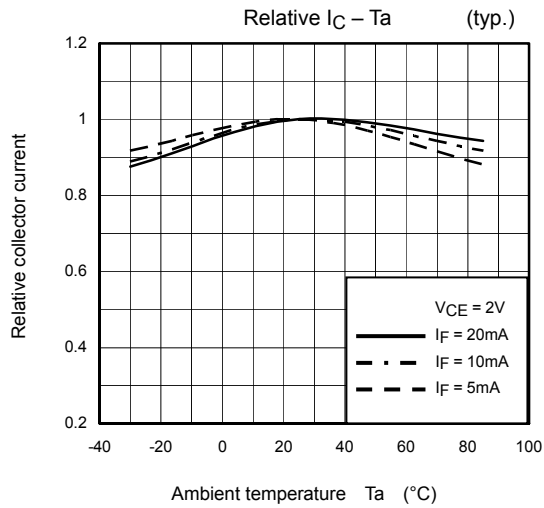

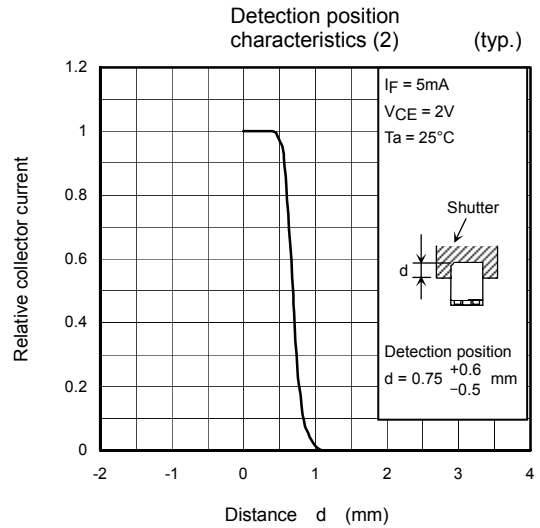
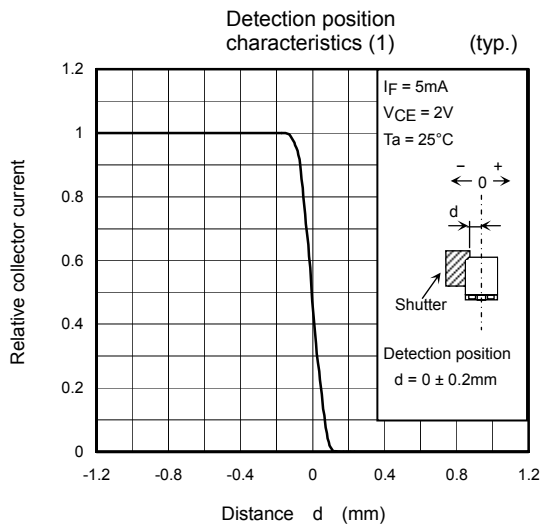

Relative Positioning of Shutter and Device

For normal operation, position the shutter and the device as shown in the figure below. By considering the device's detection direction characteristic and switching time, determine the shutter slit width and pitch.

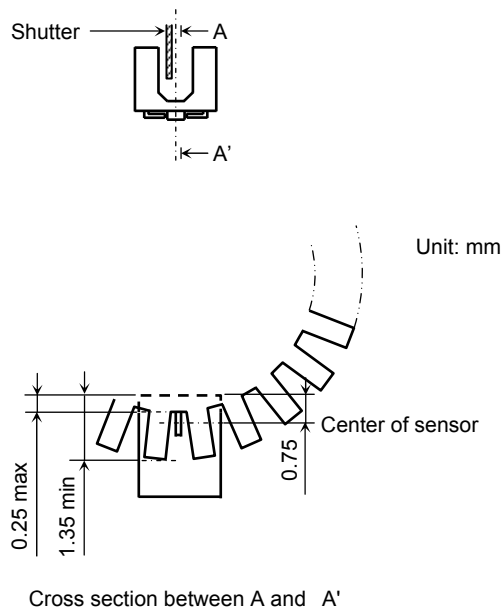

RESTRICTIONS ON PRODUCT USE

20070701-EN

- The information contained herein is subject to change without notice.
- TOSHIBA is continually working to improve the quality and reliability of its products. Nevertheless, semiconductor devices in general can malfunction or fail due to their inherent electrical sensitivity and vulnerability to physical stress. It is the responsibility of the buyer, when utilizing TOSHIBA products, to comply with the standards of safety in making a safe design for the entire system, and to avoid situations in which a malfunction or failure of such TOSHIBA products could cause loss of human life, bodily injury or damage to property.
In developing your designs, please ensure that TOSHIBA products are used within specified operating ranges as set forth in the most recent TOSHIBA products specifications. Also, please keep in mind the precautions and conditions set forth in the "Handling Guide for Semiconductor Devices," or "TOSHIBA Semiconductor Reliability Handbook" etc.
- The TOSHIBA products listed in this document are intended for usage in general electronics applications (computer, personal equipment, office equipment, measuring equipment, industrial robotics, domestic appliances, etc.). These TOSHIBA products are neither intended nor warranted for usage in equipment that requires extraordinarily high quality and/or reliability or a malfunction or failure of which may cause loss of human life or bodily injury ("Unintended Usage"). Unintended Usage include atomic energy control instruments, airplane or spaceship instruments, transportation instruments, traffic signal instruments, combustion control instruments, medical instruments, all types of safety devices, etc.. Unintended Usage of TOSHIBA products listed in this document shall be made at the customer's own risk.
- The products described in this document shall not be used or embedded to any downstream products of which manufacture, use and/or sale are prohibited under any applicable laws and regulations.
- The information contained herein is presented only as a guide for the applications of our products. No responsibility is assumed by TOSHIBA for any infringements of patents or other rights of the third parties which may result from its use. No license is granted by implication or otherwise under any patents or other rights of TOSHIBA or the third parties.
- GaAs(Gallium Arsenide) is used in this product. The dust or vapor is harmful to the human body. Do not break, cut, crush or dissolve chemically.
- Please contact your sales representative for product-by-product details in this document regarding RoHS compatibility. Please use these products in this document in compliance with all applicable laws and regulations that regulate the inclusion or use of controlled substances. Toshiba assumes no liability for damage or losses occurring as a result of noncompliance with applicable laws and regulations.