

CMOS 4-Bit Microcontroller

TMP47P422VN
TMP47P422VF
TMP47P422VU

The TMP47P422V is the system evaluation LSI of TMP47C222/422 with a 32 Kbit one-time PROM. The TMP47P422V programs / verifies using an adapter socket to connect with PROM programmer, as it is in TMM27256AD.

In addition, the TMP47P422V and the TMP47C222/422 are pin compatible. The TMP47P422V operates as the same as the TMP47C222/422 by programming to the internal PROM.

Part No.	EPROM	RAM	Package	Adapter Socket
TMP47P422VN	OTP		P-SDIP42-600-1.78	BM11102
TMP47P422VF	4096 x 8-bit	256 x 4-bit	P-QFP44-1414-0.80D	BM11103
TMP47P422VU			P-QFP44-1010-0.80	BM11170

Pin Assignment (Top View)

P-SDIP42-600-1.78

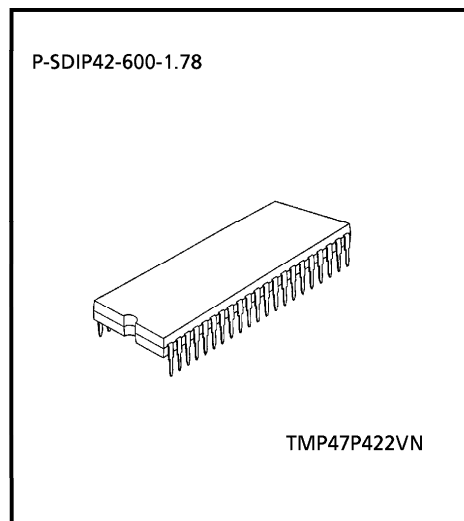
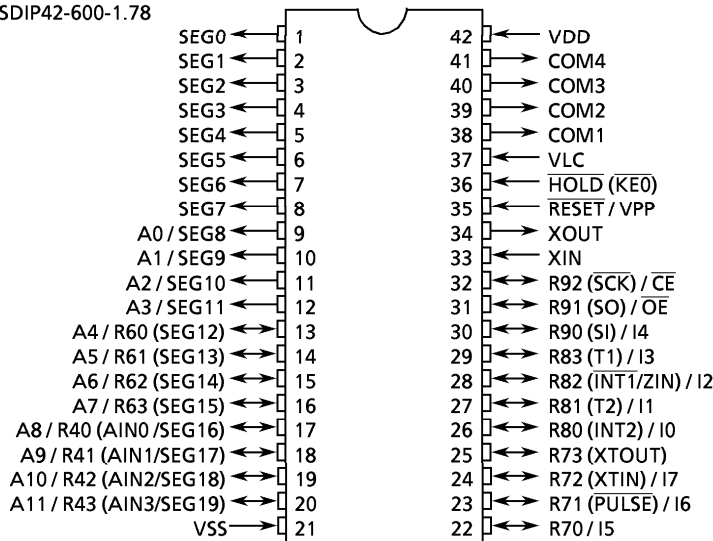

000707EBA1

- For a discussion of how the reliability of microcontrollers can be predicted, please refer to Section 1.3 of the chapter entitled Quality and Reliability Assurance / Handling Precautions.
- TOSHIBA is continually working to improve the quality and reliability of its products. Nevertheless, semiconductor devices in general can malfunction or fail due to their inherent electrical sensitivity and vulnerability to physical stress. It is the responsibility of the buyer, when utilizing TOSHIBA products, to comply with the standards of safety in making a safe design for the entire system, and to avoid situations in which a malfunction or failure of such TOSHIBA products could cause loss of human life, bodily injury or damage to property. In developing your designs, please ensure that TOSHIBA products are used within specified operating ranges as set forth in the most recent TOSHIBA products specifications. Also, please keep in mind the precautions and conditions set forth in the "Handling Guide for Semiconductor Devices," or "TOSHIBA Semiconductor Reliability Handbook" etc..
- The TOSHIBA products listed in this document are intended for usage in general electronics applications (computer, personal equipment, office equipment, measuring equipment, industrial robotics, domestic appliances, etc.). These TOSHIBA products are neither intended nor warranted for usage in equipment that requires extraordinarily high quality and/or reliability or a malfunction or failure of which may cause loss of human life or bodily injury ("Unintended Usage"). Unintended Usage include atomic energy control instruments, airplane or spaceship instruments, transportation instruments, traffic signal instruments, combustion control instruments, medical instruments, all types of safety devices, etc.. Unintended Usage of TOSHIBA products listed in this document shall be made at the customer's own risk.
- The products described in this document are subject to the foreign exchange and foreign trade laws.
- The information contained herein is presented only as a guide for the applications of our products. No responsibility is assumed by TOSHIBA CORPORATION for any infringements of intellectual property or other rights of the third parties which may result from its use. No license is granted by implication or otherwise under any intellectual property or other rights of TOSHIBA CORPORATION or others.
- The information contained herein is subject to change without notice.

Pin Assignment (Top View)

P-QFP44-1414-0.80D
P-QFP44-1010-0.80

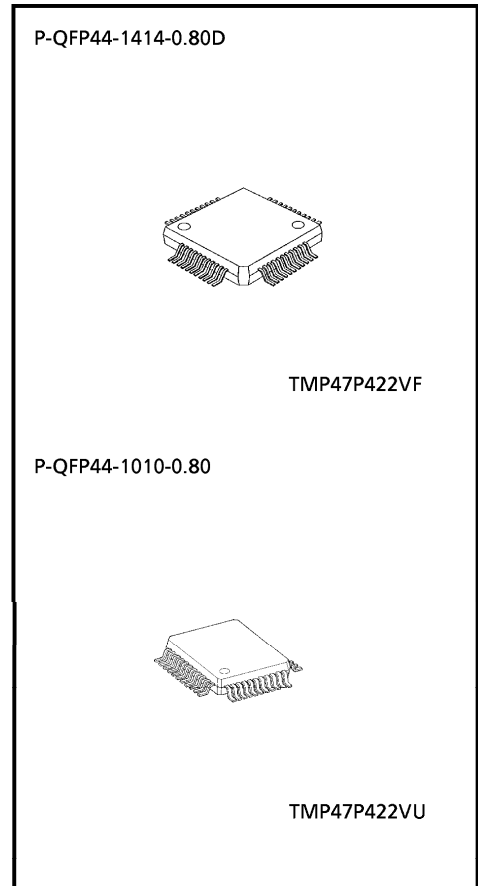
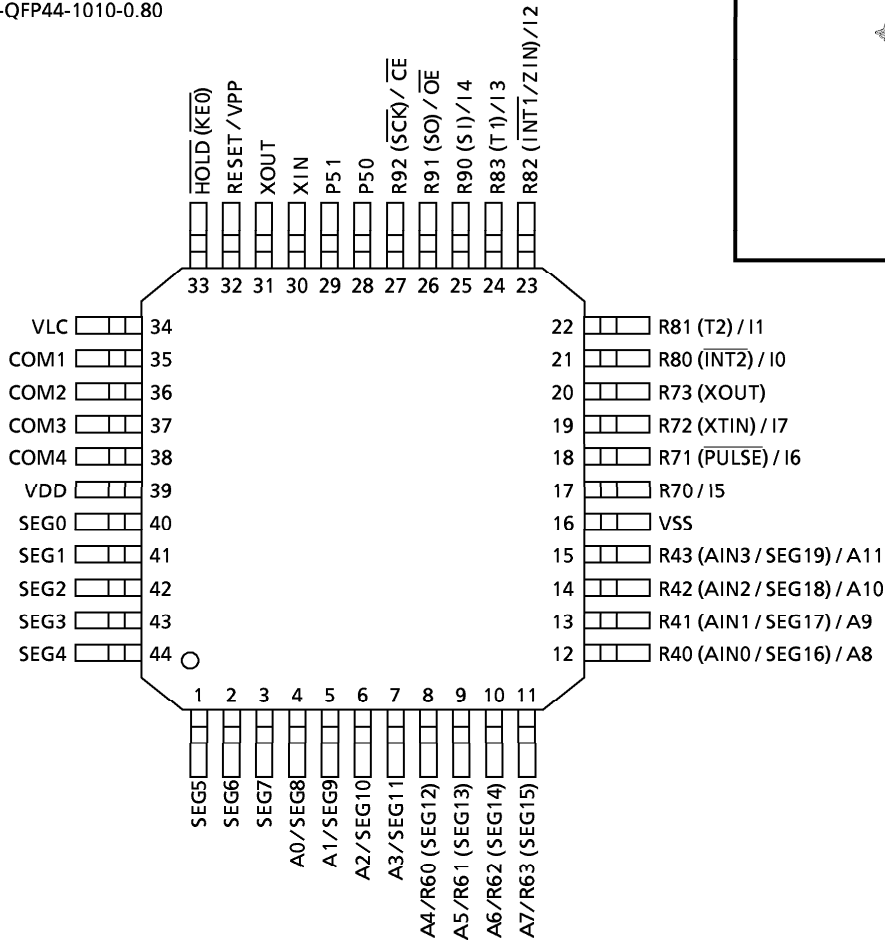

Pin Function

The TMP47P422V has MCU mode and PROM mode.

(1) MCU mode

The TMP47C222/422 and the TMP47P422V are pin compatible.

(2) PROM mode

Pin Name	Input / Output	Functions	Pin Name (MCU mode)
A11 to A8	Input	Address inputs	R43 to R40
A7 to A4			R63 to R60
A3 to A0			SEG11 to SEG8
I7 to I5	I/O	Data inputs / outputs	R72 to R70
I4			R90
I3 to I0			R83 to R80
\overline{CE}	Input	Chip Enable input	R92
\overline{OE}		Output Enable input	R91
VPP	Power supply	+ 12.5 V / 5 V (Program supply voltage)	\overline{RESET}
VCC		+ 5 V	VDD
VSS		0 V	VSS
\overline{HOLD}	Input	PROM mode setting pin. Be fixed to low level.	
XIN	Input	Input the clock from the external oscillator. (8 MHz typ.)	
XOUT	Input	Be pulled down to VSS level. (750 Ω typ.)	
SEG7 to SEG0	Output	Open	
COM4 to COM0			
VLC	Power supply	Be fixed to VSS level.	

Operational Description

The following is an explanation of hardware configuration and operation in relation to the TMP47P422V. The TMP47P422V is the same as the TMP47C222/422 except that an OTP is used instead of a built-in mask ROM.

1. Operation mode

The TMP47P422V has a MCU mode and a PROM mode.

1.1 MCU mode

The MCU mode is set by attaching a resonator between the XIN and Xout pins. Operation in the MCU mode is the same as for the TMP47C222/422. In the TMP47P422V, RC oscillation is impossible.

1.1.1 Program Memory

The program storage area is the same as for the TMP47C422.

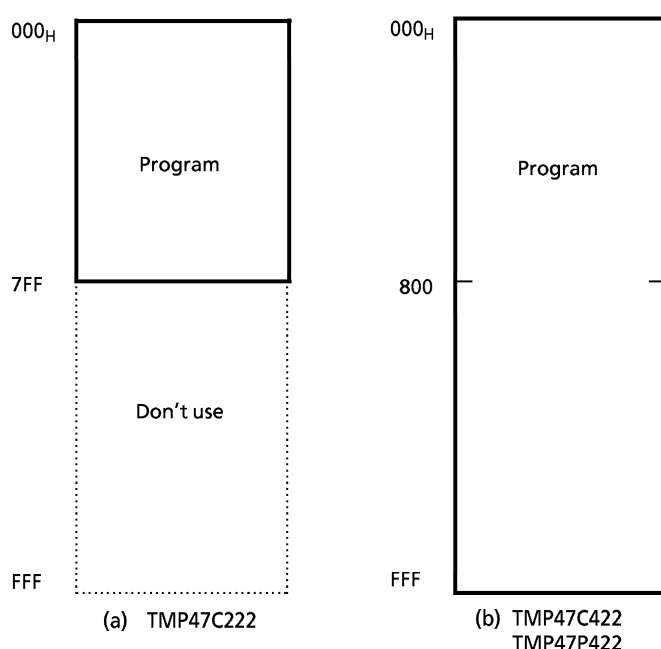

Figure 1-1. Program area (ROM)

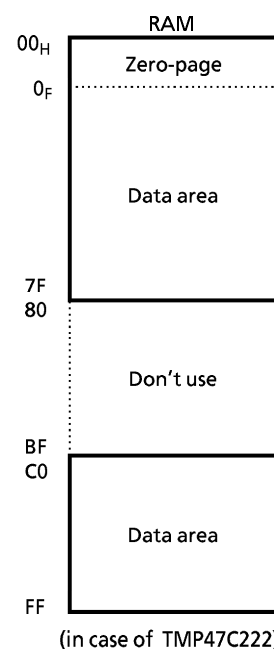

Figure 1-2. RAM addressing

1.1.2 Data Memory

The TMP47P422V contains 256 × 4-bit (equivalent to TMP47C422) data memory. When the TMP47P422V is used as evaluator of the TMP47C222, programming should be performed assuming that the RAM is assigned to addresses 00 to 7F_H and C0 to FF_H as show in Figure 1-2 by considering the application software evaluation. When the BM47C422 (emulator) is used as the TMP47C222 evaluator, it is sam.

1.1.3 Input / Output Circuitry

(1) Control pins

TMP47P422V is the same as code SA of the TMP47C222/422. In the TMP47P422V, RC oscillation is impossible. Connecting the resonator or inputting the external clock to XIN pin are required when using as evaluator of I/O code SD.

(2) I/O Ports

The input / output circuit of the TMP47P422V is the same as the TMP47C222/422.

1.2 PROM mode

The PROM mode is set by inputting the external clock to the XIN pin when XOUT pin is pulled down to the VSS level. In PROM mode, programs can be written or verified using a general-purpose PROM writer with an adapter socket being attached.

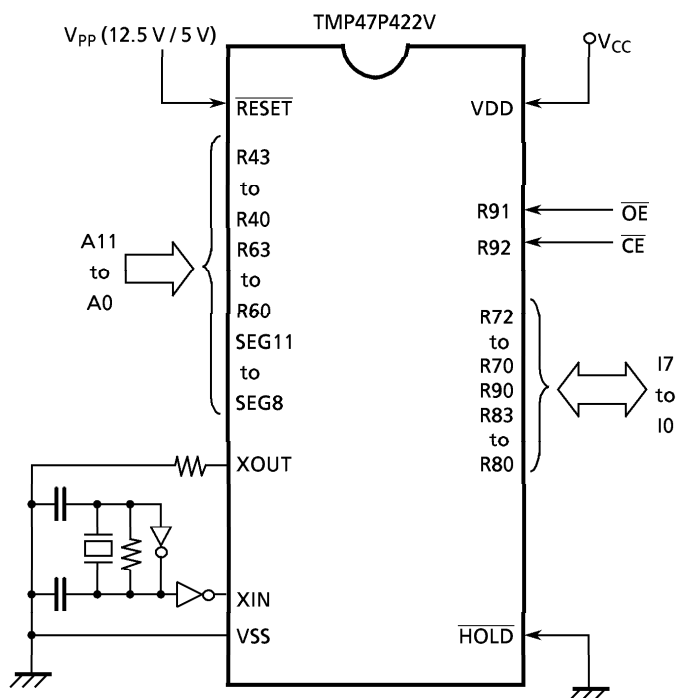

Figure 1-3. Setting for PROM mode

1.2.1 Program Writing

When writing a program, set a ROM type to "27256AD" (programming voltage: 12.5 V). Since the TMP47P422V has a 4096×8 -bit internal PROM (000 to FFF_H), set a stop address of a PROM writer to "FFF_H". For a general-purpose PROM writer, use the writer which does not have or can release an electric signature mode.

Note: When the data written to OTP is same as the data of PROM programmer, there is the possibility that the security writing can not be executed, which is depended on the types of PROM programmers.

In this case, set the data of PROM programmer to "00" and execute the security writing after writing the data to OTP.

1.2.2 High Speed Programming Mode

The program time can be greatly decreased by using this high speed programming mode. The device is set up in the high speed programming mode when the programming voltage (+ 12.5 V) is applied to the V_{PP} terminal with $V_{CC} = 6 V$ and $\overline{CE} = V_{IH}$.

The programming is achieved by applying a single low level 1 ms pulse the \overline{CE} input after addresses and data are stable. Then the programmed data is verified by using Program Verify Mode.

If the programmed data is not correct, another program pulse of 1ms is applied and then programmed data is verified. This should be repeated until the program operates correctly (max. 25 times).

After correctly programming the selected address, one additional program pulse with pulse width 3 times that needed for programming is applied.

When programming has been completed, the data in all addresses should be verified with $V_{CC} = V_{PP} = 5 V$.

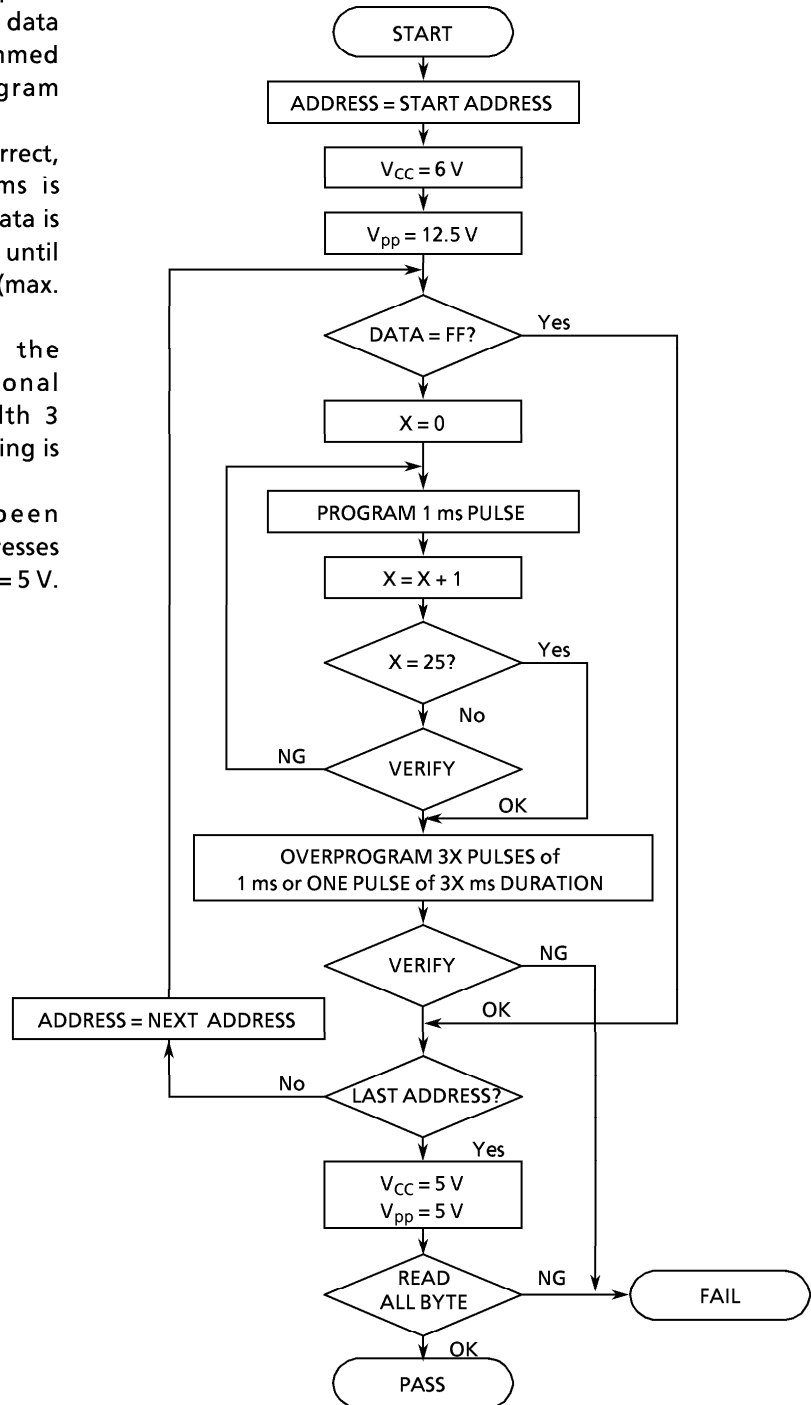

Figure 1-6. Flowchart

Electrical Characteristics

Absolute Maximum Ratings (V_{SS} = 0 V)

Parameter	Symbol	Pins	Ratings	Unit
Supply Voltage	V _{DD}		- 0.3 to 6.5	V
Program Voltage	V _{PP}	RESET / VPP pin	- 0.3 + 13.0	V
Input Voltage	V _{IN}		- 0.3 to V _{DD} + 0.3	V
Output Voltage	V _{OUT}		- 0.3 to V _{DD} + 0.3	V
Output Current (Per 1 pin)	I _{OUT1}	Port R4, R7	30	mA
	I _{OUT2}	Port R5, R6, R8, R9	120	
Output Current	ZI _{OUT}	Port R4, R7	120	mA
Power Dissipation [Topr = 70°C]	PD		400	mW
Soldering Temperature (time)	Tsld		260 (10 s)	°C
Storage Temperature	Tstg		- 55 to 125	°C
Operating Temperature	Topr		- 30 to 70	°C

Note: The absolute maximum ratings are rated values which must not be exceeded during operation, even for an instant. Any one of the ratings must not be exceeded. If any absolute maximum rating is exceeded, a device may break down or its performance may be degraded, causing it to catch fire or explode resulting in injury to the user. Thus, when designing products which include this device, ensure that no absolute maximum rating value will ever be exceeded.

Recommended Operating Conditions (V_{SS} = 0 V, Topr = - 30 to 70°C)

Parameter	Symbol	Pins	Conditions	Min	Max	Unit
Supply Voltage	V _{DD}		fc = 8.0 MHz	2.7	5.5	V
			fc = 4.2 MHz	2.2		
			In the SLOW mode	2.2		
			In the HOLD mode	2.0		
Input High Voltage	V _{IH1}	Except Hysteresis Input	In the normal operating area	V _{DD} × 0.7	V _{DD}	V
	V _{IH2}	Hysteresis Input		V _{DD} × 0.75		
	V _{IH3}		In the HOLD mode	V _{DD} × 0.9		
Input Low Voltage	V _{IL1}	Except Hysteresis Input	In the normal operating area	0	V _{DD} × 0.3	V
	V _{IL2}	Hysteresis Input			V _{DD} × 0.25	
	V _{IL3}		In the HOLD mode		V _{DD} × 0.1	
Clock Frequency	fc	XIN, XOUT	V _{DD} = 2.7 to 5.5 V	0.4	8.0	MHz
			V _{DD} = 2.2 to 5.5 V		4.2	
	fs	XTIN, XTOUT	V _{DD} = 2.2 to 5.5 V	30	34	kHz

Note: The recommended operating conditions for a device are operating conditions under which it can be guaranteed that the device will operate as specified. If the device is used under operating conditions other than the recommended operating conditions (supply voltage, operating temperature range, specified AC/DC values etc.), malfunction may occur. Thus, when designing products which include this device, ensure that the recommended operating conditions for the device are always adhered to.

DC Characteristics

(V_{SS} = 0 V, Topr = -30 to 70°C)

Parameter	Symbol	Pins	Conditions	Min	Typ.	Max	Unit	
Hysteresis Voltage	V _{HS}	Hysteresis Input		-	0.7	-	V	
Input Current	I _{IN1}	RESET, HOLD	V _{DD} = 5.5 V, V _{IN} = 5.5 V / 0 V	-	-	± 2	μA	
	I _{IN2}	Open drain output ports						
Input Resistance	R _{IN}	RESET		100	220	450	kΩ	
Output Leakage Current	I _{LO}	Open drain output ports	V _{DD} = 5.5 V, V _{OUT} = 5.5 V	-	-	2	μA	
Output Low Current	I _{OL2}	Port R4, R7	V _{DD} = 4.5 V, V _{OL} = 1.0 V	7	10	-	mA	
Output Low Voltage	V _{OL}	Port R4, P5, R6, R7, R8, R9	V _{DD} = 4.5 V, I _{OL} = 1.6 mA	-	-	0.4	V	
			V _{DD} = 2.2 V, I _{OL} = 20 μA	-	-	0.1		
Segment Output Low Resistance	R _{OS1}	SEG pin	V _{DD} = 5 V, V _{DD} - V _{LC} = 3 V	-	10 or 20	-	kΩ	
Common Output Low Resistance	R _{OC1}	COM pin						
Segment Output High Resistance	R _{OS2}	SEG pin						
Common Output High Resistance	R _{OC2}	COM pin						
Segment/Common Output Resistance	V _{O2/3}	SEG / COM pin			3.8	4.0	4.2	
	V _{O1/2}							V
	V _{O1/3}							
Supply Current (in the Normal mode)	I _{DD}		V _{DD} = 5.5 V, f _c = 4 MHz	-	2	4	mA	
			V _{DD} = 3.0 V, f _c = 4 MHz	-	1	2		
			V _{DD} = 3.0 V, f _c = 400 kHz	-	0.5	1		
Supply Current (in the SLOW mode)	I _{DDS}		V _{DD} = 3.0 V, f _s = 32.768 kHz	-	20	40	μA	
Supply Current (in the HOLD mode)	I _{DDH}		V _{DD} = 5.5 V	-	0.5	10	μA	

Note 1: Typ. values show those at Topr = 25°C, V_{DD} = 5 V.

Note 2: Input Current I_{IN1}: The current through resistor is not included.

Note 3: Output Resistance R_{OS}, R_{OC}; Shows on-resistance at the level switching.

Note 4: V_{O2/3}; Shows 2/3 level output voltage, when the 1/4 or 1/3 duty LCD is used.

V_{O1/2}; Shows 1/2 level output voltage, when the 1/2 duty or static LCD is used.

V_{O1/3}; Shows 1/3 level output voltage, when the 1/4 or 1/3 duty LCD is used.

Note 5: Supply Current I_{DD}, I_{DDH}: V_{IN} = 5.3 V / 0.2 V (V_{DD} = 5.5 V), 2.8 V / 0.2 V (V_{DD} = 3.0 V)

Supply Current I_{DDS}; V_{IN} = 2.8 V / 0.2 V. Low frequency clock is only oscillated.

Note 6: When using LCD, it is necessary to consider values of Ros 1/2 and Roc 1/2.

Note 7: Times for SEG/COM output switching on; Ros1, Roc1: 2/f_c (s)

Ros2, Roc2: 1/(n · f_F) (1/n; duty, f_F: frame frequency)

AD Conversion Characteristics

(Topr = -30 to 70°C)

Parameter	Symbol	Conditions	Min	Typ.	Max	Unit
Analog Reference Voltage Range	ΔV_{AREF}	$V_{DD} - V_{SS}$	2.7	—	—	V
Analog Input Voltage	V_{AIN}		V_{SS}	—	V_{DD}	V
Analog Supply current	I_{REF}		—	0.5	1.0	mA
Nonlinearity Error		$V_{DD} = 2.7\text{ V to } 5.5\text{ V}$ $V_{SS} = \pm 0.000\text{ V}$	—	—	± 1	LSB
Zero Point Error			—	—	± 1	
Full Scale Error			—	—	± 1	
Total Error			—	—	± 2	

AC Characteristics

(V_{SS} = 0 V, Topr = -30 to 70°C)

Parameter	Symbol	Conditions	Min	Typ.	Max	Unit	
Instruction Cycle Time	tcy	In the normal mode	$V_{DD} = 2.7\text{ to } 5.5\text{ V}$	1.0	—	20	μs
			$V_{DD} = 2.2\text{ to } 5.5\text{ V}$	1.9			
		In the SLOW mode			235		
High level clock pulse width	t_{WCH}	For external clock (XIN input)	$V_{DD} \geq 2.7\text{ V}$	60	—	—	ns
	$V_{DD} < 2.7\text{ V}$		120				
Low level clock pulse width	t_{WCL}		$V_{DD} \geq 2.7\text{ V}$	60			
	$V_{DD} < 2.7\text{ V}$		120				
AD Conversion Time	t_{ADC}		—	24 tcy	—	μs	
AD Sampling Time	t_{AIN}		—	2 tcy	—		
Shift data Hold Time	t_{SDH}		0.5 tcy - 0.3	—	—	μs	

Note 1: AD conversion timing:

Internal circuit for pins AIN0 to 7

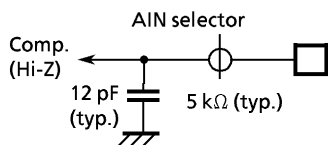

* Electrical change must be loaded into the built-in condensen during t_{AIN} for normal AD conversion.

AD conversion timing

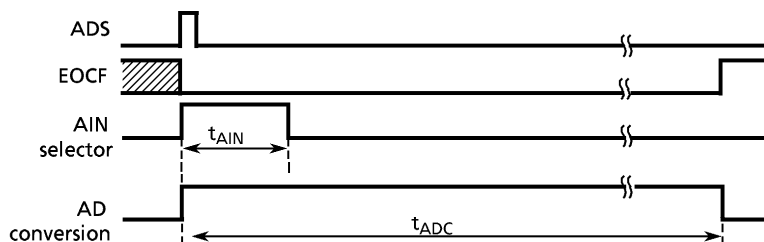

Note2: Shift data Hold Time:
External circuit for pins
 $\overline{\text{SCK}}$ and SO

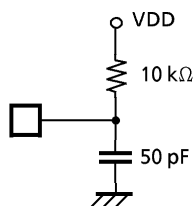

Serial port (completed of transmission)

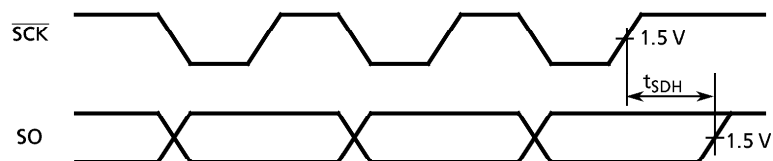

Zero-Cross Detection Characteristics

($V_{SS} = 0 \text{ V}$, $T_{opr} = -30 \text{ to } 70 \text{ }^\circ\text{C}$)

Characteristics are equivalent to the TMP47C222/422's.

Recommended Oscillating Conditions

($V_{SS} = 0 \text{ V}$, $V_{DD} = 2.2 \text{ to } 5.5 \text{ V}$, $T_{opr} = -30 \text{ to } 70 \text{ }^\circ\text{C}$)

Recommended oscillating conditions of the TMP47P422V are equal to the TMP47C222/422's but RC oscillation is impossible.

DC/AC Characteristics

(V_{SS} = 0 V)

(1) Read Operation

Parameter	Symbol	Condition	Min	Typ.	Max	Unit
Output Level High Voltage	V _{IH4}		V _{CC} × 0.7	–	V _{CC}	V
Output Level Low Voltage	V _{IL4}		0	–	V _{CC} × 0.3	V
Supply Voltage	V _{CC}		4.75	–	6.0	V
Programming Voltage	V _{PP}					
Address Access Time	t _{ACC}	V _{CC} = 5.0 ± 0.25 V	0	–	350	ns

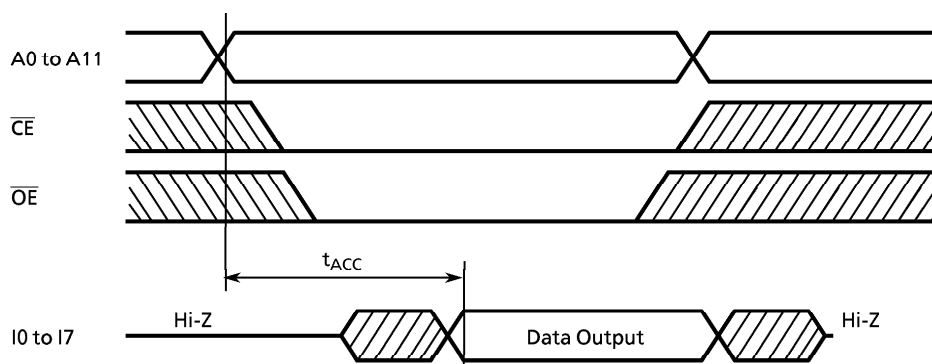

(2) High Speed Programming Operation

Parameter	Symbol	Condition	Min	Typ.	Max	Unit
Input High Voltage	V_{IH4}		$V_{CC} \times 0.7$	–	V_{CC}	V
Input Low Voltage	V_{IL4}		0	–	$V_{CC} \times 0.3$	V
Supply Voltage	V_{CC}		4.75	–	6.0	V
V_{PP} Power Supply Voltage	V_{PP}		12.00	12.50	13.00	V
Programming Pulse Width	t_{PW}	$V_{CC} = 6.0 \pm 0.25 V$	0.95	1.0	1.05	ms

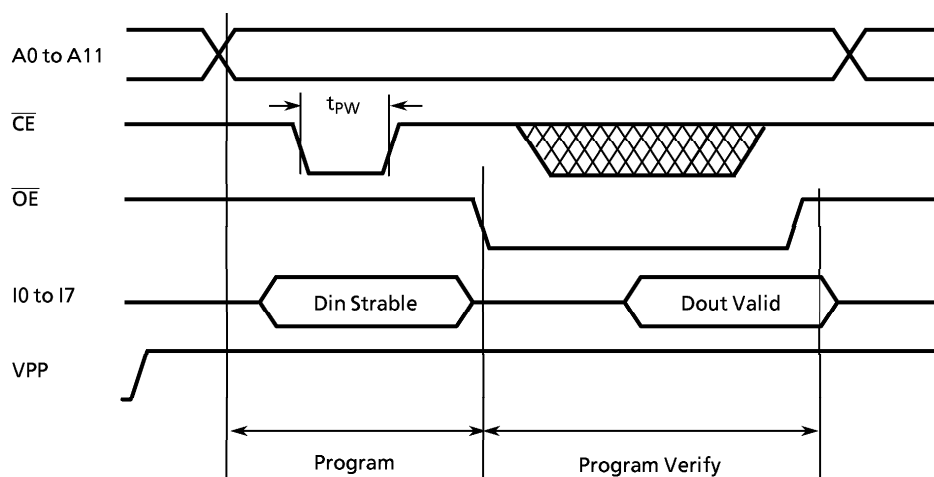

Note: There are some PROM programmer types which cannot program OTP.
 In TMP47P422V, VPP pin is also used as RESET pin. To set a mode, REST/VPP pin must be set to "low" during 1 ms and more after the rising of power-on and the rising of VDD electrical power.

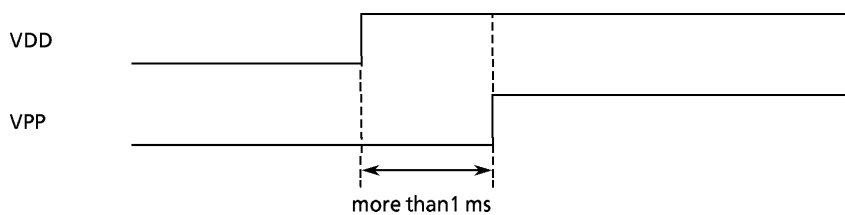

Recommended EPROM programmer

- TYPE
- R4945 (ADVANTEST)
- UNISITE (DATA I/O)
- AF – 9706 (ANDO)
- PECKER – 11 (AVAL DATA)