

SKiiP 24NAB126V10



MiniSKiiP[®] 2

3-phase bridge rectifier +
brake chopper + 3-phase
bridge inverter
SKiiP 24NAB126V10

Preliminary Data

Features

- Fast Trench IGBTs
- Robust and soft freewheeling diodes in CAL technology
- Highly reliable spring contacts for electrical connections
- UL recognised file no. E63532

Typical Applications

- Inverter up to 19 kVA
- Typical motor power 11 kW

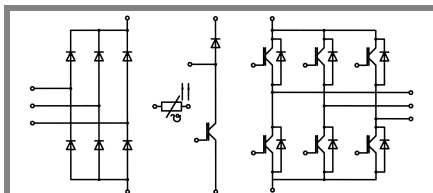

NAB

Absolute Maximum Ratings		$T_s = 25\text{ °C}$, unless otherwise specified	
Symbol	Conditions	Values	Units
IGBT - Inverter, Chopper			
V_{CES}		1200	V
I_C	$T_s = 25\text{ (70) °C}$	52 (40)	A
I_{CRM}	$T_s = 25\text{ (70) °C}$, $t_p \leq 1\text{ ms}$	104 (80)	A
V_{GES}		± 20	V
T_j		- 40 ... + 150	°C
Diode - Inverter, Chopper			
I_F	$T_s = 25\text{ (70) °C}$	38 (29)	A
I_{FRM}	$T_s = 25\text{ (70) °C}$, $t_p \leq 1\text{ ms}$	76 (58)	A
T_j		- 40 ... + 150	°C
Diode - Rectifier			
V_{RRM}		1600	V
I_F	$T_s = 70\text{ °C}$	58	A
I_{FSM}	$t_p = 10\text{ ms}$, $\sin 180\text{ °}$, $T_j = 25\text{ °C}$	700	A
i^2t	$t_p = 10\text{ ms}$, $\sin 180\text{ °}$, $T_j = 25\text{ °C}$	2400	A ² s
T_j		- 40 ... + 150	°C
I_{tRMS}	per power terminal (20 A / spring)	40	A
T_{stg}	$T_{op} \leq T_{stg}$	- 40 ... + 125	°C
V_{isol}	AC, 1 min.	2500	V

Characteristics		$T_s = 25\text{ °C}$, unless otherwise specified			
Symbol	Conditions	min.	typ.	max.	Units
IGBT - Inverter, Chopper					
V_{CEsat}	$I_C = 35\text{ A}$, $T_j = 25\text{ (125) °C}$		1,7 (2)	2,1 (2,4)	V
$V_{GE(th)}$	$V_{GE} = V_{CE}$, $I_C = 1,5\text{ mA}$	5	5,8	6,5	V
$V_{CE(TO)}$	$T_j = 25\text{ (125) °C}$		1 (0,9)	1,2 (1,1)	V
r_T	$T_j = 25\text{ (125) °C}$		20 (31)	26 (37)	mΩ
C_{ies}	$V_{CE} = 25\text{ V}$, $V_{GE} = 0\text{ V}$, $f = 1\text{ MHz}$		2,4		nF
C_{oes}	$V_{CE} = 25\text{ V}$, $V_{GE} = 0\text{ V}$, $f = 1\text{ MHz}$		0,5		nF
C_{res}	$V_{CE} = 25\text{ V}$, $V_{GE} = 0\text{ V}$, $f = 1\text{ MHz}$		0,3		nF
$R_{th(j-s)}$	per IGBT		0,75		K/W
$t_{d(on)}$	under following conditions		80		ns
t_r	$V_{CC} = 600\text{ V}$, $V_{GE} = \pm 15\text{ V}$		30		ns
$t_{d(off)}$	$I_C = 35\text{ A}$, $T_j = 125\text{ °C}$		410		ns
t_f	$R_{Gon} = R_{Goff} = 15\text{ Ω}$		120		ns
E_{on}	inductive load		4,7		mJ
E_{off}			4		mJ
Diode - Inverter, Chopper					
$V_F = V_{EC}$	$I_F = 35\text{ A}$, $T_j = 25\text{ (125) °C}$		1,8 (1,8)	2,1 (2,2)	V
$V_{(TO)}$	$T_j = 25\text{ (125) °C}$		1 (0,8)	1,1 (0,9)	V
r_T	$T_j = 25\text{ (125) °C}$		23 (31)	29 (37)	mΩ
$R_{th(j-s)}$	per diode		1,5		K/W
I_{RRM}	under following conditions		43		A
Q_{rr}	$I_F = 35\text{ A}$, $V_R = 600\text{ V}$		7		μC
E_{rr}	$V_{GE} = 0\text{ V}$, $T_j = 125\text{ °C}$		3,3		mJ
	$di_F/dt = 1450\text{ A/μs}$				
Diode - Rectifier					
V_F	$I_F = 35\text{ A}$, $T_j = 25\text{ °C}$		1,1		V
$V_{(TO)}$	$T_j = 150\text{ °C}$		0,8		V
r_T	$T_j = 150\text{ °C}$		11		mΩ
$R_{th(j-s)}$	per diode		0,9		K/W
Temperature Sensor					
R_{ts}	3 %, $T_r = 25\text{ (100) °C}$		1000(1670)		Ω
Mechanical Data					
w			65		g
M_s	Mounting torque	2		2,5	Nm

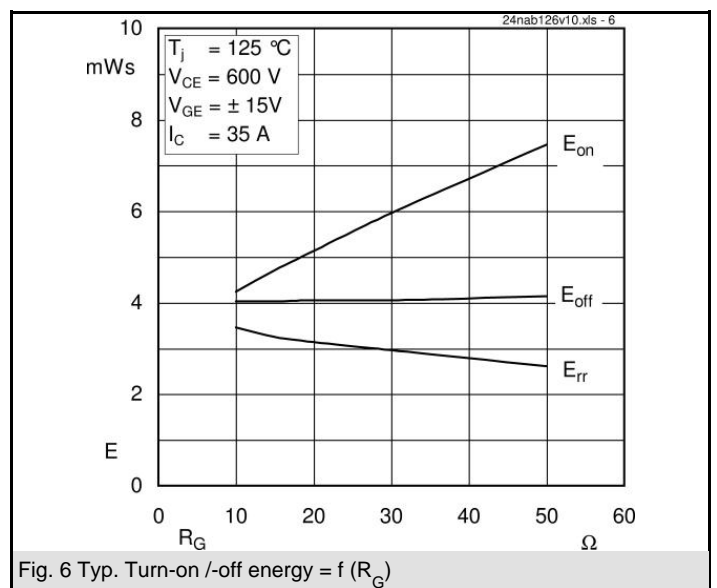
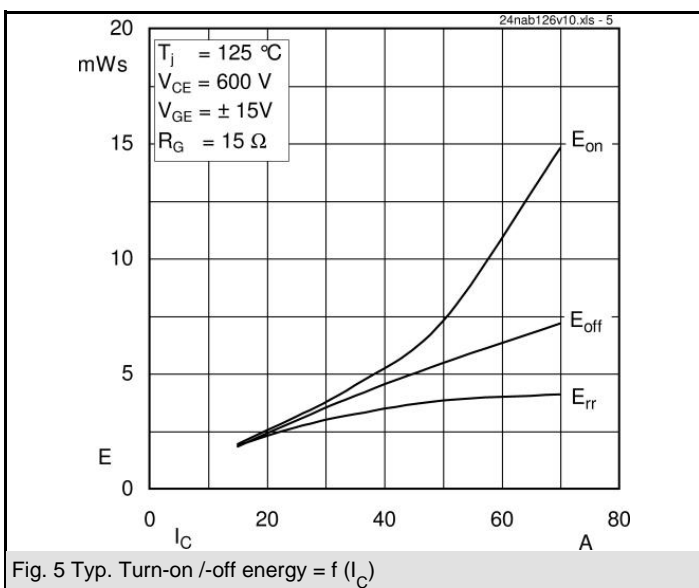
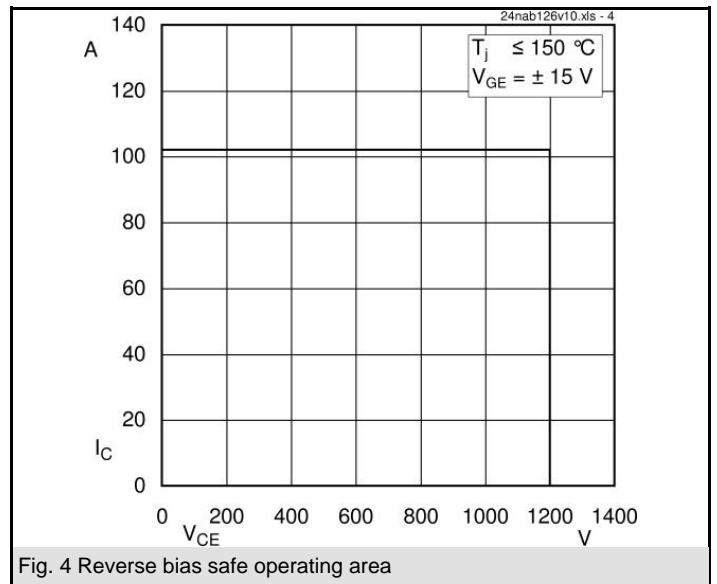
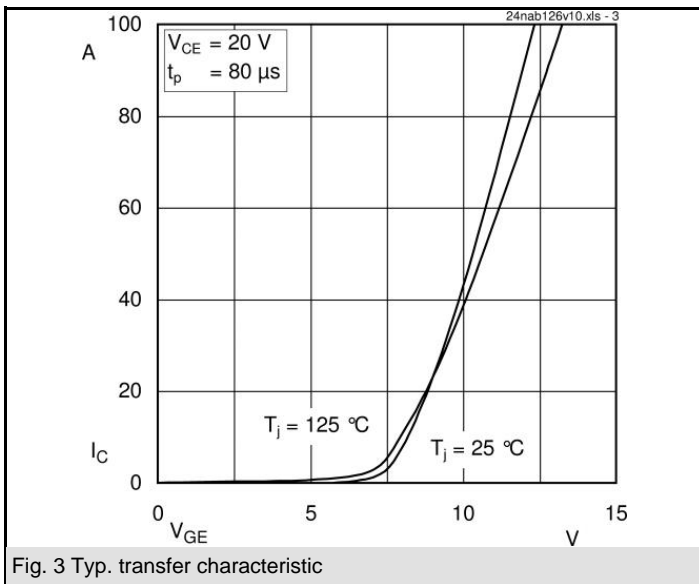
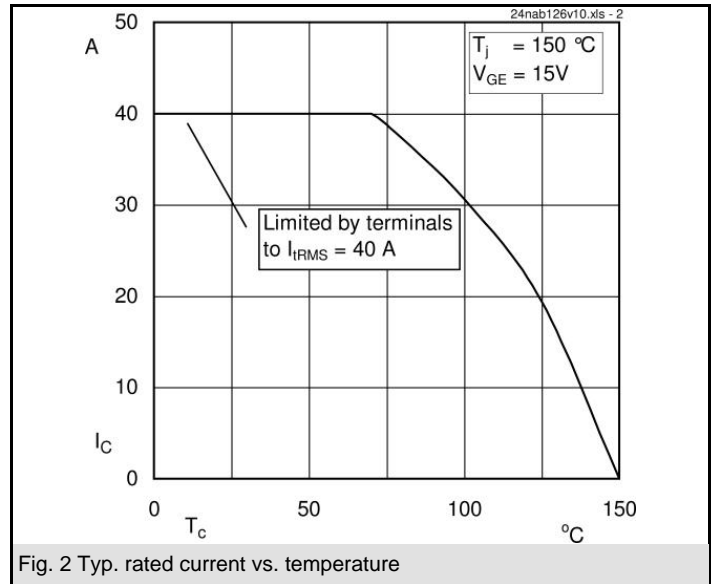
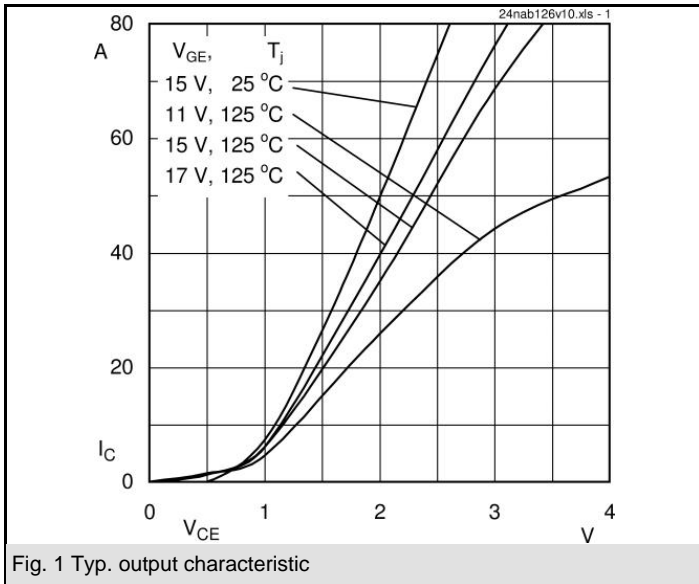

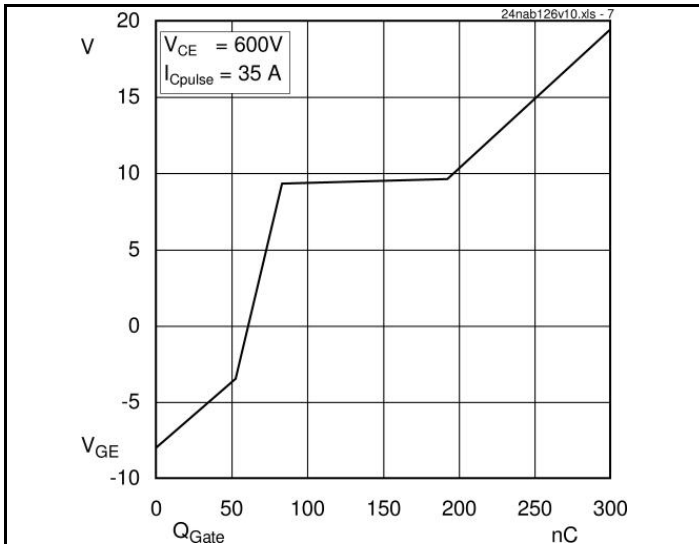

Fig. 7 Typ. gate charge characteristic

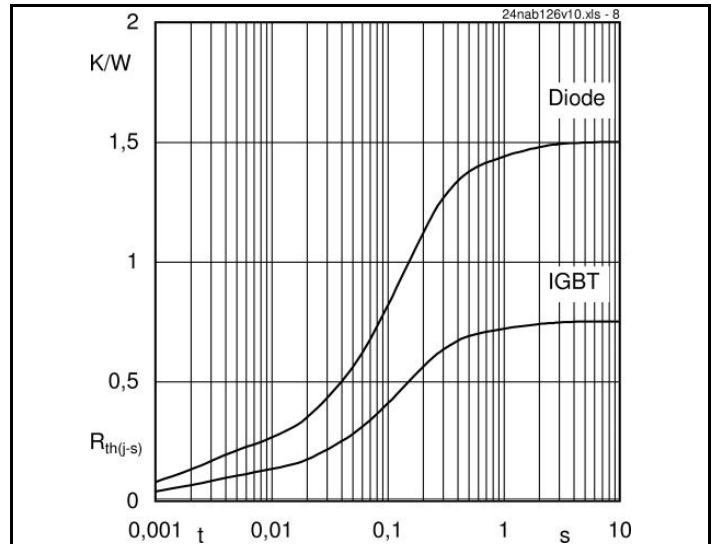

Fig. 8 Typ. thermal impedance

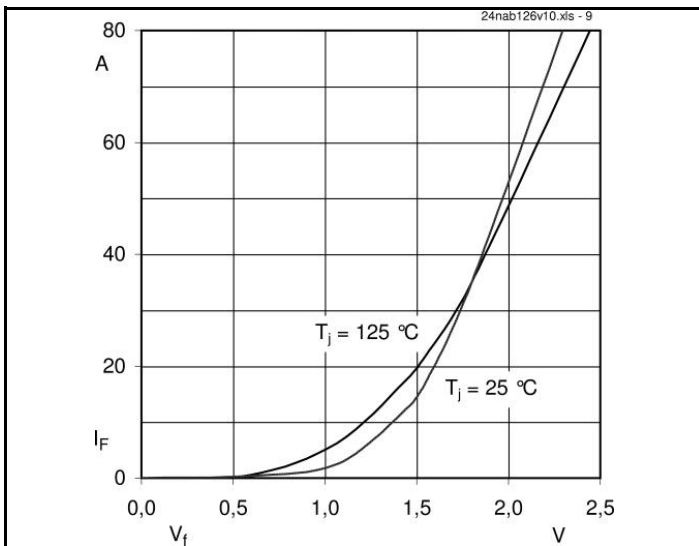

Fig. 9 Typ. freewheeling diode forward characteristic

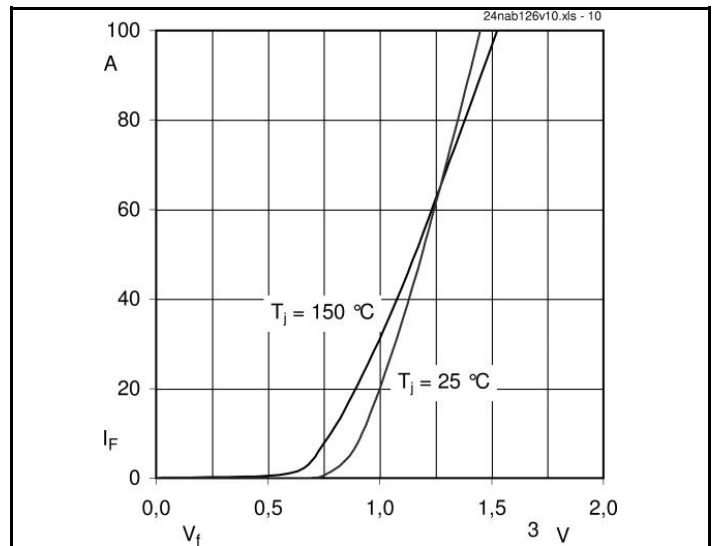
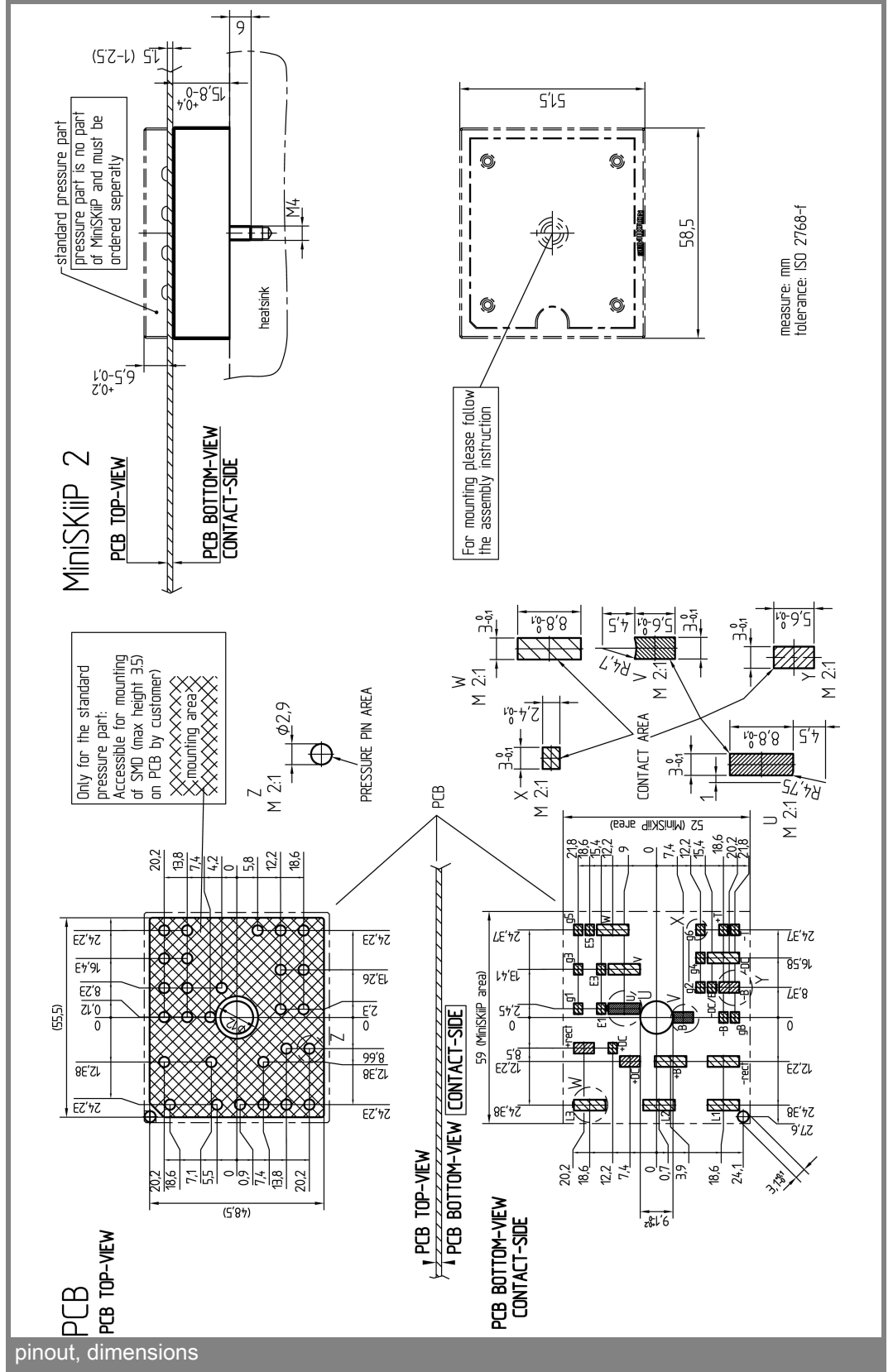
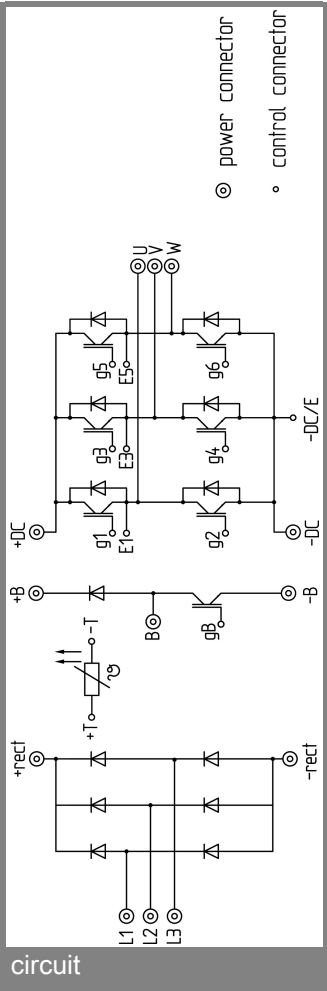

Fig. 10 Typ. input bridge forward characteristic



This is an electrostatic discharge sensitive device (ESDS), international standard IEC 60747-1, Chapter IX.

This technical information specifies semiconductor devices but promises no characteristics. No warranty or guarantee expressed or implied is made regarding delivery, performance or suitability.