

# SKiiP 14AC065V1

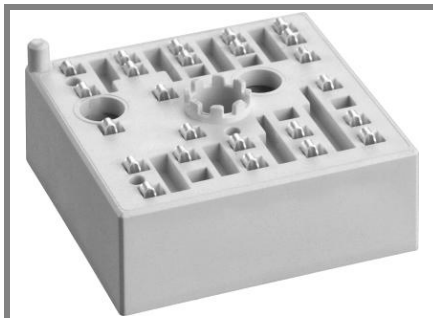

MiniSKiiP® 1

## 3-phase bridge inverter

### SKiiP 14AC065V1

#### Features

- Ultrafast NPT IGBT's
- Robust and soft freewheeling diodes in CAL technology
- Highly reliable spring contacts for electrical connections
- UL recognised file no. E63532

#### Typical Applications

- Inverter up to 6,3 kVA
- Typical motor power 4,0 kW

#### Remarks

- $V_{CEsat}$ ,  $V_F$  = chip level value

Absolute Maximum Ratings		$T_s = 25\text{ °C}$ , unless otherwise specified	
Symbol	Conditions	Values	Units
<b>IGBT - Inverter</b>			
$V_{CES}$	$T_s = 25\text{ (70) °C}$ $t_p \leq 1\text{ ms}$	600	V
$I_C$		29 (22)	A
$I_{CRM}$		40	A
$V_{GES}$		$\pm 20$	V
$T_j$		- 40 ... + 150	°C
<b>Diode - Inverter</b>			
$I_F$	$T_s = 25\text{ (70) °C}$ $t_p \leq 1\text{ ms}$	26 (19)	A
$I_{FRM}$		40	A
$T_j$		- 40 ... + 150	°C
$I_{tRMS}$	per power terminal (20 A / spring)	40	A
$T_{stg}$	$T_{op} \leq T_{stg}$	- 40 ... + 125	°C
$V_{isol}$	AC, 1 min.	2500	V

Characteristics		$T_s = 25\text{ °C}$ , unless otherwise specified			
Symbol	Conditions	min.	typ.	max.	Units
<b>IGBT - Inverter</b>					
$V_{CEsat}$	$I_{Cnom} = 20\text{ A}$ , $T_j = 25\text{ (125) °C}$		2 (2,2)	2,5 (2,7)	V
$V_{GE(th)}$	$V_{GE} = V_{CE}$ , $I_C = 0,5\text{ mA}$	3	4	5	V
$V_{CE(TO)}$	$T_j = 25\text{ (125) °C}$		1,2 (1,1)	1,3 (1,2)	V
$r_T$	$T_j = 25\text{ (125) °C}$		40 (55)	60 (75)	mΩ
$C_{ies}$	$V_{CE} = 25\text{ V}$ , $V_{GE} = 0\text{ V}$ , $f = 1\text{ MHz}$		1,1		nF
$C_{oes}$	$V_{CE} = 25\text{ V}$ , $V_{GE} = 0\text{ V}$ , $f = 1\text{ MHz}$		0,2		nF
$C_{res}$	$V_{CE} = 25\text{ V}$ , $V_{GE} = 0\text{ V}$ , $f = 1\text{ MHz}$		0,1		nF
$R_{th(j-s)}$	per IGBT		1,25		K/W
$t_{d(on)}$	under following conditions		20		ns
$t_r$	$V_{CC} = 300\text{ V}$ , $V_{GE} = \pm 15\text{ V}$		31		ns
$t_{d(off)}$	$I_{Cnom} = 20\text{ A}$ , $T_j = 125\text{ °C}$		170		ns
$t_f$	$R_{Gon} = R_{Goff} = 30\text{ Ω}$		15		ns
$E_{on}$	inductive load		0,7		mJ
$E_{off}$			0,4		mJ
<b>Diode - Inverter</b>					
$V_F = V_{EC}$	$I_{Fnom} = 20\text{ A}$ , $T_j = 25\text{ (125) °C}$		1,6 (1,6)	1,9 (1,9)	V
$V_{(TO)}$	$T_j = 25\text{ (125) °C}$		1 (0,9)	1,1 (1)	V
$r_T$	$T_j = 25\text{ (125) °C}$		30 (33)	40 (47)	mΩ
$R_{th(j-s)}$	per diode		2,2		K/W
$I_{RRM}$	under following conditions		22		A
$Q_{rr}$	$I_{Fnom} = 20\text{ A}$ , $V_R = 300\text{ V}$		1,8		μC
$E_{rr}$	$V_{GE} = 0\text{ V}$ , $T_j = 125\text{ °C}$ $di_F/dt = 1040\text{ A/μs}$		0,4		mJ
<b>Temperature Sensor</b>					
$R_{ts}$	3 %, $T_r = 25\text{ (100) °C}$		1000(1670)		Ω
<b>Mechanical Data</b>					
m			35		g
$M_s$	Mounting torque	2		2,5	Nm

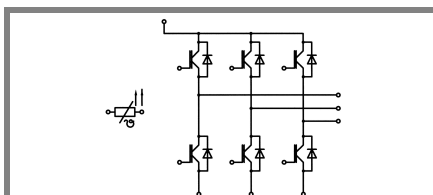

AC

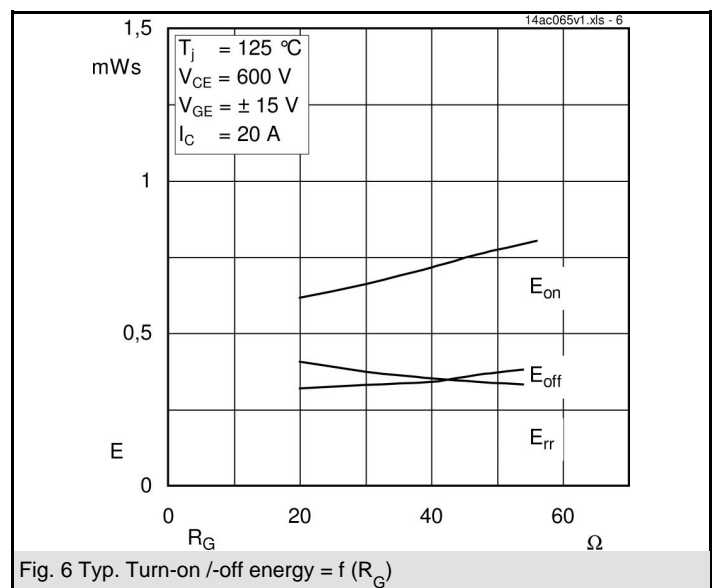
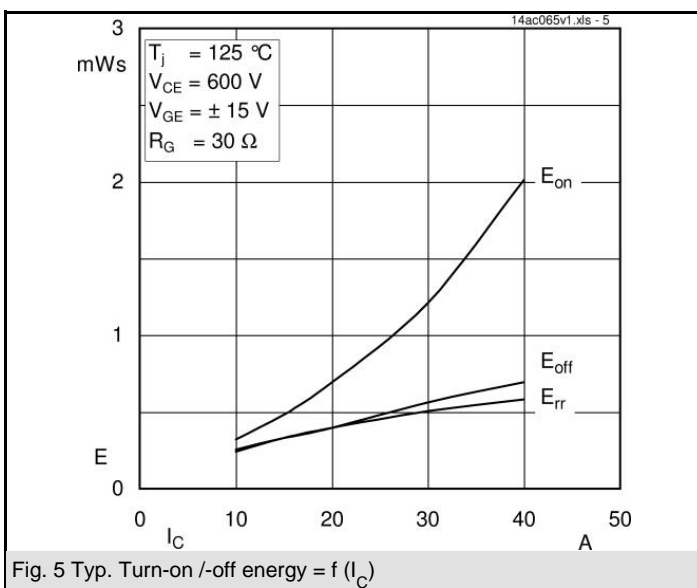
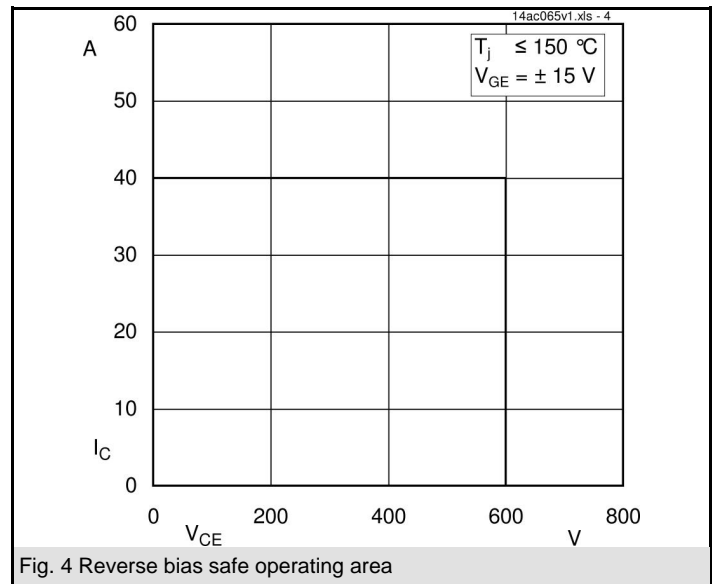
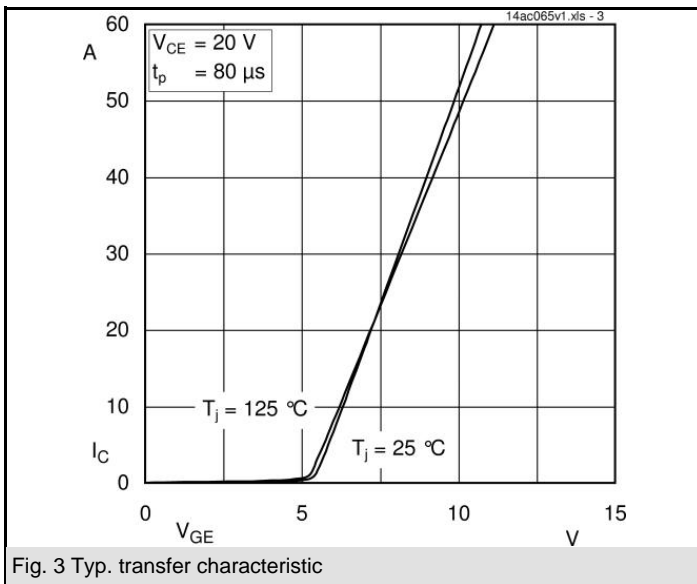
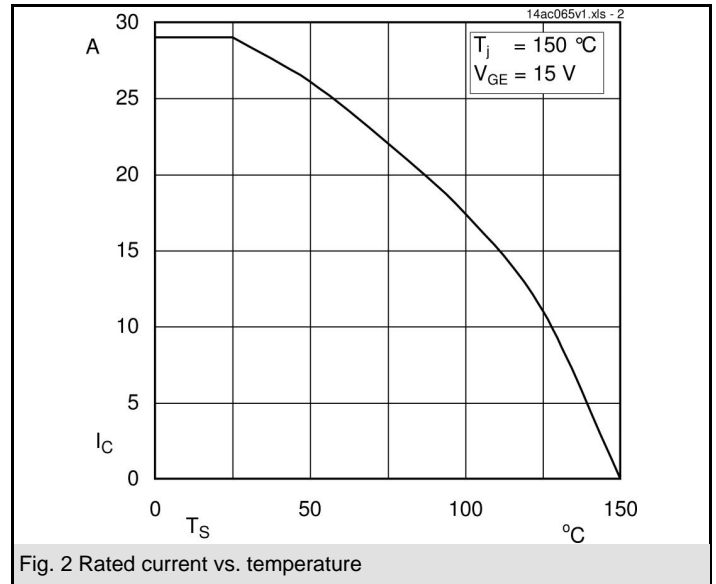
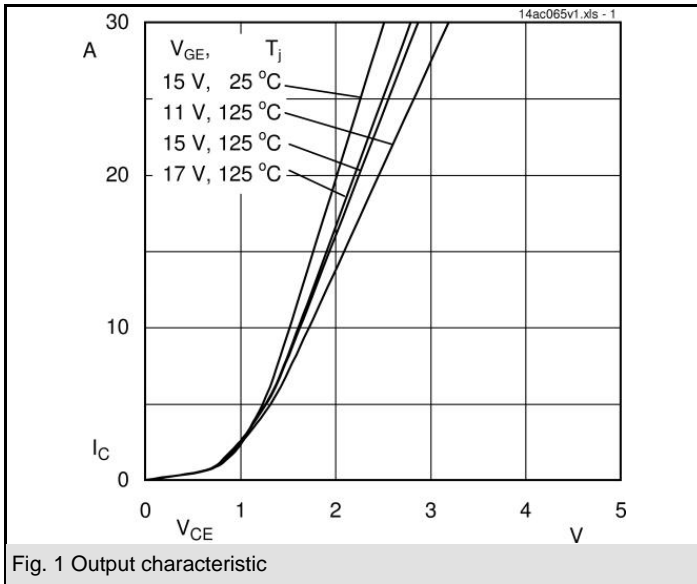

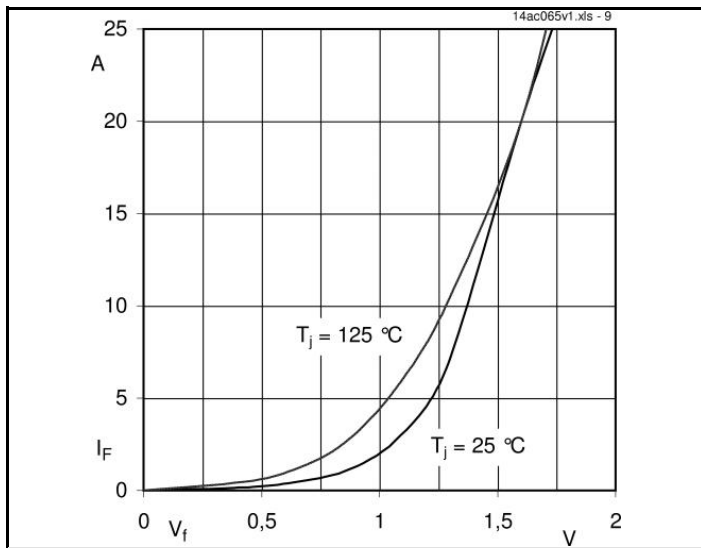
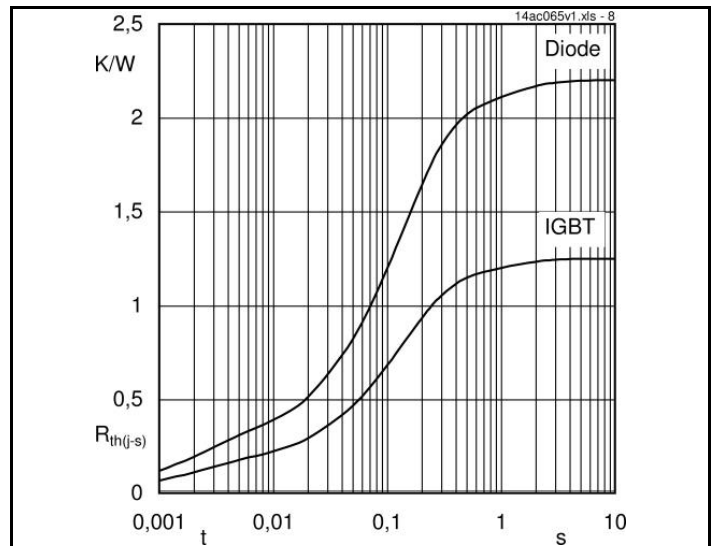
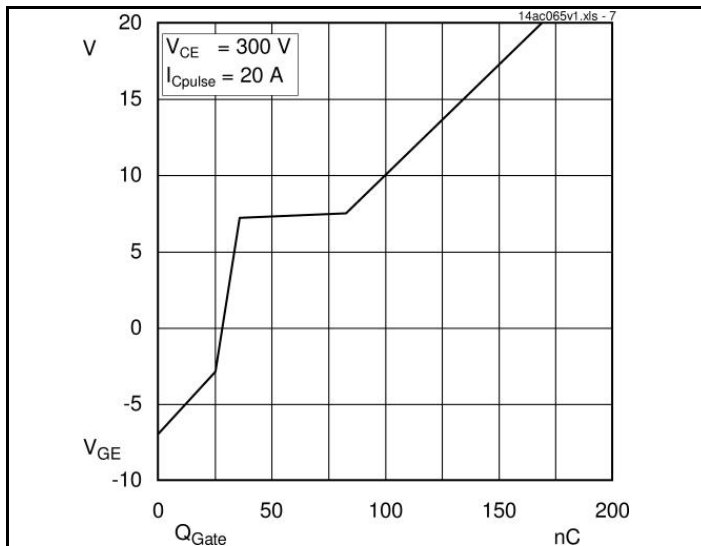

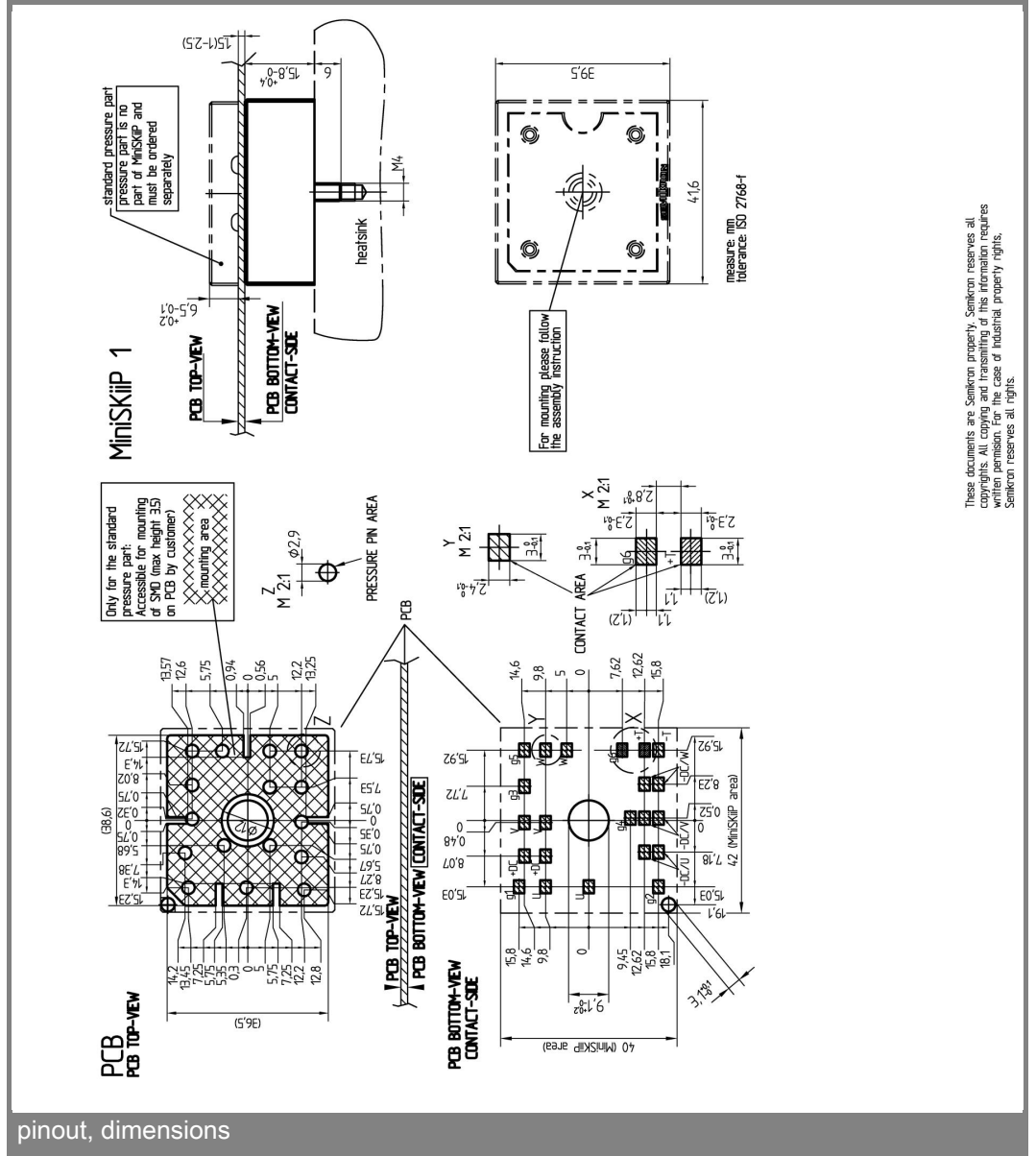
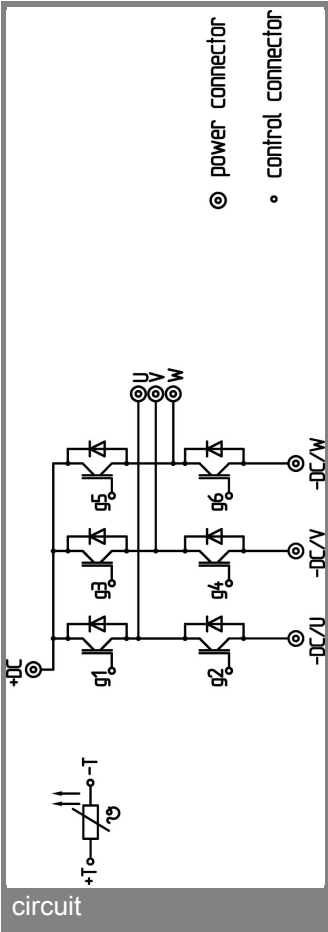

This is an electrostatic discharge sensitive device (ESDS), international standard IEC 60747-1, Chapter IX.

This technical information specifies semiconductor devices but promises no characteristics. No warranty or guarantee expressed or implied is made regarding delivery, performance or suitability.