

Dual transil array for ESD protection

General Description

The LESDAXXXLT1G is a dual monolithic voltage suppressor designed to protect components which are connected to data and transmission lines against ESD. It clamps the voltage just above the logic level supply for positive transients, and to a diode drop below ground for negative transients. It can also work as bidirectional suppressor by connecting only pin1 and 2.

Applications

- Computers
- Printers
- Communication systems

It is particularly recommended for the RS232 I/O port protection where the line interface withstands only with 2kV ESD surges.

Features

- 2 Unidirectional Transil functions
- Low leakage current: $I_R \max < 20 \mu A$ at VBR
- 300W peak pulse power(8/20 μs)
- High ESD protection level: up to 25 kV

Benefits

- High ESD protection level
- up to 25 kV. High integration.
- Suitable for high density boards.

Complies with the following standards

IEC61000-4-2 Level 4

MIL STD 883c - Method 3015-6 Class 3

(Human Body Model)

Absolute Ratings ($T_{amb}=25^{\circ}C$)

Symbol	Parameter	Value	Units
P_{PP}	Peak Pulse Power ($t_p = 8/20\mu s$)	300	W
T_L	Maximum lead temperature for soldering during 10s	260	$^{\circ}C$
T_{stg}	Storage Temperature Range	-55 to +15	$^{\circ}C$
T_{op}	Operating Temperature Range	-40 to +125	$^{\circ}C$
T_j	Maximum junction temperature	150	$^{\circ}C$
V_{PP}	Electrostatic discharge		
	MIL STD 883C -Method 3015-6	25	kv
	IEC61000-4-2 air discharge	16	
IEC61000-4-2 contact discharge	9		

LESDAXXXLT1G

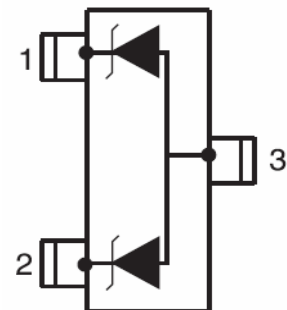

LESDAXXL1G

Electrical Parameter

Symbol	Parameter
V_{RM}	Stand-off voltage
V_{BR}	Breakdown voltage
V_{CL}	Clamping voltage
I_{RM}	Leakage current
I_{PP}	Peak pulse current
αT	Voltage temperature coefficient
V_F	Forward voltage drop
C	Capacitance
R_d	Dynamic resistance

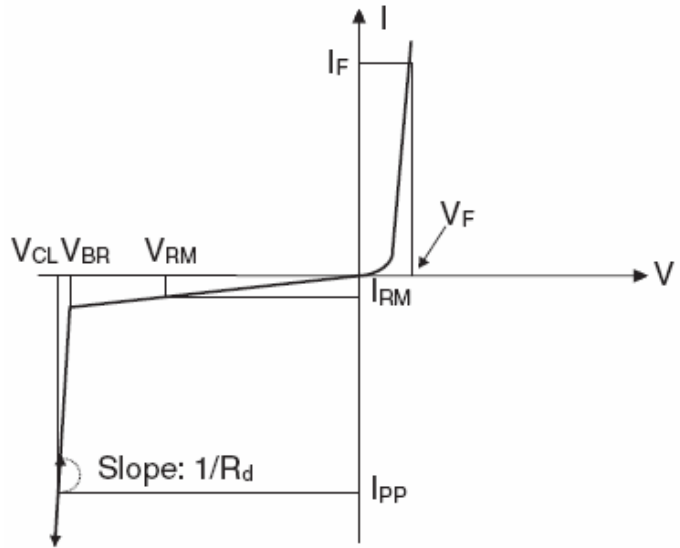

Electrical Characteristics

Part Numbers	V_{BR}		I_R	V_{RM}	I_{RM}	V_F	I_F	R_d	αT	C
	Min.	Max.				Max.		Typ. ⁽¹⁾	Max. ⁽²⁾	Typ. 0v bias
	v	v				v		m Ω	10 ⁻⁴ /°C	pF
LESDA5V3LT1G	5.3	5.9	1	3	2	1.25	200	280	5	220
LESDA6V1LT1G	6.1	7.2	1	5.25	20	1.25	200	350	6	140
LESDA14V2LT1G	14.2	15.8	1	12	5	1.25	200	650	10	90
LESDA25LT1G	25	30	1	24	1	1.2	10	1000	10	50

1. Square pulse $I_{PP}=15A, t_p=2.5\mu s$ 2. $\Delta V_{BR}=\alpha T*(T_{amb}-25^\circ C)*V_{BR}(25^\circ C)$

Typical Characteristics

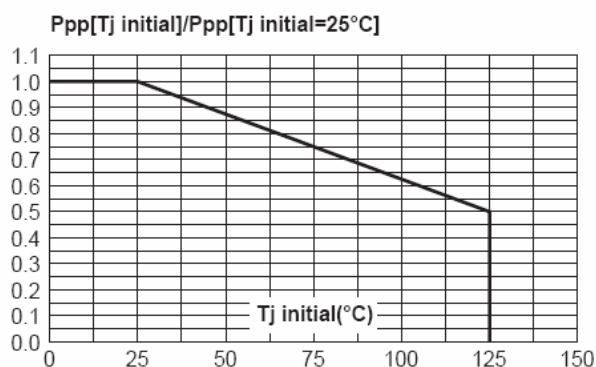

Fig1. Peak power dissipation versus Initial junction temperature

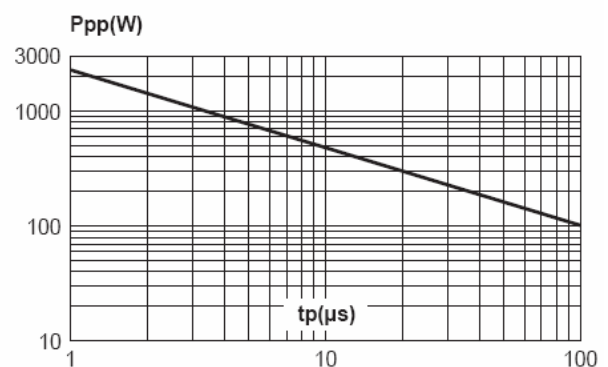

Fig2. Peak pulse power versus exponential pulse duration(T_j initial=25°C)

LESDAXXL1G

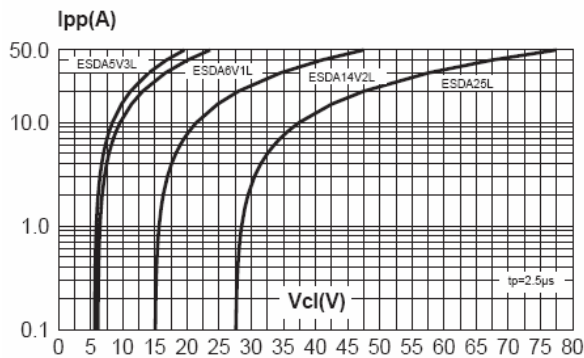

Fig3. Clamping voltage versus peak pulse current (T_j initial=25°C, rectangular Waveform, $t_p=2.5 \mu s$)

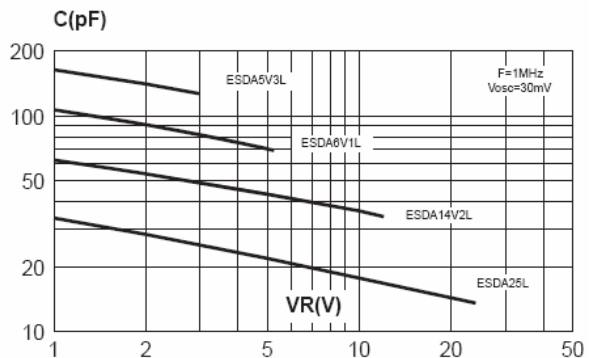

Fig4. Capacitance versus reverse Applied voltage

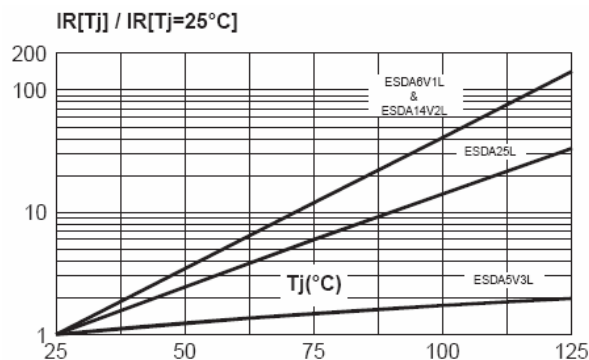

Fig5. Relative variation of leakage current Versus junction temperature

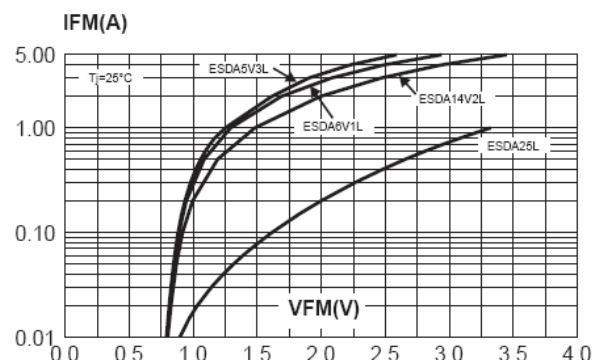

Fig6. Peak forward voltage drop versus peak forward current

Application Note

Electrostatic discharge (ESD) is a major cause of failure in electronic systems. Transient Voltage Suppressors (TVS) are an ideal choice for ESD protection. They are capable of clamping the incoming transient to a low enough level such that damage to the protected semiconductor is prevented.

Surface mount TVS arrays offer the best choice for minimal lead inductance. They serve as parallel protection elements, connected between the signal line to ground. As the transient rises above the operating voltage of the device, the TVS array becomes a low impedance path diverting the transient current to ground. The ESDAxxL array is the ideal board level protection of ESD sensitive semiconductor components.

The tiny SOT23 package allows design flexibility in the design of high density boards where the space saving is at a premium. This enables to shorten the routing and contributes to hardening against ESD.

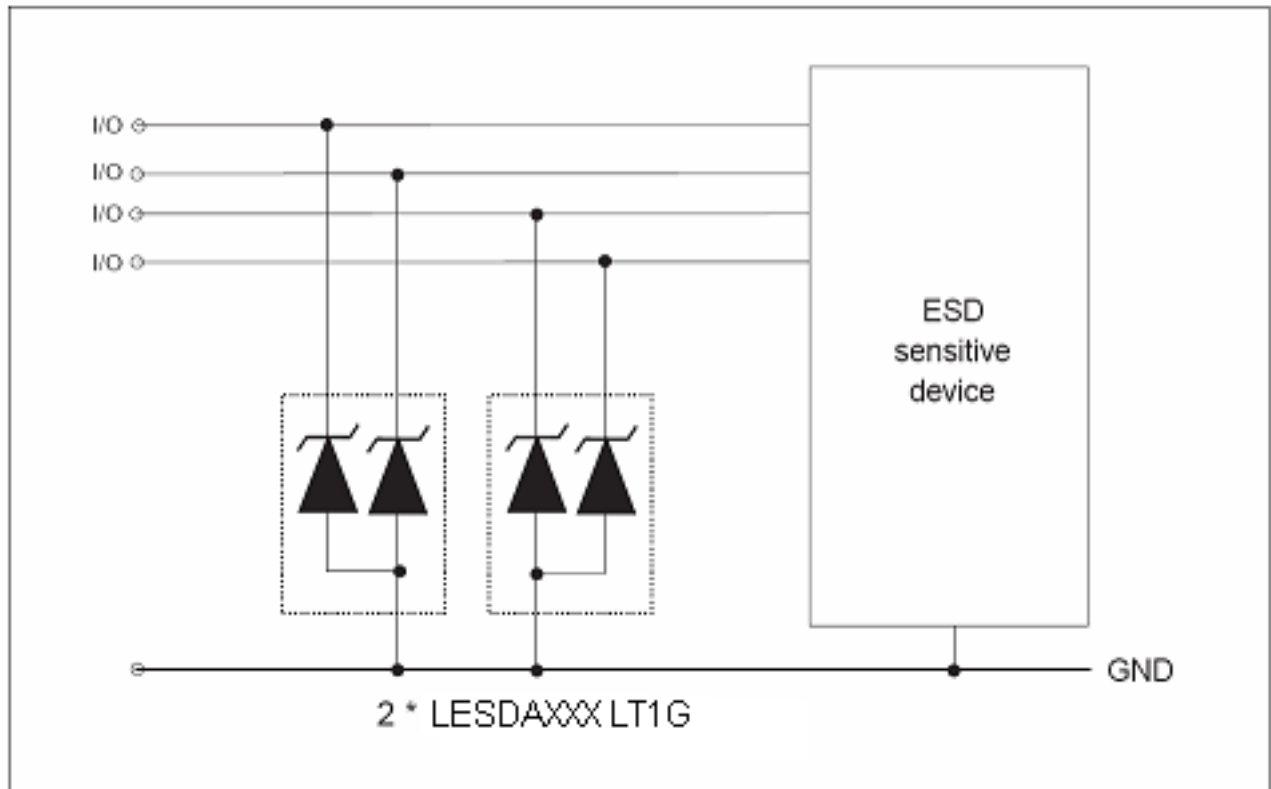
LESDAXXLT1G

LESDAXXL1G

SOT-23

NOTES:

1. DIMENSIONING AND TOLERANCING PER ANSI Y14.5M,1982
2. CONTROLLING DIMENSION: INCH.

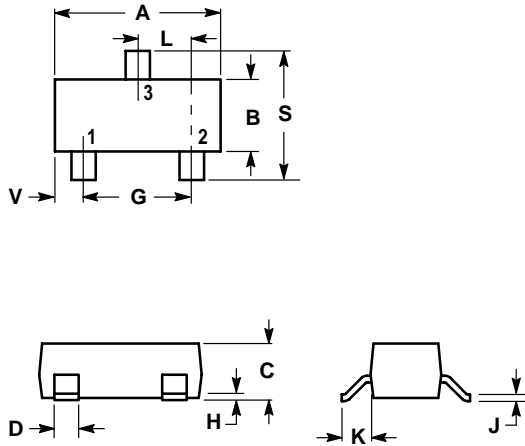

DIM	INCHES		MILLIMETERS	
	MIN	MAX	MIN	MAX
A	0.1102	0.1197	2.80	3.04
B	0.0472	0.0551	1.20	1.40
C	0.0350	0.0440	0.89	1.11
D	0.0150	0.0200	0.37	0.50
G	0.0701	0.0807	1.78	2.04
H	0.0005	0.0040	0.013	0.100
J	0.0034	0.0070	0.085	0.177
K	0.0140	0.0285	0.35	0.69
L	0.0350	0.0401	0.89	1.02
S	0.0830	0.1039	2.10	2.64
V	0.0177	0.0236	0.45	0.60

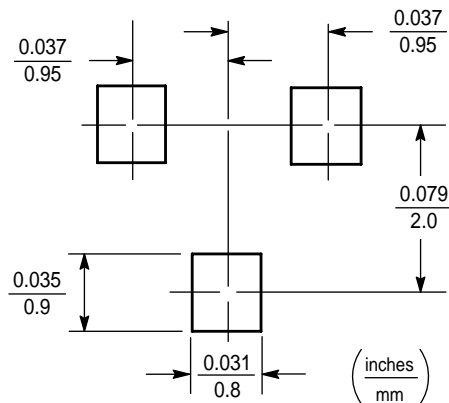

EMBOSSED TAPE AND REEL DATA FOR DISCRETES

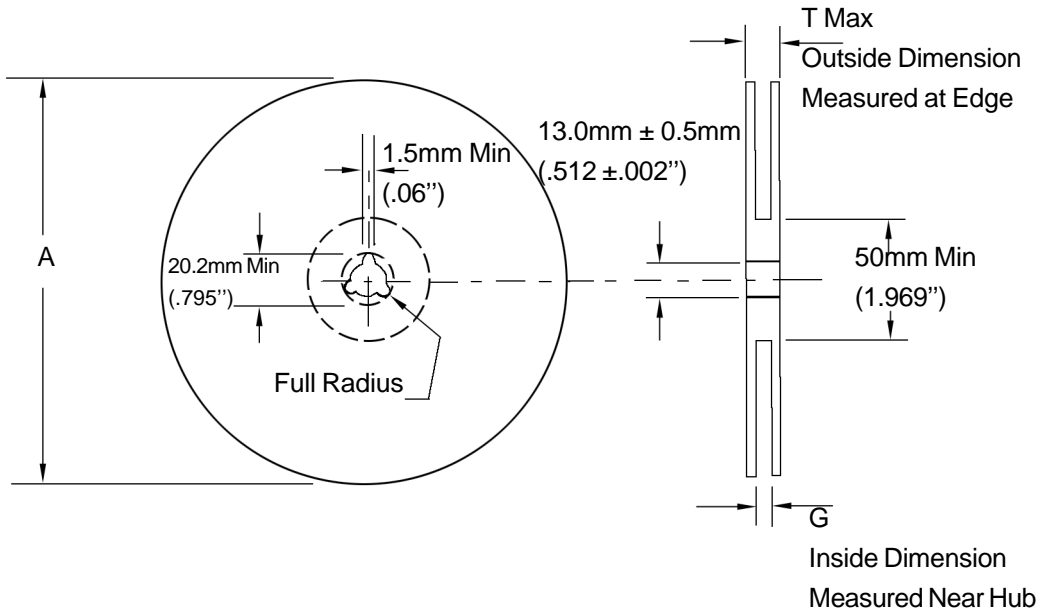

Size	A Max	G	T Max
8 mm	330mm (12.992")	8.4mm+1.5mm, -0.0 (.33"+.059", -0.00)	14.4mm (.56")

Reel Dimensions

Metric Dimensions Govern — English are in parentheses for reference only

Storage Conditions

Temperature: 5 to 40 Deg.C (20 to 30 Deg. C is preferred)

Humidity: 30 to 80 RH (40 to 60 is preferred)

Recommended Period: One year after manufacturing

(This recommended period is for the soldering condition only. The characteristics and reliabilities of the products are not restricted to this limitation)

Shipment Specification

