

CMOS/DMOS Wideband Dual SPDT Analog Switch



CWB2269

FEATURES

- High OFF Isolation
- Low Channel-to-Channel Crosstalk
- Wide Bandwidth
- Broad Analog Signal Range +10V to -10V
- Low ON Resistance..... 20ohms typical
- Low Capacitance
- Data Latches

APPLICATIONS

- RF and Video Switching
- High Speed Data Acquisition
- ATE
- Precision Instrumentation

DESCRIPTION

The CWB2269 is a Precision Dual Single Pole, Double Throw Analog Switch for precision applications in instrumentation, communications and process control where low leakage and high speed switching are required. Designed on the Calogic CMOS/DMOS process this analog switch takes advantage of high speed DMOS switching FETs combined with low voltage CMOS technology in a monolithic structure.

ORDERING INFORMATION

Part	Package	Temperature Range
CWB2269CP	Plastic 16-Pin Dip	0 to +85°C
CWB2269CY	Plastic SO-16 Surface Mount	0 to +85°C
XCWB2269	Sorted Chips in Carriers	0 to +85°C

PIN CONFIGURATION

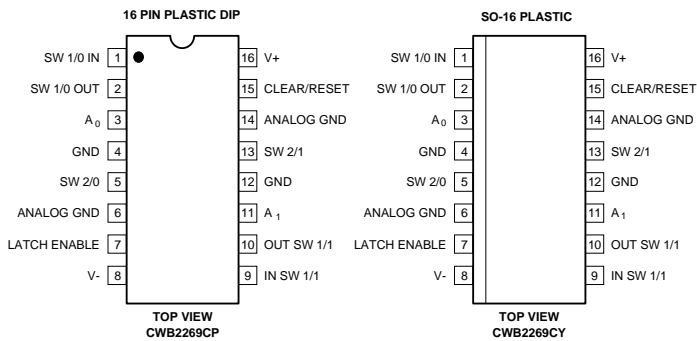

CWB

FUNCTION DIAGRAM

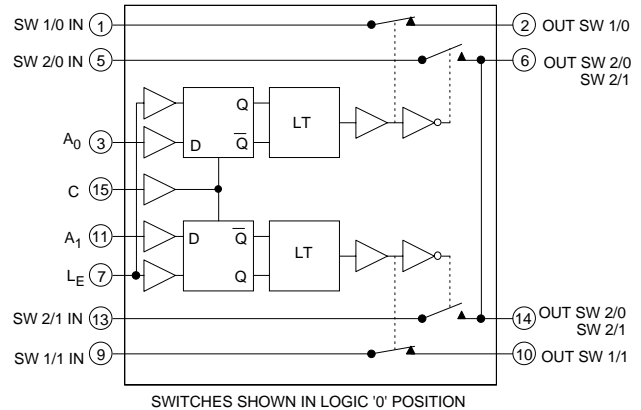

FUNCTION TABLE

INPUT			SWITCH	
A	L _E	C	SW ₁	SW ₂
L	H	L	ON	OFF
H	H	L	OFF	ON
X	X	H	OFF	ON
L	L	L	*(1)	*(2)

X = undefined

*(1) Hold input state one setup before L_E High to Low transaction. If Input state Low then Switch ON. If Input state High then Switch OFF.

*(2) SW₁ = SW₂

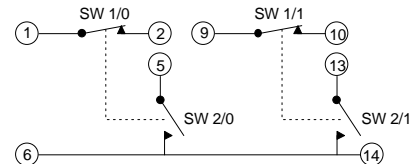

All devices contain diodes to protect inputs against damage due to high static voltages or electric fields; however, it is advised that precautions be taken not to exceed the maximum recommended input voltages. All unused inputs must be connected to an appropriate logic level (either V_{cc} or GND).

ABSOLUTE MAXIMUM RATINGS

V-	Negative Supply Voltage	-20V
V+	Positive Supply Voltage	+20V
V _{IN}	Control Input Voltage Range	V+ +0.3V V- -0.3V
I _L	Continuous Current, any Pin except S or D	20mA
I _S	Continuous Current, S or D	30mA
I _S	Peak Pulsed Current, S or D, 80µsec, 1%, Duty Cycle	100mA
T _J	Junction Temperature Range	-55 to +125°C
T _S	Storage Temperature Range	-55 to +125°C
P _D	Power Dissipation	500mW

RECOMMENDED OPERATING CONDITIONS

V-	Negative Supply Voltage	-8.0 to -15V
V+	Positive Supply Voltage	+8.0 to +15V
V _{IN}	Control Input Voltage Range	0 to +5V
T _{OP}	Operating Temperature	0 to 85°C

ELECTRICAL CHARACTERISTICS (V₋ = -15V, V₊ = +15v unless otherwise noted, T_A = +25°C)

SYMBOL	PARAMETER		MIN	TYP	MAX	UNITS	TEST CONDITIONS		
STATIC									
V _{ANALOG}	Analog Signal Range		-10		+10	V			
r _{DS(ON)}	Channel ON Resistance (Switches 2/0 & 2/1)			29	80	Ω	V _S = -10V, I _S = -1.0mA		
				40	80		V _S = +2.0V, I _S = +1.0mA		
				100	160		V _S = +10V, I _S = +1.0mA		
r _{DS(ON)}	Channel ON Resistance (Switches 1/0 & 1/1)			13	40		V _S = -10V, I _S = -1.0mA		
				20	40		V _S = +2.0V, I _S = +1.0mA		
				50	80		V _S = +10V, I _S = +1.0mA		
V _{IH}	Logic High Level Input Voltage		4.5	3.4		V			
V _{IL}	Logic Low Level Input Voltage				1.0				
I _{IN}	Logic Input Leakage Current			0.01	0.1	µA	V _{IN} = +5.0V		
				0.02	0.1		V _{IN} = +15V		
I _{D(OFF)}	Switch OFF Leakage Current	(Switches 2/0 & 2/1)		0.4	5.0	nA	V _D = +10V, V _S = -10V		
I _{S(OFF)}				4.0	20		V _S = +10V, V _D = -10V		
I _{D(OFF)}		(Switches 1/0 & 1/1)		0.4	5.0		V _S = +10V, V _S = -10V		
I _{S(OFF)}				4.0	20		V _S = +10V, V _D = -10V		
I ₋	Negative Supply Quiescent Current			-0.05	-0.5	µA	V _{IN} = 0 or V ₊		
I ₊	Positive Supply Quiescent Current			.03	0.5				
DYNAMIC									
	Propagation Delay	Data to Switch ON		180	250	nSec			
		Data to Switch OFF		100	200				
		Latch Enable to Sw. ON		180	250				
		Latch Enable to Sw. OFF		140	200				
		Clear to Switch ON		180	250				
		Clear to Switch OFF		90	150				
t _S	Set Up Time		150	120					
t _H	Hold Time		150	90					
P _W	Pulse Width		50	40					
O _{IRR}	OFF Isolation Rejection Ratio (Switches 1/0 & 1/1)		42	45		dB	f = 10MHz	R _L = 50Ω	
			12	15			f = 200MHz		
	Frequency Roll-Off (Bandwidth)			1.0	3.0		f = 200MHz, R _L = 50Ω		
I _L	Insertion Loss (Switches 1/0 & 1/1)			2.0			f = 10MHz	R _L = 50Ω	
				3.0		f = 200MHz			
C _d	Drain-Node Capacitance			0.6		pF	V _D = 0	f = 1MHz,	
C _s	Source-Node Capacitance			6.0			V _S = 0	V _{IN} = 0	

TYPICAL PERFORMANCE CHARACTERISTICS ($T_A = +25^\circ\text{C}$, unless otherwise specified)

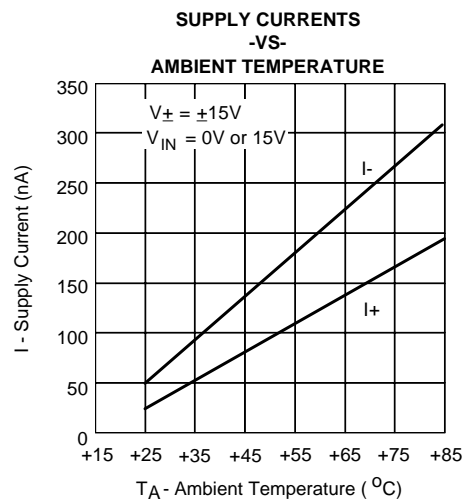
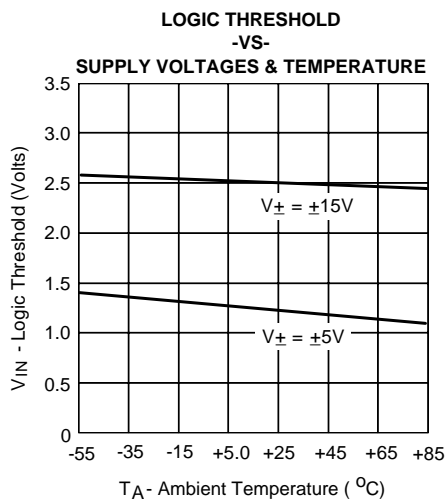
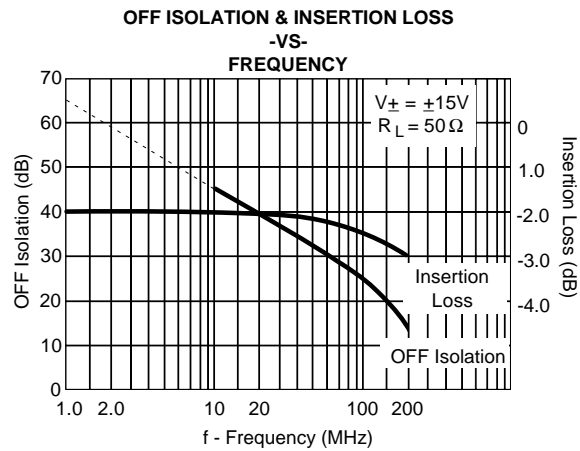
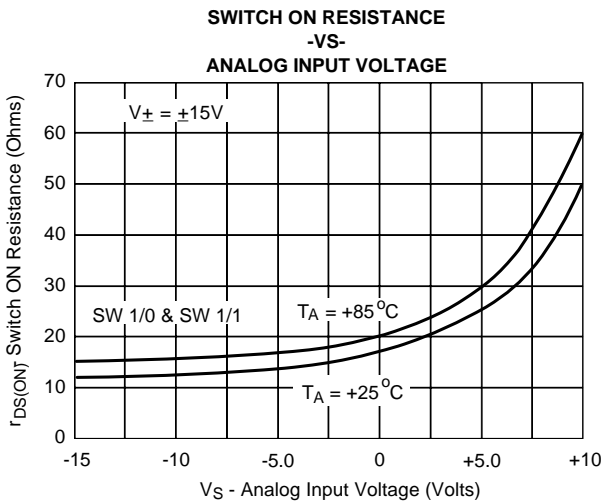
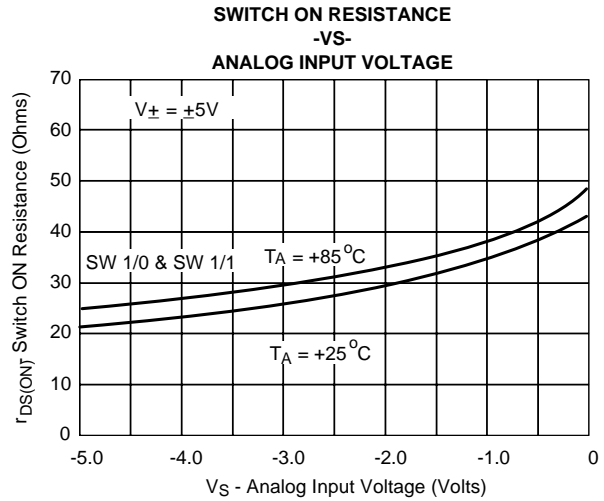
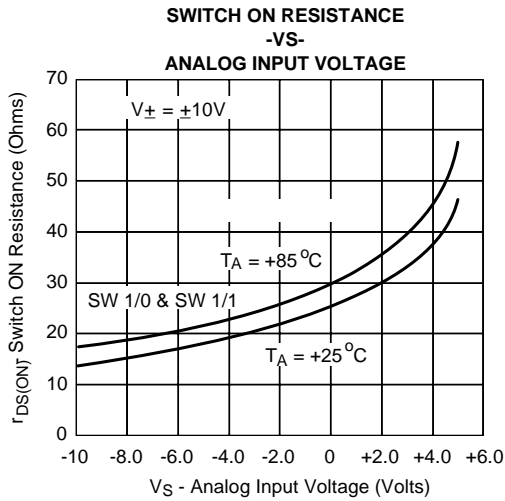

TYPICAL PERFORMANCE CHARACTERISTICS ($T_A = +25^\circ\text{C}$, unless otherwise specified)

