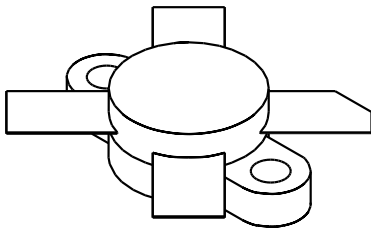

VAM 40

40 Watts, 27 Volts, Class AB
Defcom 100 - 150 MHz

<p>GENERAL DESCRIPTION The VAM 40 is a COMMON EMITTER, specifically designed for collector modulated operation in the VHF AM applications in the 100-150 MHz range.</p>	<p>CASE OUTLINE 55HT, Style 2</p> 
<p>ABSOLUTE MAXIMUM RATINGS</p> <p>Maximum Power Dissipation @ 25°C 50 Watts</p> <p>Maximum Voltage and Current</p> <p>BVces Collector to Emitter Voltage 60 Volts BVebo Emitter to Base Voltage 4.0 Volts Ic Collector Current 5.0 A</p> <p>Maximum Temperatures</p> <p>Storage Temperature - 65 to +150°C Operating Junction Temperature +200°C</p>	

ELECTRICAL CHARACTERISTICS @ 25 °C

SYMBOL	CHARACTERISTICS	TEST CONDITIONS	MIN	TYP	MAX	UNITS
Pout	Power Output	F = 150 MHz	40			Watts
Pin	Power Input	Vcc = 27V, 1 KHz, 50%		3.2	4.0	Watts
Pg	Power Gain		10	11		dB
Pout	Power Output	F = 150 MHz	10			Watts
Pin	Power Input	Vcc = 13.5 Volts			2.0	Watts
Pg	Power Gain			8.0		dB
ηc	Efficiency	F = 150 MHz, Po=10 W		65		%
VSWR	Load Mismatch Tolerance	Vcc = 13.5 Volts			30:1	

BVebo	Emitter to Base Breakdown	Ie = 5 mA	4.0			Volts
BVces	Collector to Emitter Breakdown	Ic = 20 mA	60			Volts
BVceo	Collector to Emitter Breakdown	Ie = 50 mA	32			Volts
Ices	Collector Leakage Current	Vce = 5 Volts			30	mA
Cob	Output Capacitance	Vcb = 28 V, F = 1 MHz			25	pF
hFE	DC - Current Gain	Vce = 5 V, Ic = 500 MA	10		100	
θjc	Thermal Resistance				3.5	°C/W

Issue August 1996

GHz TECHNOLOGY INC. RESERVES THE RIGHT TO MAKE CHANGES WITHOUT FURTHER NOTICE. GHz RECOMMENDS THAT BEFORE THE PRODUCT(S) DESCRIBED HEREIN ARE WRITTEN INTO SPECIFICATIONS, OR USED IN CRITICAL APPLICATIONS, THAT THE PERFORMANCE CHARACTERISTICS BE VERIFIED BY CONTACTING THE FACTORY.



GHZ TECHNOLOGY
RF·MICROWAVE SILICON POWER TRANSISTORS

VAM40

DC SAFE OPERATING AREA

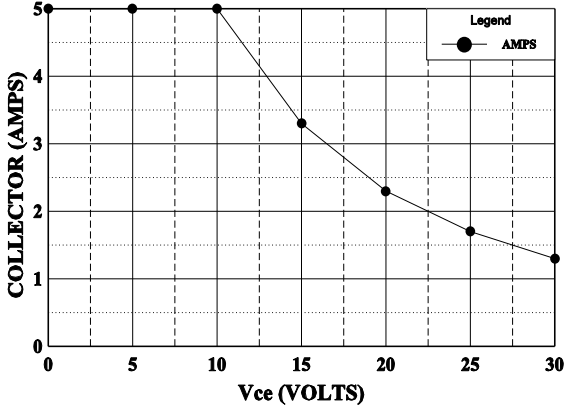

POWER OUTPUT vs POWER INPUT

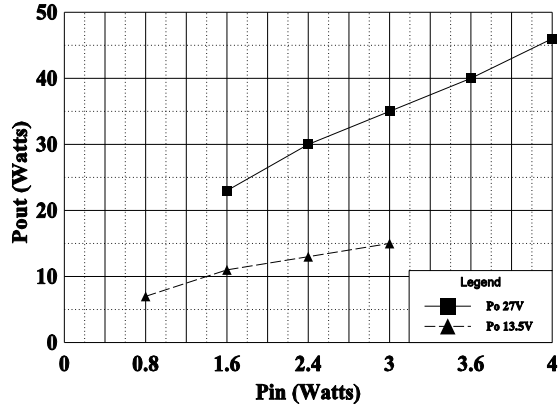

POWER GAIN VS FREQUENCY

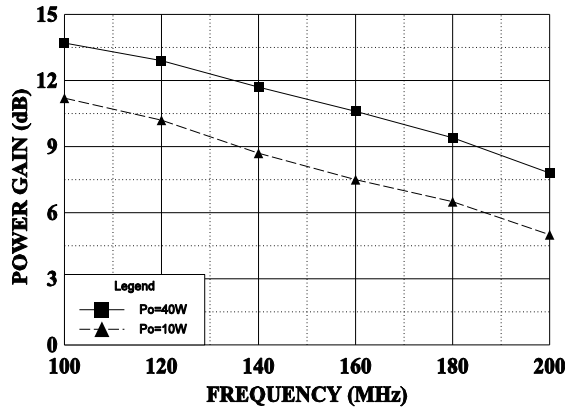

SERIES INPUT IMPEDANCE vs FREQUENCY

Vcc = 27V, Po=40W

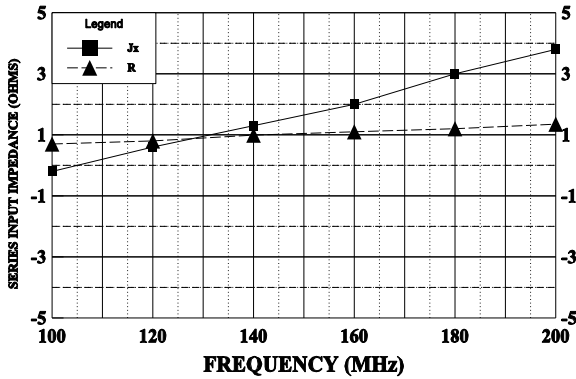

SERIES LOAD IMPEDANCE vs FREQUENCY

Po=40W Vcc=27V

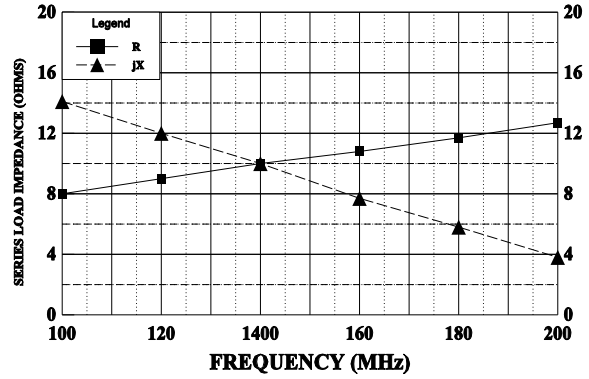

150 MHz TEST AMPLIFIER

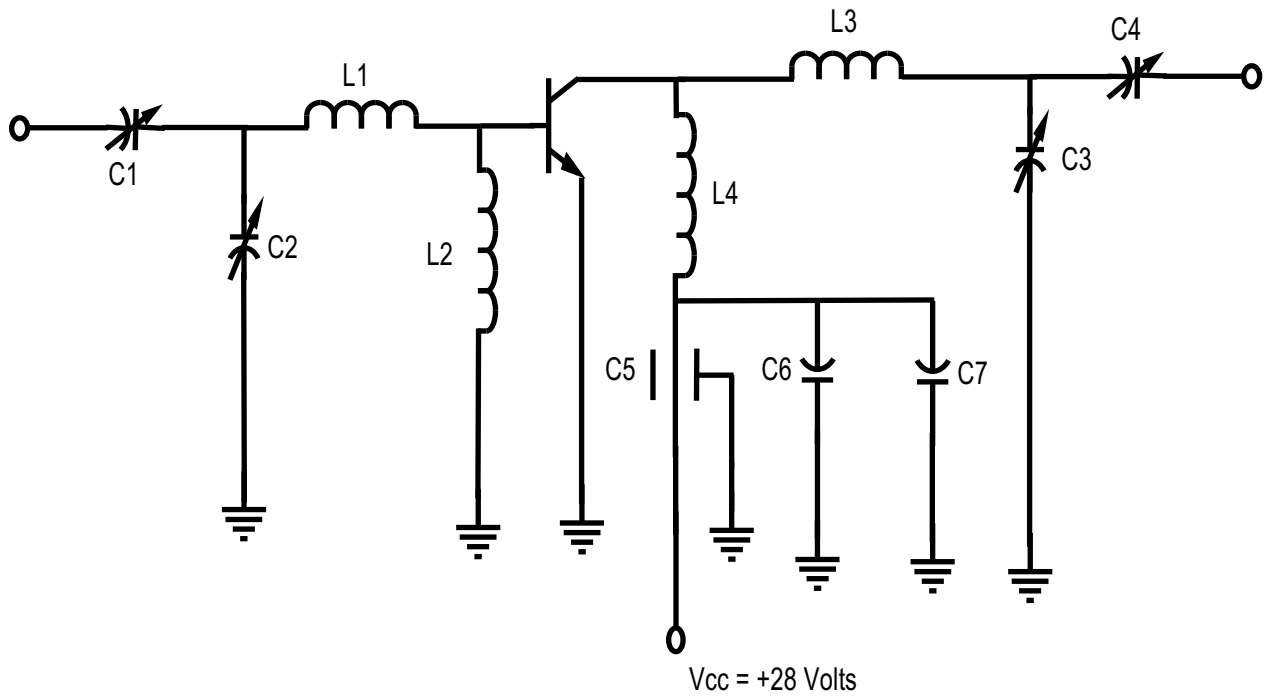

- C1, C2 4-40 pf Elmenco type 403
- C3, C4 2-25 pf Elmenco type 402
- C5001 f
- C61 f
- C7 10 f
- L1 1/2 turn #16, 3/8" I.D.
- L2 1/Outf RFC
- L3 3 turns #16, 3/8" I.D.
- L4 6 turns #16, 3/8" I.D.