

# UG8AT THRU UG8DT

## ULTRAFAST EFFICIENT PLASTIC RECTIFIER

Reverse Voltage - 50 to 200 Volts      Forward Current - 8.0 Amperes

### TO-220AC

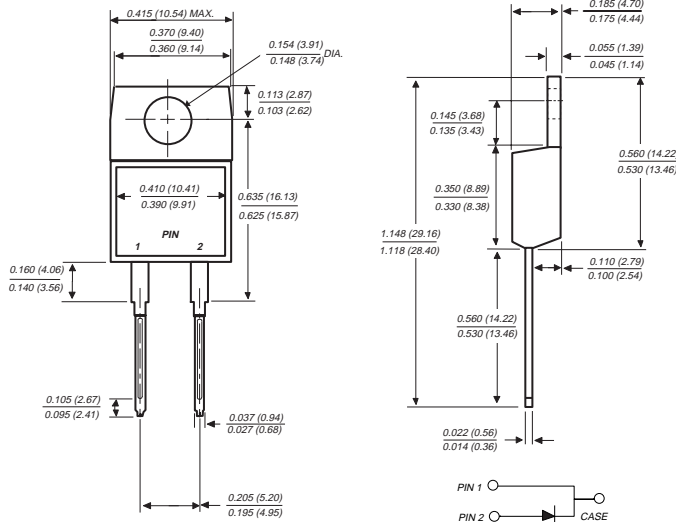

Dimensions in inches and (millimeters)

### FEATURES

- ◆ Plastic package has Underwriters Laboratories Flammability Classification 94V-0
- ◆ Ideally suited for use in very high frequency switching power supplies, inverters and as a free wheeling diode
- ◆ Ultrafast reverse recovery time for high efficiency
- ◆ Soft recovery characteristics
- ◆ Excellent high temperature switching
- ◆ Glass passivated chip junction
- ◆ High temperature soldering guaranteed: 250°C, 0.16" (4.06) from case for 10 seconds

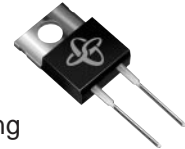

### MECHANICAL DATA

**Case:** JEDEC TO-220AC molded plastic body over passivated chip

**Terminals:** Plated axial leads, solderable per MIL-STD-750, Method 2026

**Polarity:** As marked

**Mounting Position:** Any

**Mounting Torque:** 5in. - lbs. max.

**Weight:** 0.064 ounce, 1.81 grams

### MAXIMUM RATINGS AND CHARACTERISTICS

Ratings at 25°C ambient temperature unless otherwise specified.

	SYMBOLS	UG8AT	UG8BT	UG8CT	UG8DT	UNITS
Maximum repetitive peak reverse voltage	V <sub>RRM</sub>	50	100	150	200	Volts
Maximum RMS voltage	V <sub>RMS</sub>	35	70	105	140	Volts
Maximum DC blocking voltage	V <sub>DC</sub>	50	100	150	200	Volts
Maximum average forward rectified current at T <sub>C</sub> =100°C	I <sub(av)< sub=""></sub(av)<>	8.0				Amps
Peak forward surge current 8.3 ms single half sine-wave superimposed on rated load (JEDEC Method) at T <sub>C</sub> =100°C	I <sub>FSM</sub>	150.0				Amps
Maximum instantaneous forward voltage at 8.0 20A 5.0A, T <sub>J</sub> =150°C	V <sub>F</sub>	1.00 1.20 0.95				Volts
Maximum DC reverse current at rated DC blocking voltage T <sub>A</sub> =25°C T <sub>A</sub> =100°C	I <sub>R</sub>	10.0 300.0				μA
Maximum reverse recovery time (NOTE 1)	t <sub>rr</sub>	20.0				ns
Maximum reverse recovery time (NOTE 2)	t <sub>rr</sub>	30.0 50.0				ns
Maximum recovered stored charge (NOTE 2)	Q <sub>rr</sub>	20.0 45.0				nC
Typical junction capacitance (NOTE 3)	C <sub>J</sub>	45.0				pF
Typical thermal resistance (NOTE 4)	R <sub>θJC</sub>	4.0				°C/W
Operating junction and storage temperature range	T <sub>J</sub> , T <sub>STG</sub>	-55 to+150				°C

#### NOTES:

- (1) Reverse recovery test conditions: I<sub>F</sub>=0.5A, I<sub>R</sub>=1.0A, I<sub>rr</sub>=0.25A
- (2) t<sub>rr</sub> and Q<sub>rr</sub> measured at I<sub>F</sub>=8.0A, V<sub>R</sub>=30V, di/dt=50A/μs, I<sub>rr</sub>=10% I<sub>RM</sub> for measurement of t<sub>rr</sub>
- (3) Measured at 1.0 MHz and applied reverse voltage of 4.0 Volts
- (4) Thermal resistance from junction to case

# RATINGS AND CHARACTERISTIC CURVES UG8AT THRU UG8DT

**FIG. 1 - FORWARD CURRENT DERATING CURVE**

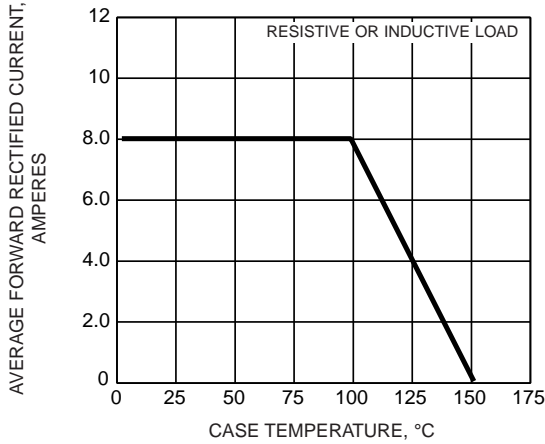

**FIG. 2 - MAXIMUM NON-REPETITIVE PEAK FORWARD SURGE CURRENT**

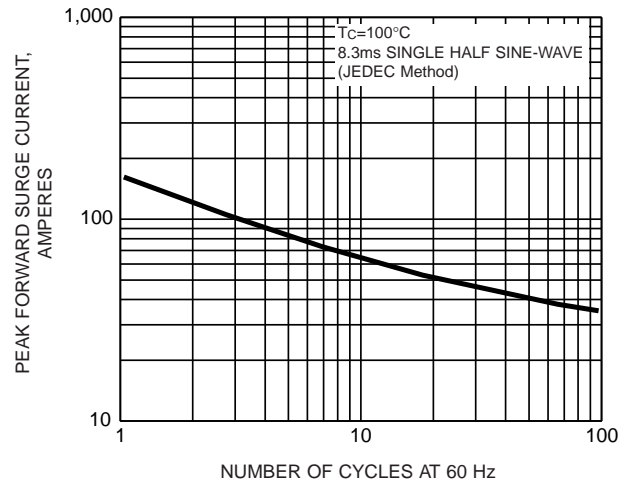

**FIG. 3 - TYPICAL INSTANTANEOUS FORWARD CHARACTERISTICS**

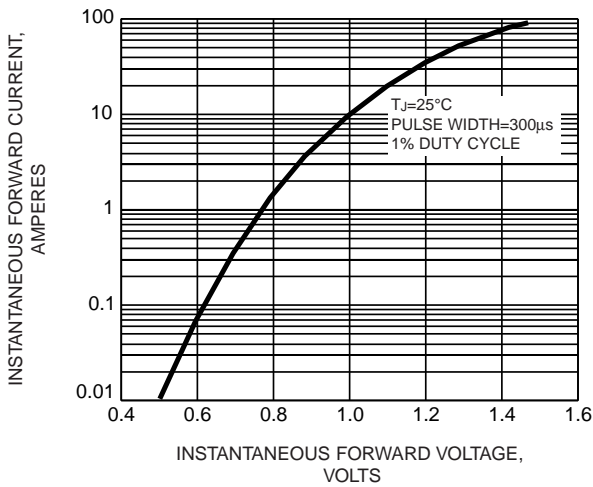

**FIG. 4 - TYPICAL REVERSE CHARACTERISTICS**

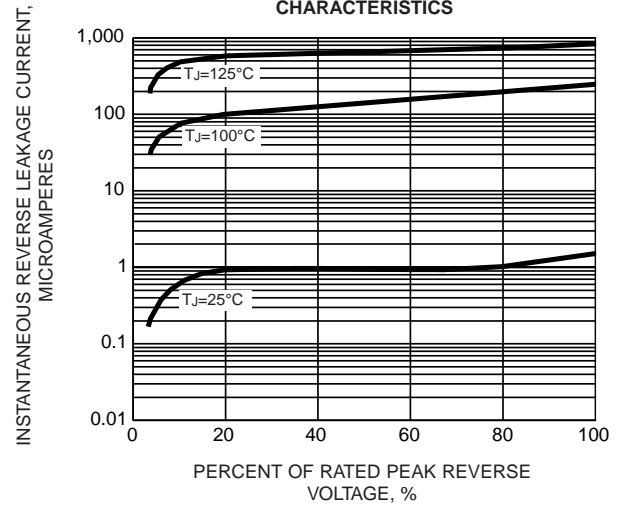

**FIG. 5 - REVERSE SWITCHING CHARACTERISTICS**

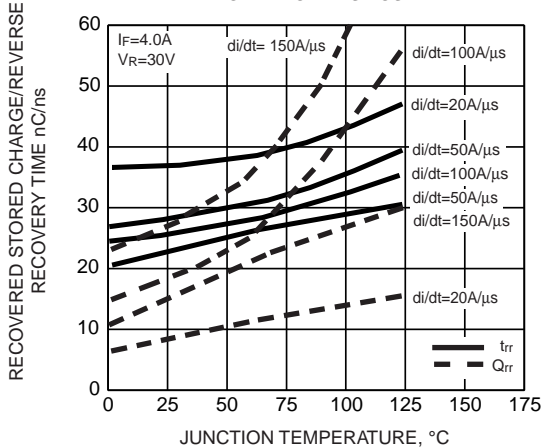

**FIG. 6 - TYPICAL JUNCTION CAPACITANCE**

