



TS1871-TS1872-TS1874

1.8V input/output rail-to-rail
Low power operational amplifiers

Features

- Operating range from $V_{CC} = 1.8V$ to $6V$
- Rail-to-rail input and output
- Extended V_{icm} ($V_{DD} - 0.2V$ to $V_{CC} + 0.2V$)
- Low supply current ($400\mu A$)
- Gain bandwidth product ($1.6MHz$)
- High unity gain stability
- ESD tolerance ($2kV$)
- Latch-up immunity
- Available in SOT23-5 micro package

Applications

- Battery-powered applications (toys)
- Portable communication devices (cell phones)
- Audio driver (headphone drivers)
- Laptop/notebook computers

Description

The TS187x (single, dual & quad) is an operational amplifier family able to operate with voltages as low as $1.8V$ and features both input and output rail-to-rail.

The common mode input voltage extends $200mV$ beyond the supply voltages at $25^{\circ}C$ while the output voltage swing is within $100mV$ of each rail with 600Ω load resistor. This device consumes typically $400\mu A$ per channel while offering $1.6MHz$ of gain-bandwidth product. The amplifier provides high output drive capability typically at $65mA$ load.

These features make the TS187x family ideal for sensor interface, battery-supplied and portable applications.

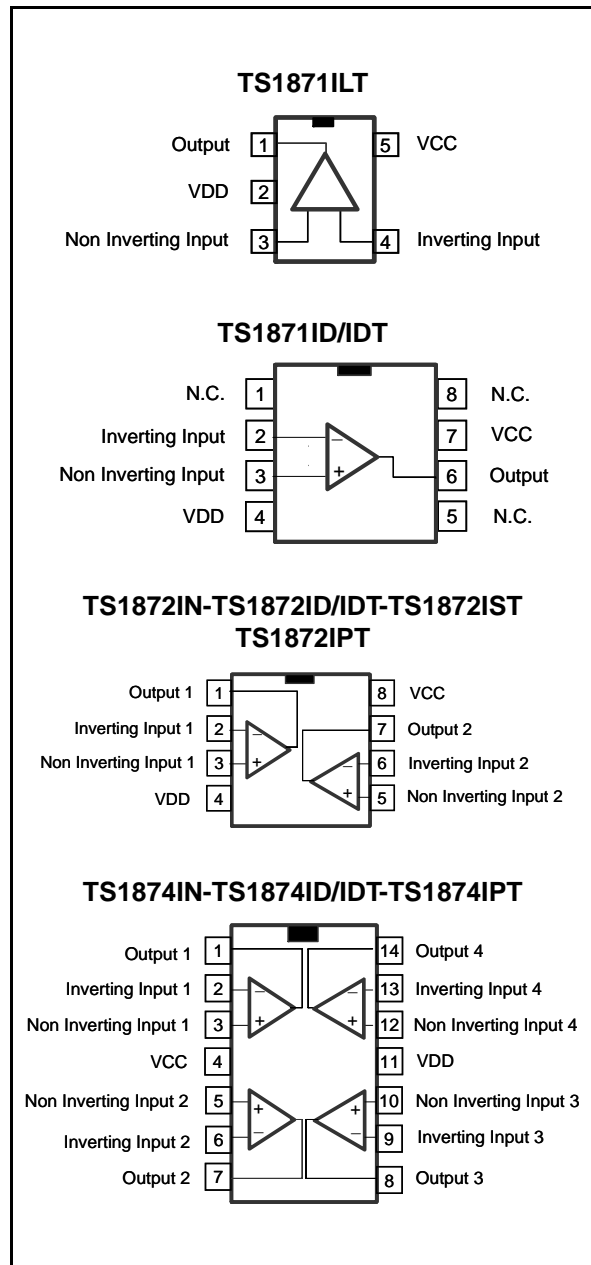

Contents

- 1 Absolute maximum ratings and operating conditions 3**
- 2 Electrical characteristics 5**
- 3 Package mechanical data 16**
 - 3.1 DIP8 package 17
 - 3.2 SO-8 package 18
 - 3.3 TSSOP8 package 19
 - 3.4 MiniSO-8 package 20
 - 3.5 DIP14 package 21
 - 3.6 SO-14 package 22
 - 3.7 TSSOP14 package 23
 - 3.8 SOT23-5 package 24
- 4 Ordering information 25**
- 5 Revision history 26**

1 Absolute maximum ratings and operating conditions

Table 1. Absolute maximum ratings

Symbol	Parameter	Value	Unit
V_{CC}	Supply voltage ⁽¹⁾	7	V
V_{id}	Differential input voltage ⁽²⁾	± 1	V
V_i	Input voltage	$V_{DD} - 0.3$ to $V_{CC} + 0.3$	V
T_{stg}	Storage temperature	-65 to +150	°C
T_j	Maximum junction temperature	150	°C
R_{thja}	Thermal resistance junction to ambient ⁽³⁾		°C/W
	SOT23-5	250	
	DIP8	85	
	DIP14	66	
	miniSO-8	190	
	SO-8	125	
	SO-14	103	
	TSSOP8 TSSOP14	120 100	
R_{thjc}	Thermal resistance junction to case		°C/W
	SOT23-5	81	
	DIP8	41	
	DIP14	33	
	miniSO-8	39	
	SO-8	40	
	SO-14	31	
	TSSOP8 TSSOP14	37 32	
ESD	HBM: human body model ⁽⁴⁾	2	kV
	MM: machine model ⁽⁵⁾	200	V
	CDM: charged device model ⁽⁶⁾	1.5	kV
	Latch-up immunity	200	mA
	Lead temperature (soldering, 10 sec)	250	°C
	Output short-circuit duration	see note ⁽⁷⁾	

- All voltage values, except differential voltage are with respect to network terminal.
- Differential voltages are the non-inverting input terminal with respect to the inverting input terminal. If $V_{id} > \pm 1V$, the maximum input current must not exceed $\pm 1mA$. When $V_{id} > \pm 1V$, add an input series resistor to limit input current.
- Short-circuits can cause excessive heating. Destructive dissipation can result from simultaneous short-circuits on all amplifiers.
- Human body model: A 100pF capacitor is charged to the specified voltage, then discharged through a 1.5k Ω resistor between two pins of the device. This is done for all couples of connected pin combinations while the other pins are floating.
- Machine model: A 200pF capacitor is charged to the specified voltage, then discharged directly between two pins of the device with no external series resistor (internal resistor < 5 Ω). This is done for all couples of connected pin combinations while the other pins are floating.
- Charged device model: all pins and the package are charged together to the specified voltage and then discharged directly to the ground through only one pin. This is done for all pins.
- Short-circuits from the output to V_{CC} can cause excessive heating. The maximum output current is approximately 80mA, independent of the magnitude of V_{CC} . Destructive dissipation can result from simultaneous short-circuits on all amplifiers.

Table 2. Operating conditions

Symbol	Parameter	Value	Unit
V_{CC}	Supply voltage	1.8 to 6	V
V_{icm}	Common mode input voltage range $T_{op} = 25^{\circ}\text{C}$, $1.8 \leq V_{CC} \leq 6\text{V}$ $T_{min} < T_{op} < T_{max}$, $1.8 \leq V_{CC} \leq 6\text{V}$	$V_{DD} - 0.2$ to $V_{CC} + 0.2$ V_{DD} to V_{CC}	V
T_{oper}	Operating free air temperature range	-40 to + 125	$^{\circ}\text{C}$

2 Electrical characteristics

Table 3. Electrical characteristics at $V_{CC} = +1.8V$ with $V_{DD} = 0V$, C_L & R_L connected to $V_{CC}/2$, and $T_{amb} = 25^\circ C$ (unless otherwise specified)⁽¹⁾

Symbol	Parameter	Conditions	Min.	Typ.	Max.	Unit
V_{io}	Input offset voltage	$V_{icm} = V_{out} = V_{CC}/2$ TS1871A/2A/4A $T_{min} \leq T_{amb} \leq T_{max}$ TS1871/2/4 $T_{min} \leq T_{amb} \leq T_{max}$		0.1	1 1.5 3 6	mV
ΔV_{io}	Input offset voltage drift			2		$\mu V/^\circ C$
I_{io}	Input offset current	$V_{icm} = V_{out} = V_{CC}/2$ ⁽²⁾ $T_{min} \leq T_{amb} \leq T_{max}$		3	30 60	nA
I_{ib}	Input bias current	$V_{icm} = V_{out} = V_{CC}/2$ ⁽¹⁾ $T_{min} \leq T_{amb} \leq T_{max}$		40	125 150	nA
CMR	Common mode rejection ratio $20 \log (\Delta V_{ic}/\Delta V_{io})$	$0 \leq V_{icm} \leq V_{CC}$, $V_{out} = V_{CC}/2$ $T_{min} \leq T_{amb} \leq T_{max}$	55 52	77		dB
A_{vd}	Large signal voltage gain	$V_{out} = 0.5V$ to $1.3V$ $R_L = 2k\Omega$ $R_L = 600\Omega$	77 70	92 85		dB
V_{OH}	High level output voltage	$V_{id} = 100mV$ $R_L = 2k\Omega$ $R_L = 600\Omega$ $T_{min} \leq T_{amb} \leq T_{max}$, $R_L = 2k\Omega$ $T_{min} \leq T_{amb} \leq T_{max}$, $R_L = 600\Omega$	1.65 1.62 1.65 1.62	1.77 1.74		V
V_{OL}	Low level output voltage	$V_{id} = -100mV$ $R_L = 2k\Omega$ $R_L = 600\Omega$ $T_{min} \leq T_{amb} \leq T_{max}$, $R_L = 2k\Omega$ $T_{min} \leq T_{amb} \leq T_{max}$, $R_L = 600\Omega$		88 115	100 150 100 150	mV
I_o	Output source current	$V_{ID} = 100mV$, $V_O = V_{DD}$	20	65		mA
	Output sink current	$V_{ID} = -100mV$, $V_O = V_{CC}$	20	65		
I_{CC}	Supply current (per amplifier)	$V_{out} = V_{CC}/2$ $A_{VCL} = 1$, no load $T_{min} \leq T_{amb} \leq T_{max}$		400	560 600	μA
GBP	Gain bandwidth product	$R_L = 10k\Omega$, $C_L = 100pF$, $f = 100kHz$	0.9	1.6		MHz
SR	Slew rate	$R_L = 10k\Omega$, $C_L = 100pF$, $A_V = 1$	0.38	0.54		$V/\mu s$
ϕ_m	Phase margin	$C_L = 100pF$		53		Degrees
en	Input voltage noise	$f = 1kHz$		27		nV/\sqrt{Hz}
THD	Total harmonic distortion			0.01		%

1. All parameter limits at temperatures different from 25°C are guaranteed by correlation.
 2. Maximum values include unavoidable inaccuracies of the industrial tests.

**Table 4. Electrical characteristics at $V_{CC} = +3V$
with $V_{DD} = 0V$, C_L & R_L connected to $V_{CC}/2$, and $T_{amb} = 25^\circ C$ (unless otherwise specified)⁽¹⁾**

Symbol	Parameter	Conditions	Min.	Typ.	Max.	Unit
V_{io}	Input offset voltage	$V_{icm} = V_{out} = V_{CC}/2$ TS1871A/2A/4A $T_{min} \leq T_{amb} \leq T_{max}$ TS1871/2/4 $T_{min} \leq T_{amb} \leq T_{max}$		0.1	1 1.5 3 6	mV
ΔV_{io}	Input offset voltage drift			2		$\mu V/^\circ C$
I_{io}	Input offset current	$V_{icm} = V_{out} = V_{CC}/2$ ⁽²⁾ $T_{min} \leq T_{amb} \leq T_{max}$		3	30 60	nA
I_{ib}	Input bias current	$V_{icm} = V_{out} = V_{CC}/2$ ⁽¹⁾ $T_{min} \leq T_{amb} \leq T_{max}$		4	125 150	nA
CMR	Common mode rejection ratio $20 \log (\Delta V_{ic}/\Delta V_{io})$	$0 \leq V_{icm} \leq V_{CC}$, $V_{out} = V_{CC}/2$ $T_{min} \leq T_{amb} \leq T_{max}$	60 57	80		dB
A_{vd}	Large signal voltage gain	$V_{out} = 0.5V$ to $2.5V$ $R_L = 2k\Omega$ $R_L = 600\Omega$	80 74	92 95		dB
V_{OH}	High level output voltage	$V_{ID} = 100mV$ $R_L = 2k\Omega$ $R_L = 600\Omega$ $T_{min} \leq T_{amb} \leq T_{max}$, $R_L = 2k\Omega$ $T_{min} \leq T_{amb} \leq T_{max}$, $R_L = 600\Omega$	2.82 2.80 2.82 2.80	2.95 2.95		V
V_{OL}	Low level output voltage	$V_{ID} = -100mV$ $R_L = 2k\Omega$ $R_L = 600\Omega$ $T_{min} \leq T_{amb} \leq T_{max}$, $R_L = 2k\Omega$ $T_{min} \leq T_{amb} \leq T_{max}$, $R_L = 600\Omega$		88 115	120 160 120 160	mV
I_o	Output source current	$V_{ID} = 100mV$, $V_O = V_{DD}$	20	80		mA
	Output sink current	$V_{ID} = -100mV$, $V_O = V_{CC}$	20	80		
I_{CC}	Supply current (per amplifier)	$V_{out} = V_{CC}/2$ $A_{VCL} = 1$, no load $T_{min} \leq T_{amb} \leq T_{max}$		450	650 690	μA
GBP	Gain bandwidth product	$R_L = 10k\Omega$, $C_L = 100pF$, $f = 100kHz$	1	1.7		MHz
SR	Slew rate	$R_L = 10k\Omega$, $C_L = 100pF$, $A_V = 1$	0.42	0.6		V/ μs
ϕ_m	Phase margin	$C_L = 100pF$		53		Degrees
en	Input voltage noise	$f = 1kHz$		27		nV/ \sqrt{Hz}
THD	Total harmonic distortion			0.01		%

1. All parameter limits at temperatures different from $25^\circ C$ are guaranteed by correlation.
2. Maximum values include unavoidable inaccuracies of the industrial tests.

Table 5. Electrical characteristics at $V_{CC} = +5V$ with $V_{DD} = 0V$, C_L & R_L connected to $V_{CC}/2$, and $T_{amb} = 25^\circ C$ (unless otherwise specified) ⁽¹⁾

Symbol	Parameter	Conditions	Min.	Typ.	Max.	Unit
V_{io}	Input offset voltage	$V_{icm} = V_{out} = V_{CC}/2$ TS1871A/2A/4A $T_{min} \leq T_{amb} \leq T_{max}$ TS1871/2/4 $T_{min} \leq T_{amb} \leq T_{max}$		0.1	1 1.5 3 6	mV
ΔV_{io}	Input offset voltage drift			2		$\mu V/^\circ C$
I_{io}	Input offset current	$V_{icm} = V_{out} = V_{CC}/2$ ⁽²⁾ $T_{min} \leq T_{amb} \leq T_{max}$		3	30 60	nA
I_{ib}	Input bias current	$V_{icm} = V_{out} = V_{CC}/2$ ⁽¹⁾ $T_{min} \leq T_{amb} \leq T_{max}$		70	130 150	nA
CMR	Common mode rejection ratio $20 \log (\Delta V_{ic}/\Delta V_{io})$	$0 \leq V_{icm} \leq V_{CC}$, V_{out} different from $V_{CC}/2$ $T_{min} \leq T_{amb} \leq T_{max}$	65 62	85		dB
SVR	Supply voltage rejection ratio $20 \log (\Delta V_{cc}/\Delta V_{io})$	$V_{CC} = 1.8$ to $5V$	70	90		dB
A_{vd}	Large signal voltage gain	$V_{out} = 1V$ to $4V$ $R_L = 2k\Omega$ $R_L = 600\Omega$	83 77	92 85		dB
V_{OH}	High level output voltage	$V_{ID} = 100mV$ $R_L = 2k\Omega$ $R_L = 600\Omega$ $T_{min} \leq T_{op} \leq T_{max}$, $R_L = 2k\Omega$ $T_{min} \leq T_{op} \leq T_{max}$, $R_L = 600\Omega$	4.80 4.75 4.80 4.75	4.95 4.90		V
V_{OL}	Low level output voltage	$V_{ID} = -100mV$ $R_L = 2k\Omega$ $R_L = 600\Omega$ $T_{min} \leq T_{op} \leq T_{max}$, $R_L = 2k\Omega$ $T_{min} \leq T_{op} \leq T_{max}$, $R_L = 600\Omega$		88 115	130 188 130 188	mV
I_o	Output source current	$V_{ID} = 100mV$, $V_O = V_{DD}$	20	80		mA
	Output sink current	$V_{ID} = -100mV$, $V_O = V_{CC}$	20	80		
I_{CC}	Supply current (per amplifier)	$V_{out} = V_{CC}/2$ $A_{VCL} = 1$, no load $T_{min} \leq T_{amb} \leq T_{max}$		500	835 875	μA
GBP	Gain bandwidth product	$R_L = 10k\Omega$, $C_L = 100pF$, $f = 100kHz$	1	1.8		MHz
SR	Slew rate	$R_L = 10k\Omega$, $C_L = 100pF$, $A_V = 1$	0.42	0.6		V/ μs
ϕ_m	Phase margin	$C_L = 100pF$		55		Degrees
en	Input voltage noise	$f = 1kHz$		27		nV/ \sqrt{Hz}
THD	Total harmonic distortion			0.01		%

1. All parameter limits at temperatures different from $25^\circ C$ are guaranteed by correlation.
 2. Maximum values include unavoidable inaccuracies of the industrial tests.

Figure 1. Input offset voltage distribution

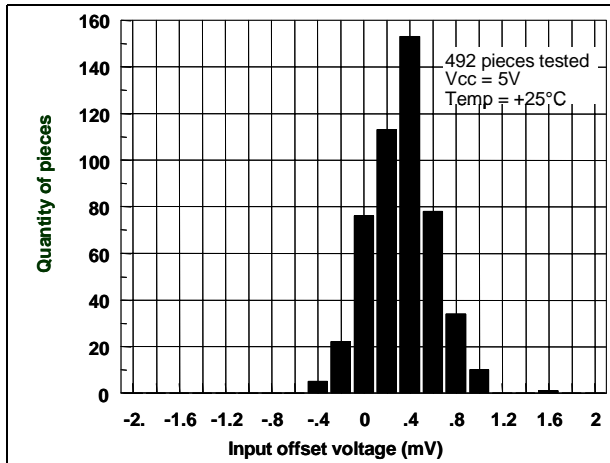

Figure 2. Input offset voltage vs. temperature

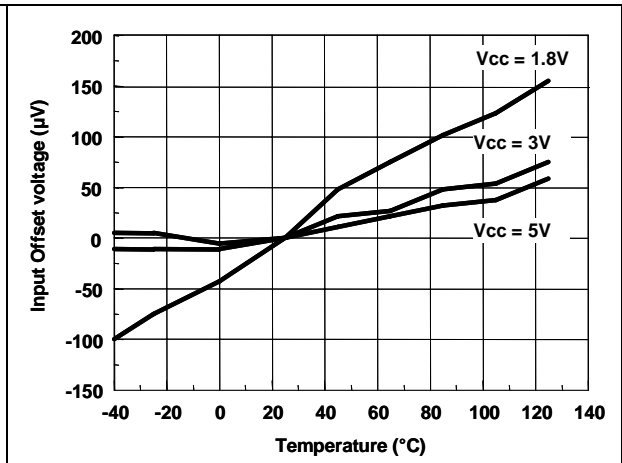

Figure 3. Input bias current vs. temperature

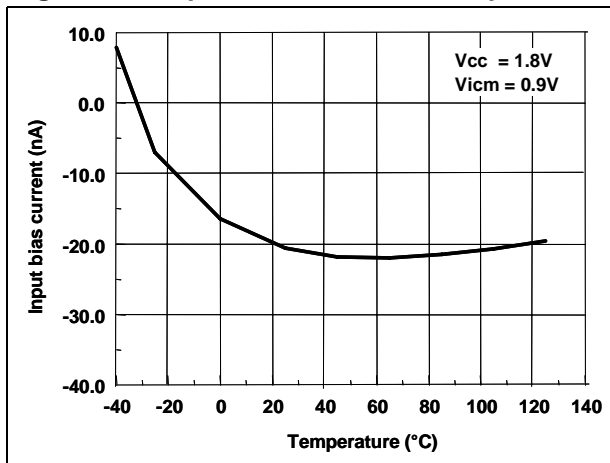

Figure 4. Input bias current vs. temperature

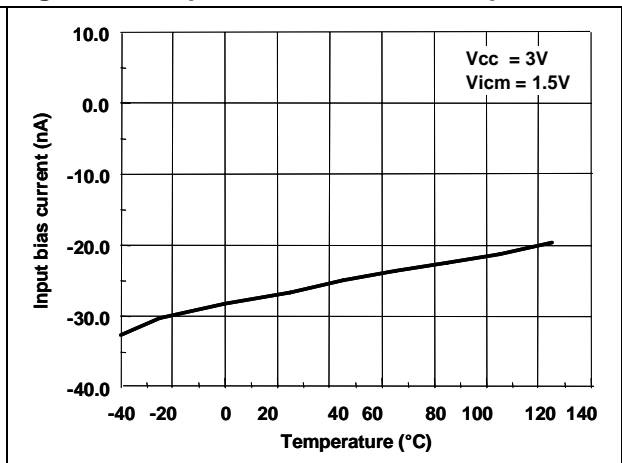

Figure 5. Supply current/amplifier vs. supply voltage

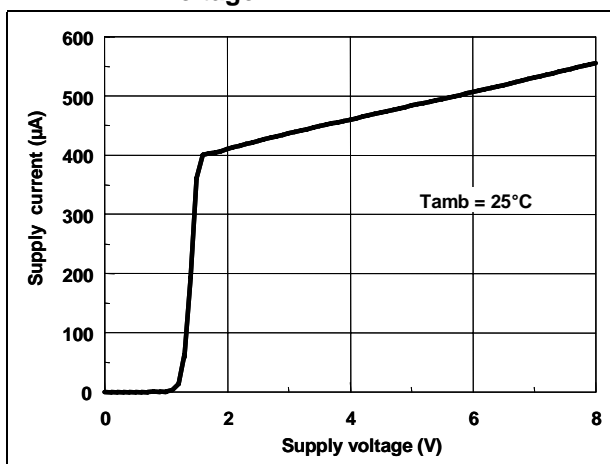

Figure 6. Supply current/amplifier vs. temperature

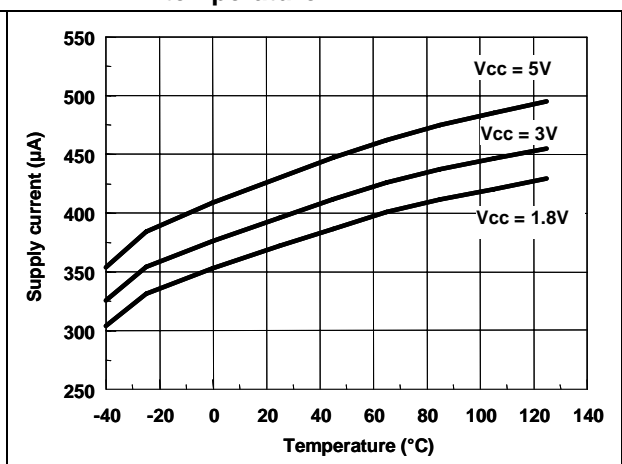

Figure 7. Common mode rejection vs. temperature

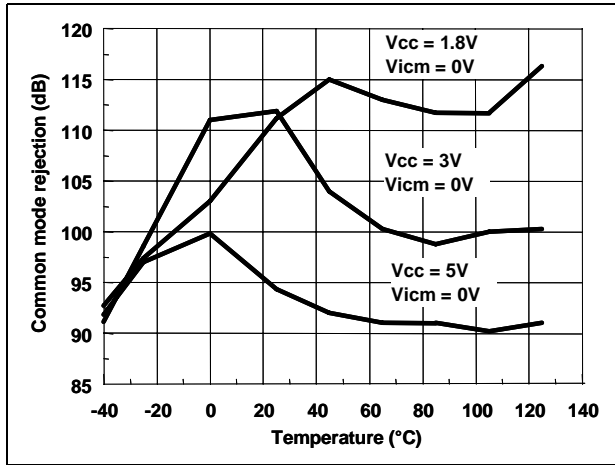

Figure 8. Supply voltage rejection vs. temperature

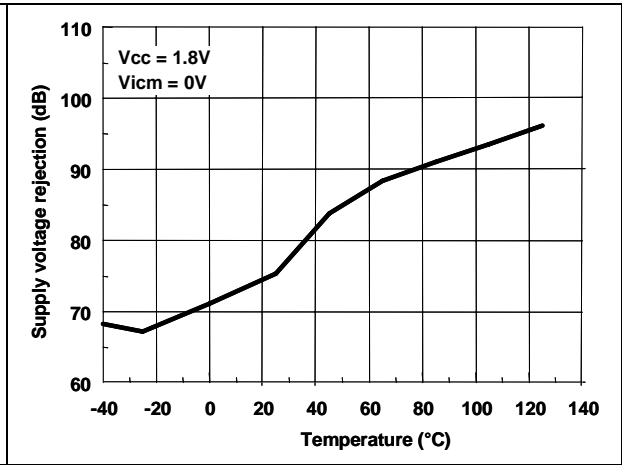

Figure 9. Supply voltage rejection vs. temperature

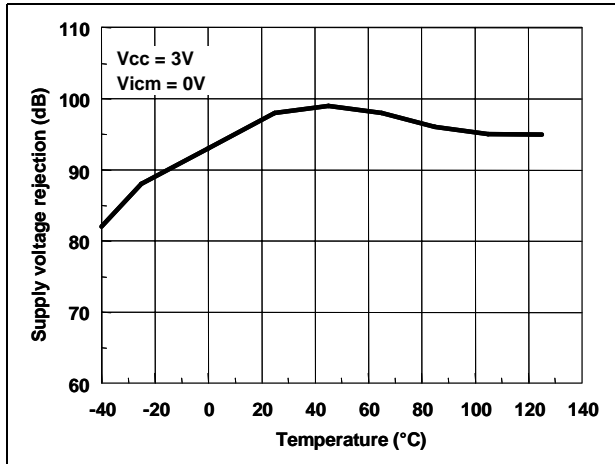

Figure 10. Supply voltage rejection vs. temperature

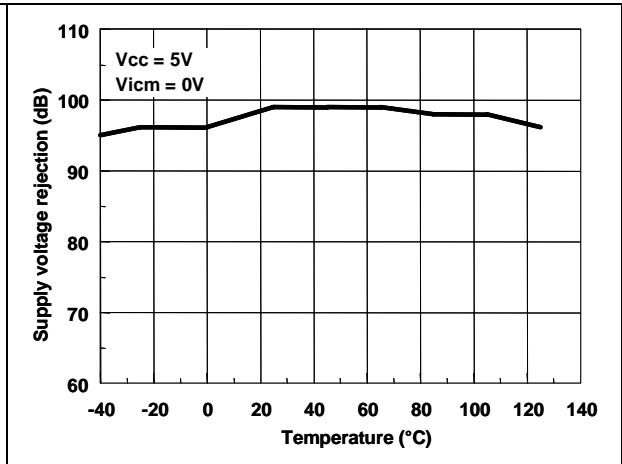

Figure 11. Power supply voltage rejection vs. frequency

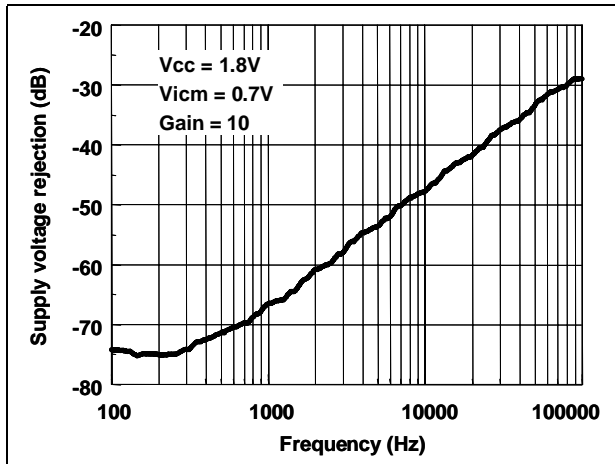

Figure 12. Open loop gain vs. frequency

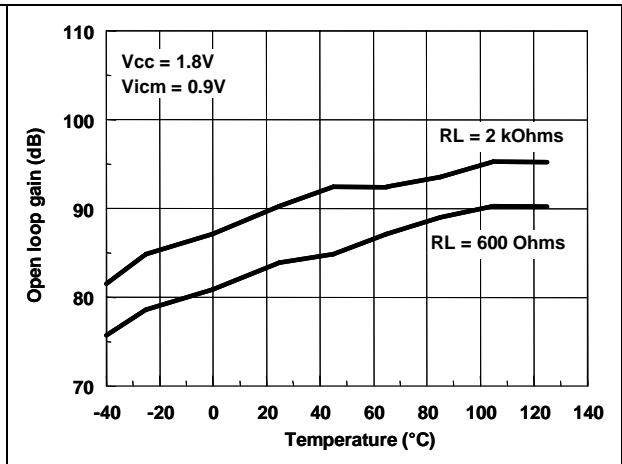

Figure 13. Open loop gain vs. temperature

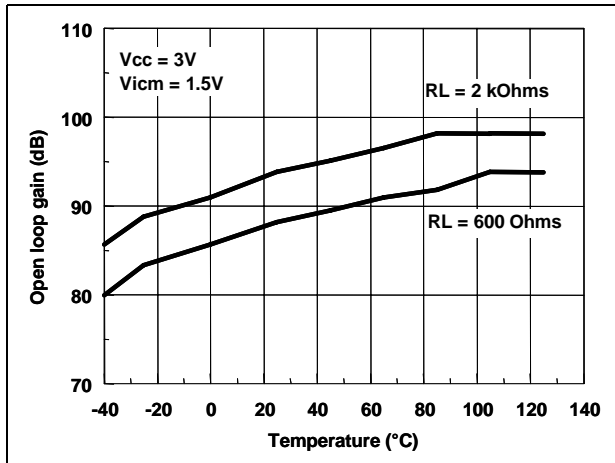

Figure 14. Open loop gain vs. temperature

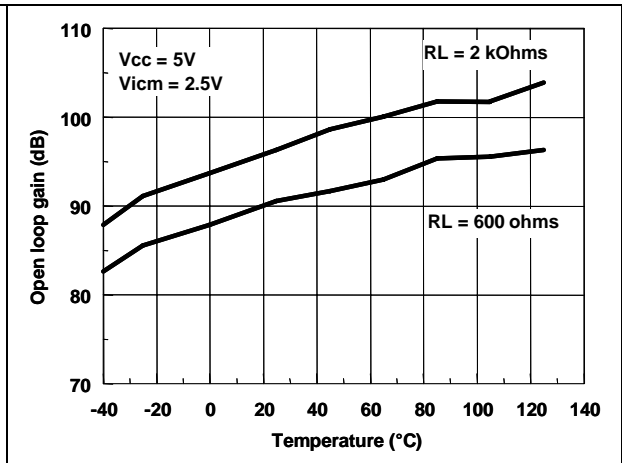

Figure 15. High level output voltage vs. temperature

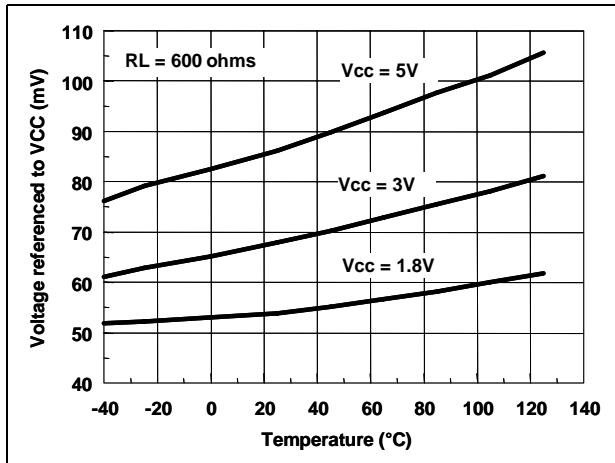

Figure 16. Low level output voltage vs. temperature

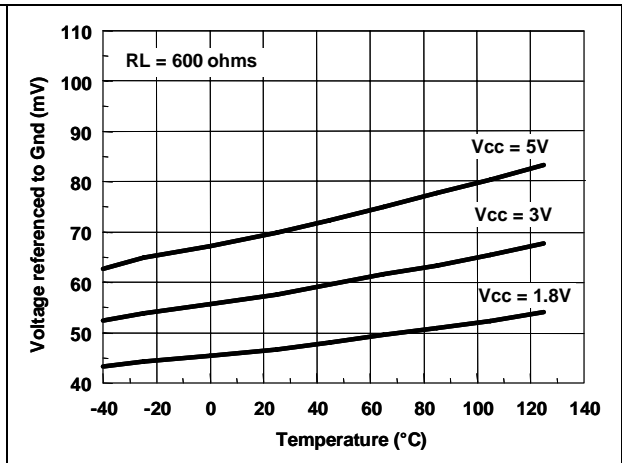

Figure 17. High level output voltage vs. temperature

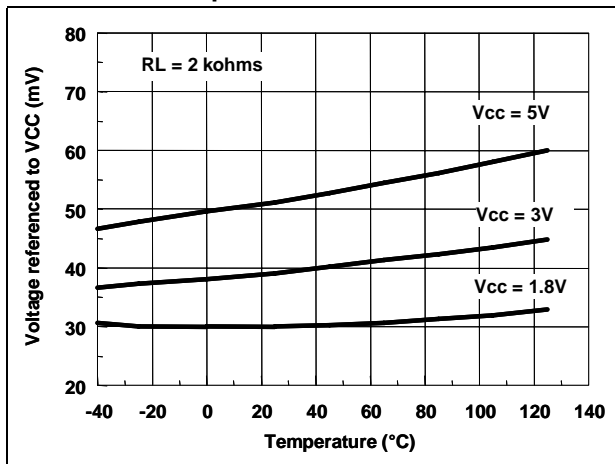

Figure 18. Low level output voltage vs. temperature

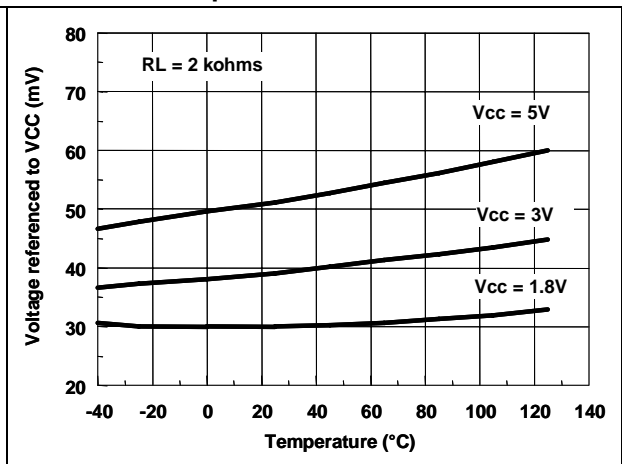

Figure 19. Output current vs. temperature

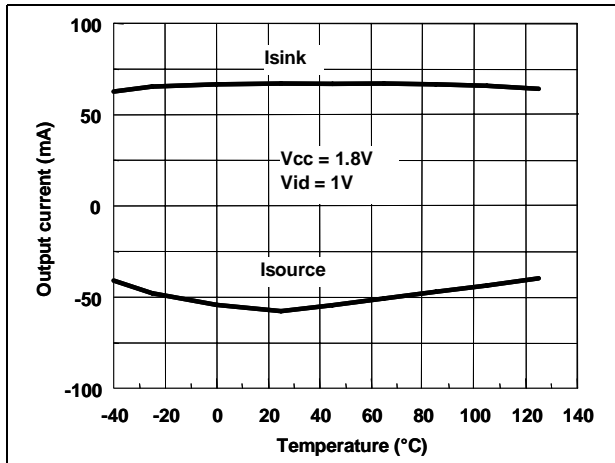

Figure 20. Output current vs. temperature

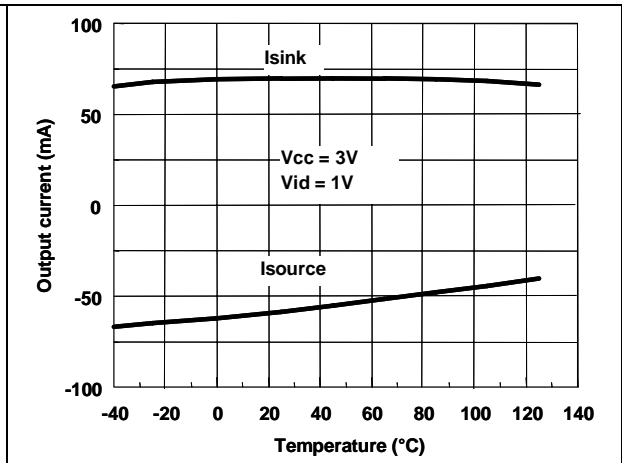

Figure 21. Output current vs. temperature

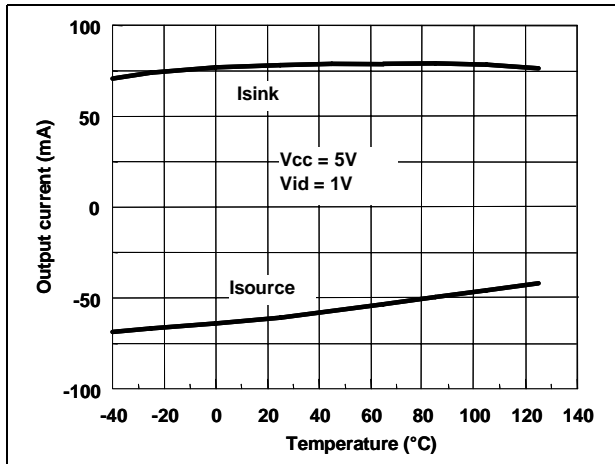

Figure 22. Output current vs. output voltage

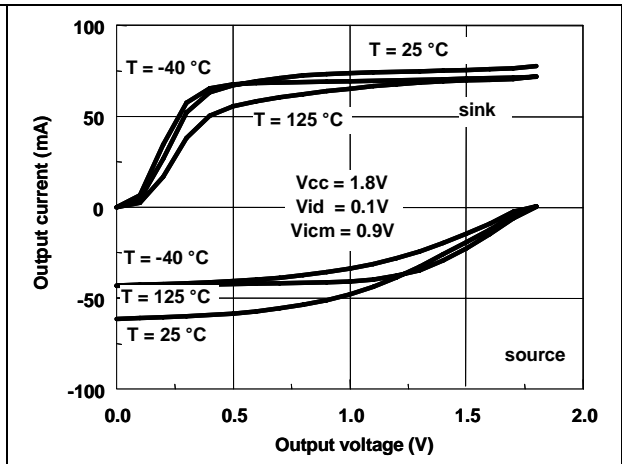

Figure 23. Output current vs. output voltage

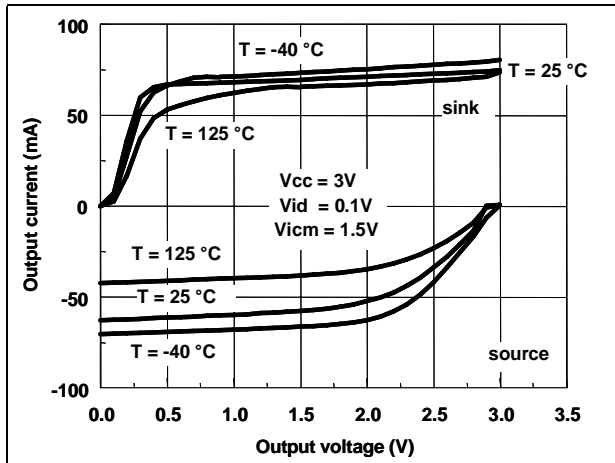

Figure 24. Output current vs. output voltage

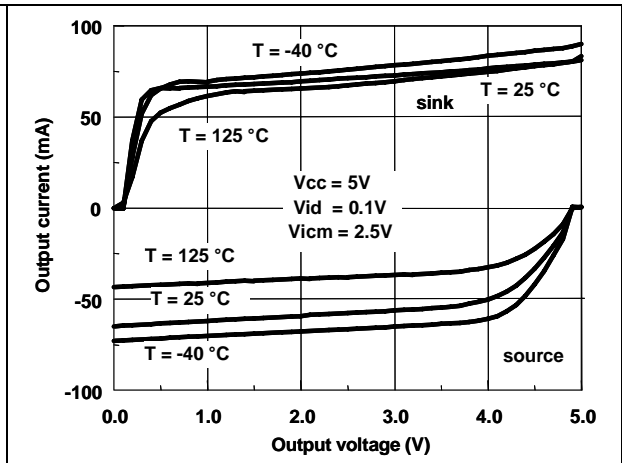

Figure 25. Gain and phase vs. frequency

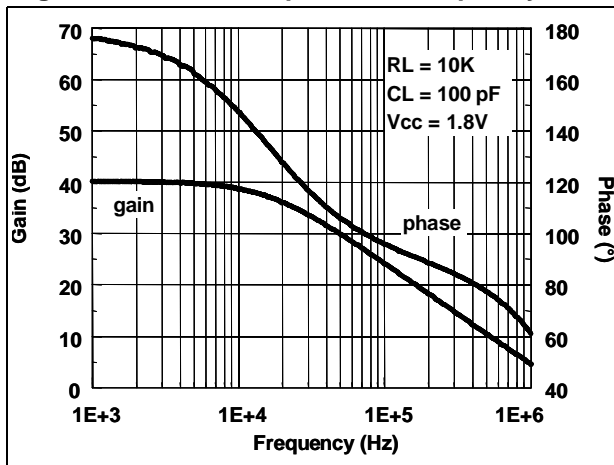

Figure 26. Gain and phase vs. frequency

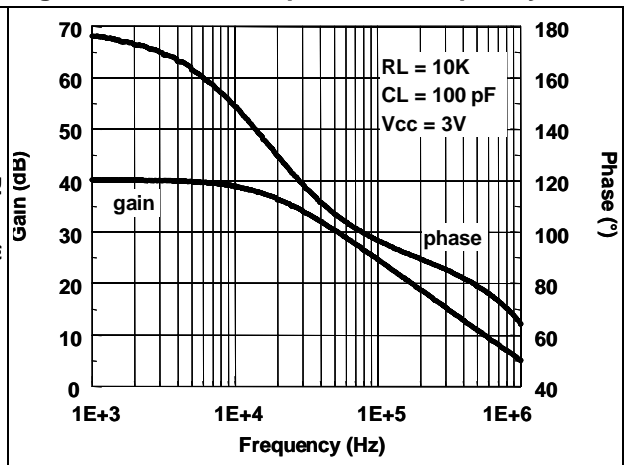

Figure 27. Gain and phase vs. frequency

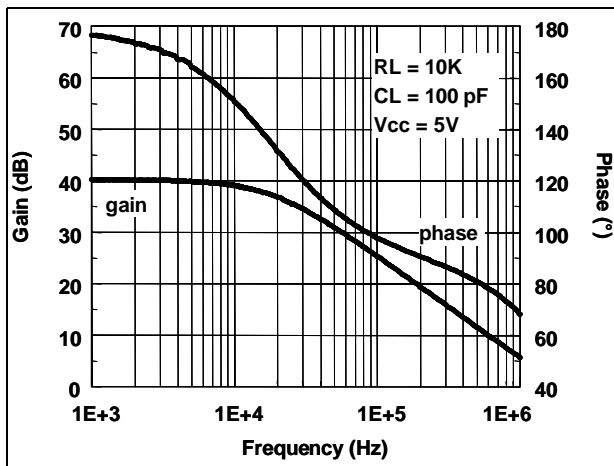

Figure 28. Gain bandwidth product vs. temperature

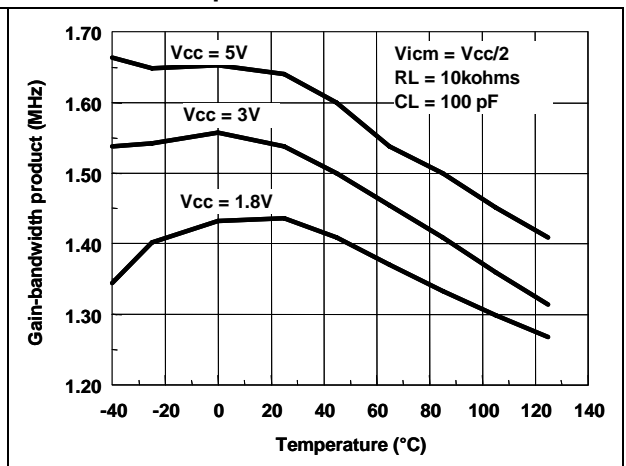

Figure 29. Gain bandwidth product vs. supply voltage

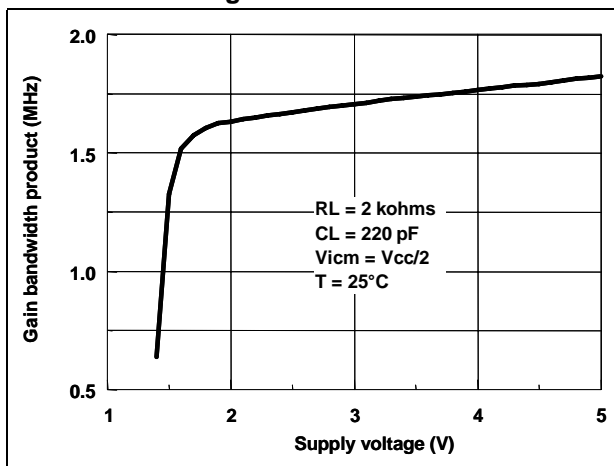

Figure 30. Slew rate vs. temperature

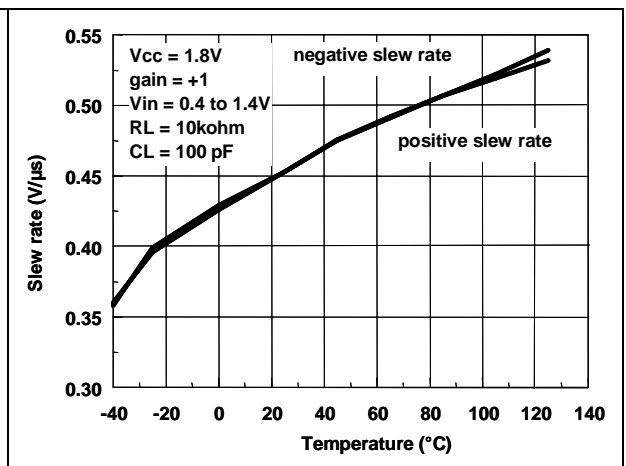

Figure 31. Slew rate vs. temperature

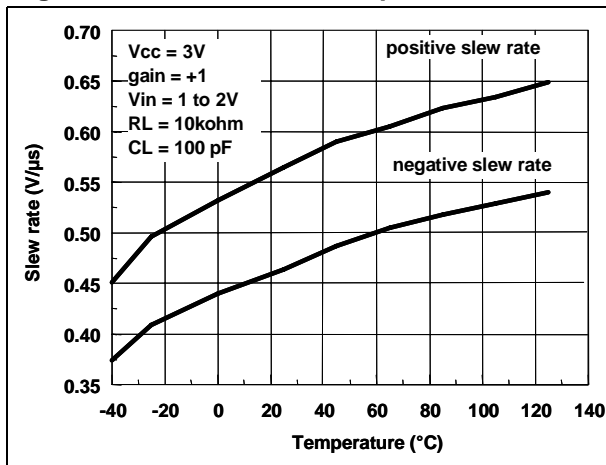

Figure 32. Slew rate vs. temperature

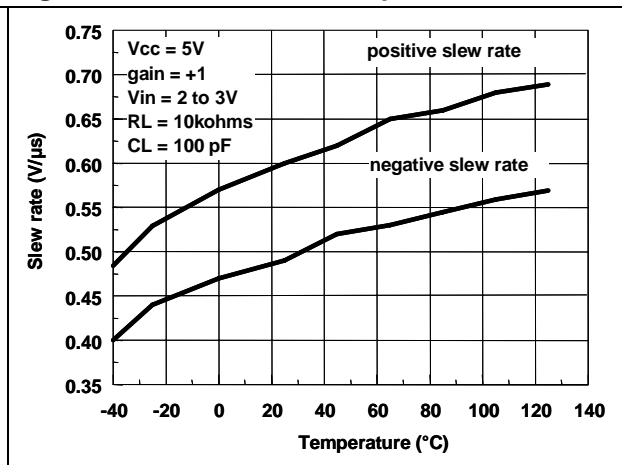

Figure 33. Phase margin vs. load capacitor

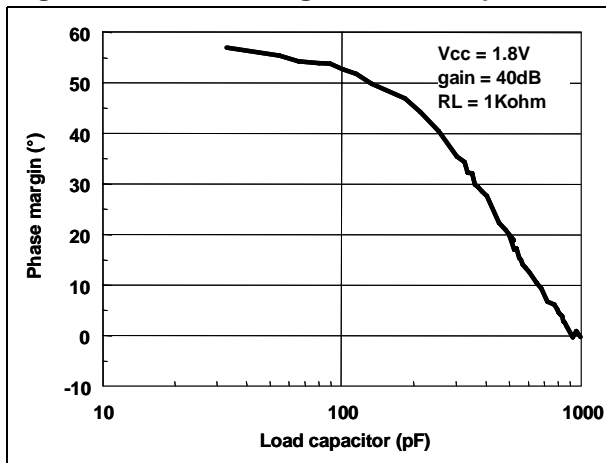

Figure 34. Phase margin vs. output current

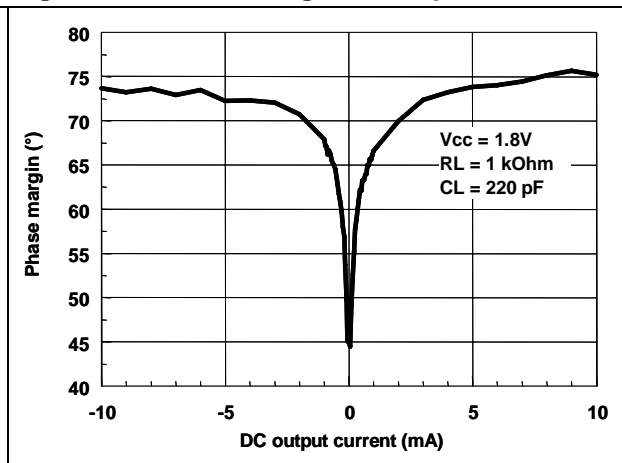

Figure 35. Gain margin vs. output current

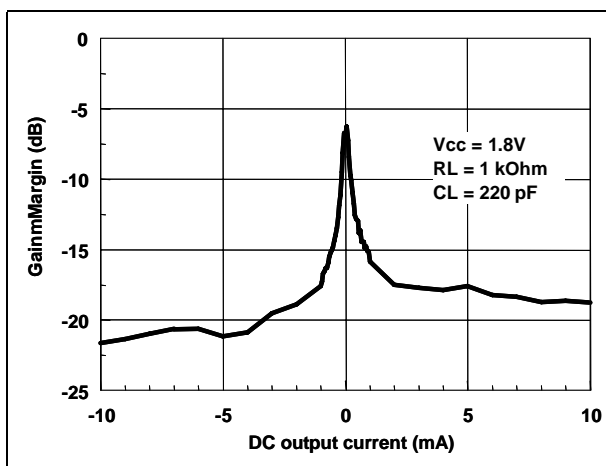

Figure 36. Equivalent input noise vs. frequency

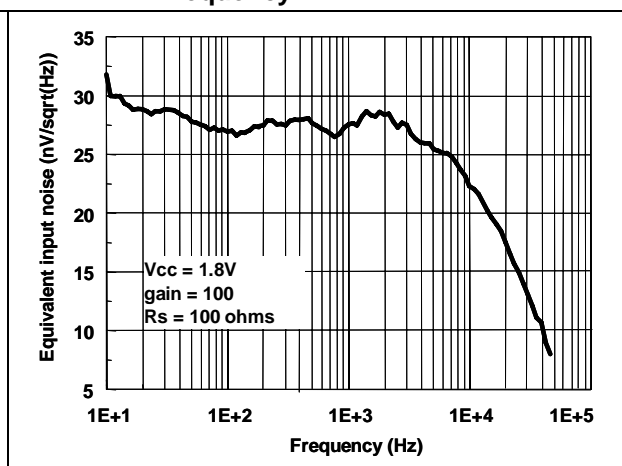

Figure 37. Distortion vs. output voltage

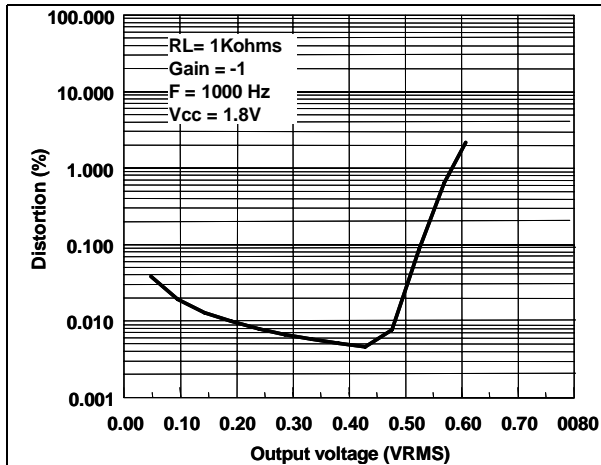

Figure 38. Distortion vs. output voltage

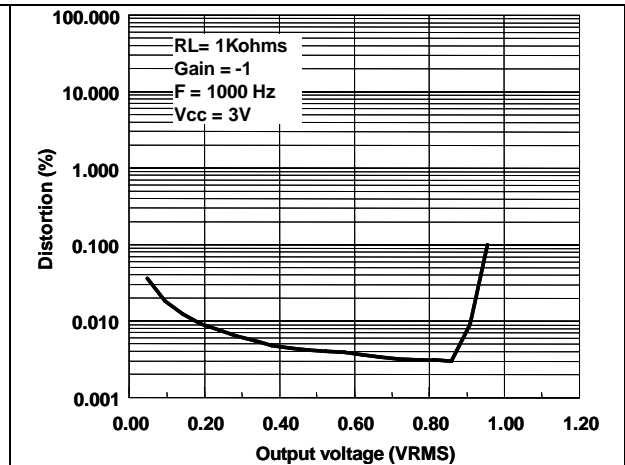

Figure 39. Distortion vs. output voltage

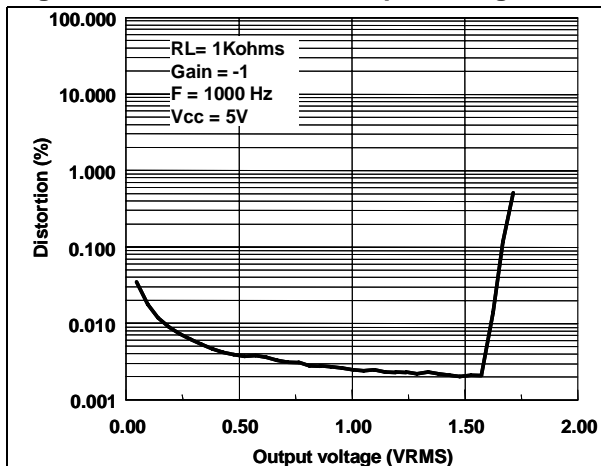

Figure 40. Distortion vs. output voltage

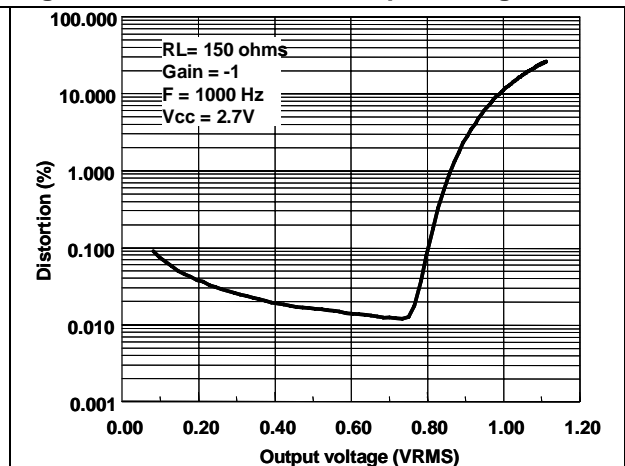

Figure 41. Distortion vs. output voltage

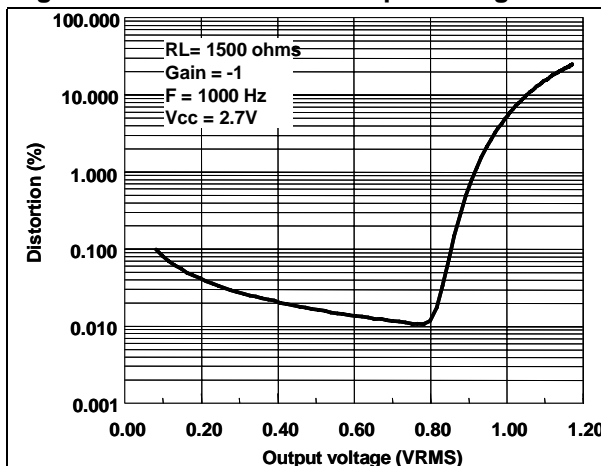

Figure 42. Distortion vs. output voltage

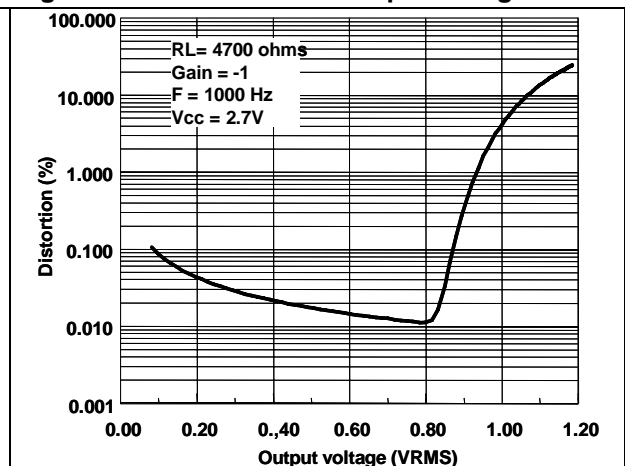

Figure 43. Distortion vs. frequency

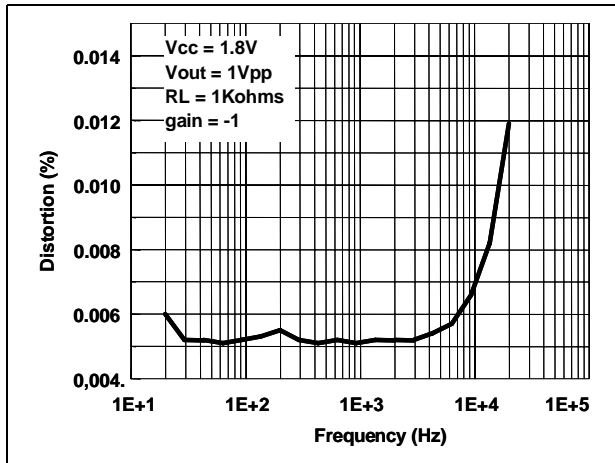

Figure 44. Distortion vs. frequency

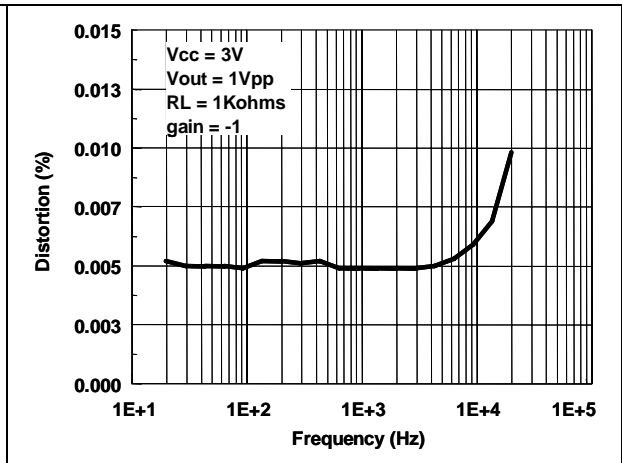

Figure 45. Distortion vs. frequency

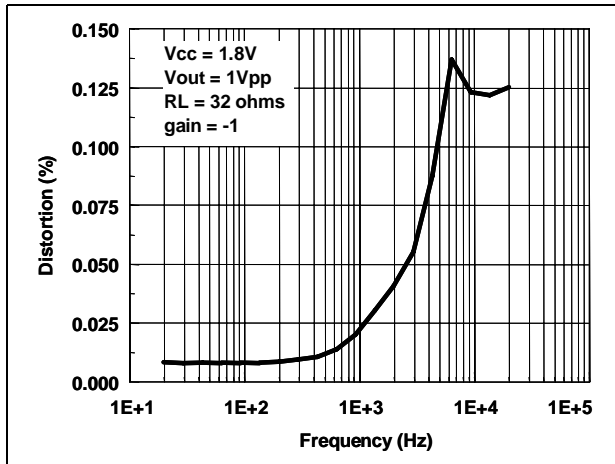

Figure 46. Distortion vs. frequency

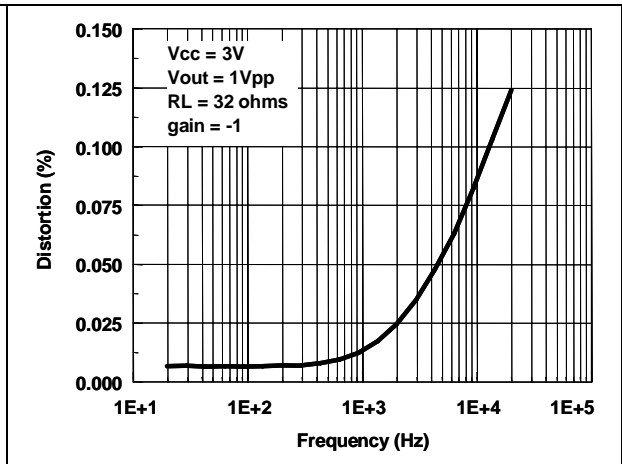
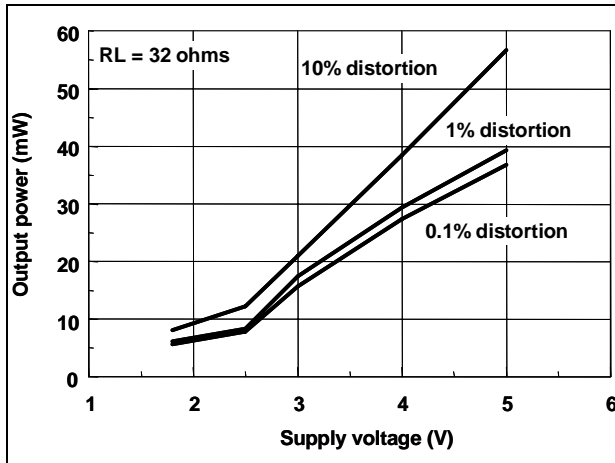

Figure 47. Output power vs. supply voltage



3 Package mechanical data

In order to meet environmental requirements, STMicroelectronics offers these devices in ECOPACK[®] packages. These packages have a lead-free second level interconnect. The category of second level interconnect is marked on the package and on the inner box label, in compliance with JEDEC Standard JESD97. The maximum ratings related to soldering conditions are also marked on the inner box label. ECOPACK is an STMicroelectronics trademark. ECOPACK specifications are available at: www.st.com.

3.1 DIP8 package

Ref.	Dimensions					
	Millimeters			Inches		
	Min.	Typ.	Max.	Min.	Typ.	Max.
A			5.33			0.210
A1	0.38			0.015		
A2	2.92	3.30	4.95	0.115	0.130	0.195
b	0.36	0.46	0.56	0.014	0.018	0.022
b2	1.14	1.52	1.78	0.045	0.060	0.070
c	0.20	0.25	0.36	0.008	0.010	0.014
D	9.02	9.27	10.16	0.355	0.365	0.400
E	7.62	7.87	8.26	0.300	0.310	0.325
E1	6.10	6.35	7.11	0.240	0.250	0.280
e		2.54			0.100	
eA		7.62			0.300	
eB			10.92			0.430
L	2.92	3.30	3.81	0.115	0.130	0.150

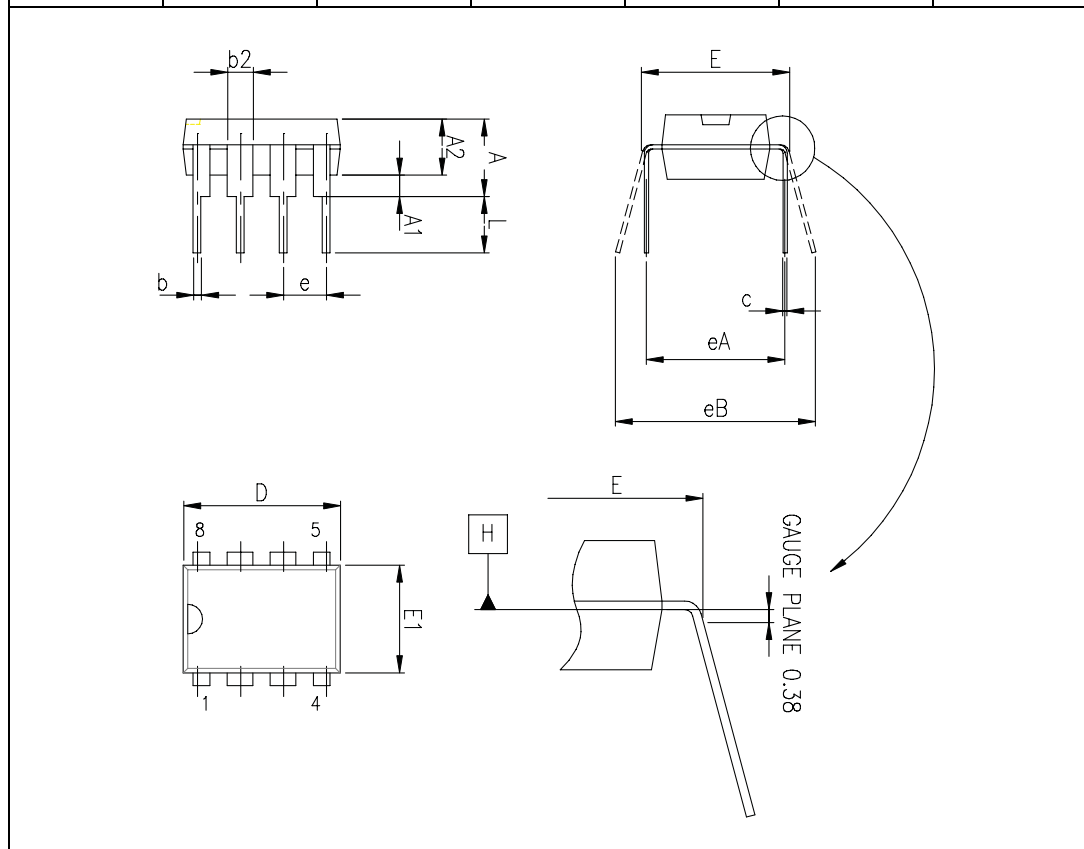

3.2 SO-8 package

Ref.	Dimensions					
	Millimeters			Inches		
	Min.	Typ.	Max.	Min.	Typ.	Max.
A			1.75			0.069
A1	0.10		0.25	0.004		0.010
A2	1.25			0.049		
b	0.28		0.48	0.011		0.019
c	0.17		0.23	0.007		0.010
D	4.80	4.90	5.00	0.189	0.193	0.197
H	5.80	6.00	6.20	0.228	0.236	0.244
E1	3.80	3.90	4.00	0.150	0.154	0.157
e		1.27			0.050	
h	0.25		0.50	0.010		0.020
L	0.40		1.27	0.016		0.050
k	1°		8°	1°		8°
ccc			0.10			0.004

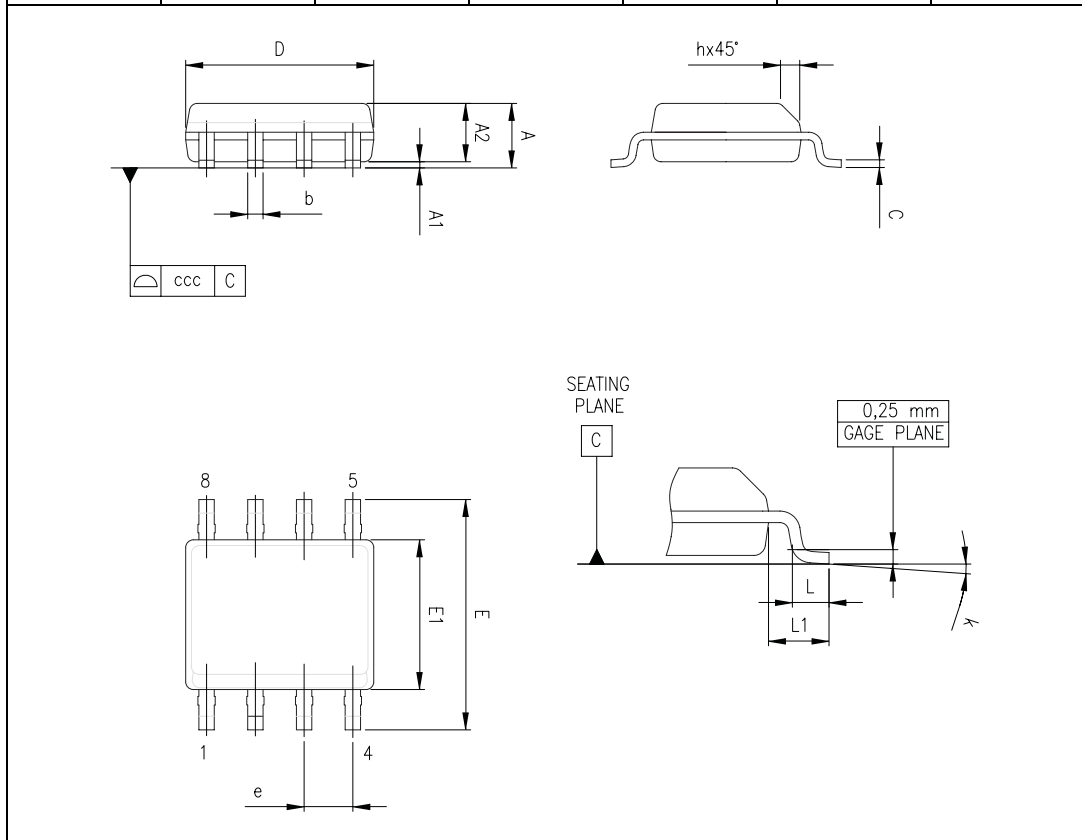

3.3 TSSOP8 package

Ref.	Dimensions					
	Millimeters			Inches		
	Min.	Typ.	Max.	Min.	Typ.	Max.
A			1.2			0.047
A1	0.05		0.15	0.002		0.006
A2	0.80	1.00	1.05	0.031	0.039	0.041
b	0.19		0.30	0.007		0.012
c	0.09		0.20	0.004		0.008
D	2.90	3.00	3.10	0.114	0.118	0.122
E	6.20	6.40	6.60	0.244	0.252	0.260
E1	4.30	4.40	4.50	0.169	0.173	0.177
e		0.65			0.0256	
k	0°		8°	0°		8°
L	0.45	0.60	0.75	0.018	0.024	0.030
L1		1			0.039	
aaa		0.1			0.004	

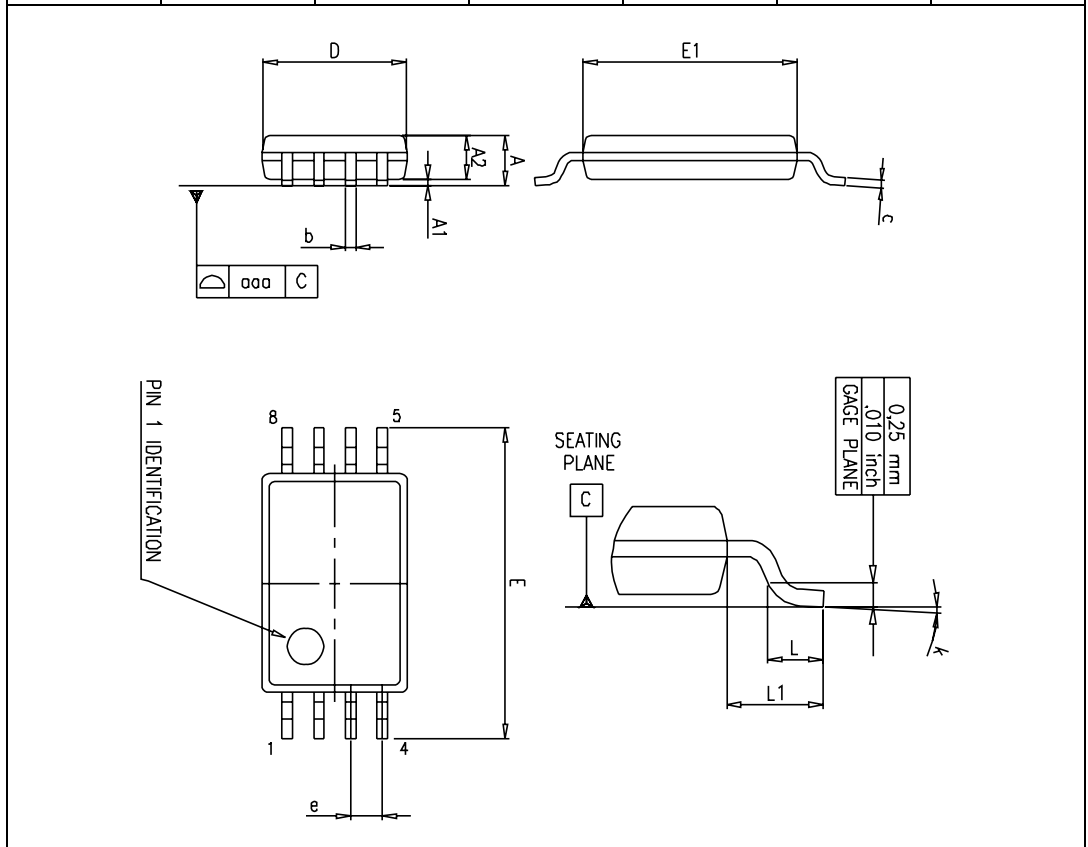

3.4 MiniSO-8 package

Ref.	Dimensions					
	Millimeters			Inches		
	Min.	Typ.	Max.	Min.	Typ.	Max.
A			1.1			0.043
A1	0.05	0.10	0.15	0.002	0.004	0.006
A2	0.78	0.86	0.94	0.031	0.034	0.037
b	0.25	0.33	0.40	0.010	0.013	0.016
c	0.13	0.18	0.23	0.005	0.007	0.009
D	2.90	3.00	3.10	0.114	0.118	0.122
E	4.75	4.90	5.05	0.187	0.193	0.199
E1	2.90	3.00	3.10	0.114	0.118	0.122
e		0.65			0.026	
K	0°		6°	0°		6°
L	0.40	0.55	0.70	0.016	0.022	0.028
L1			0.10			0.004

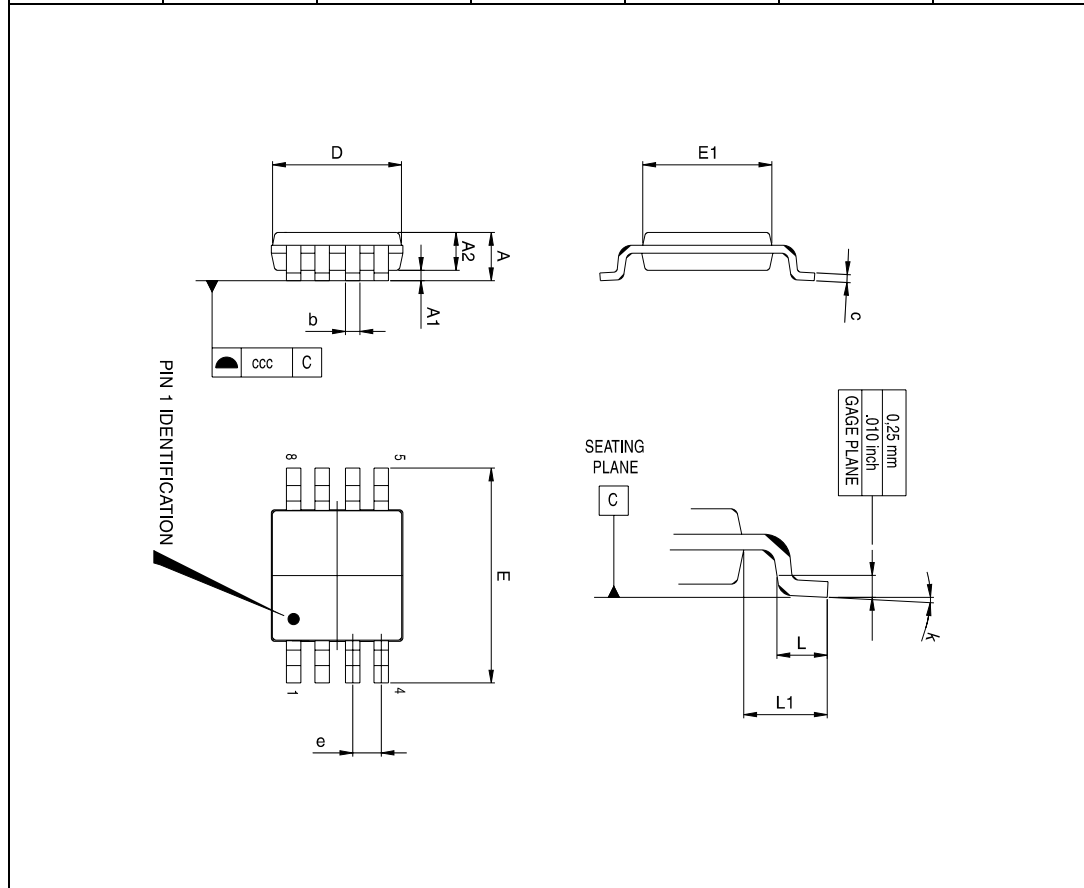

3.5 DIP14 package

Ref.	Dimensions					
	Millimeters			Inches		
	Min.	Typ.	Max.	Min.	Typ.	Max.
a1	0.51			0.020		
B	1.39		1.65	0.055		0.065
b		0.5			0.020	
b1		0.25			0.010	
D			20			0.787
E		8.5			0.335	
e		2.54			0.100	
e3		15.24			0.600	
F			7.1			0.280
l			5.1			0.201
L		3.3			0.130	
Z	1.27		2.54	0.050		0.100

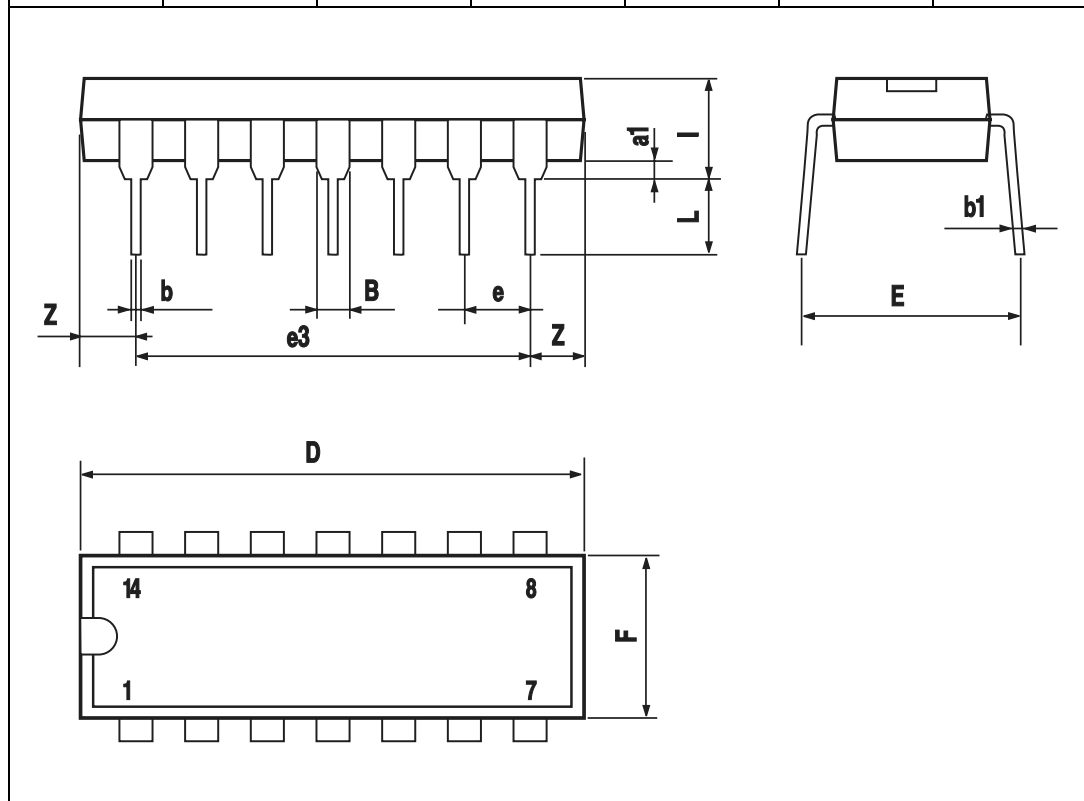

3.6 SO-14 package

Ref.	Dimensions					
	Millimeters			Inches		
	Min.	Typ.	Max.	Min.	Typ.	Max.
A			1.75			0.068
a1	0.1		0.2	0.003		0.007
a2			1.65			0.064
b	0.35		0.46	0.013		0.018
b1	0.19		0.25	0.007		0.010
C		0.5			0.019	
c1	45° (typ.)					
D	8.55		8.75	0.336		0.344
E	5.8		6.2	0.228		0.244
e		1.27			0.050	
e3		7.62			0.300	
F	3.8		4.0	0.149		0.157
G	4.6		5.3	0.181		0.208
L	0.5		1.27	0.019		0.050
M			0.68			0.026
S	8° (max.)					

The image contains three mechanical drawings of the SO-14 package:

- Side View (Top Left):** Shows the package profile with dimensions *a2*, *A*, *b*, *e*, and *e3*.
- Perspective View (Top Right):** Shows the package with dimensions *L*, *G*, *C*, *c1*, *a1*, *b1*, and *F*.
- Top View (Bottom):** Shows the package footprint with dimensions *D*, *M*, and *F*. Pin numbers 1, 7, 8, and 14 are indicated.

3.7 TSSOP14 package

Ref.	Dimensions					
	Millimeters			Inches		
	Min.	Typ.	Max.	Min.	Typ.	Max.
A			1.2			0.047
A1	0.05		0.15	0.002	0.004	0.006
A2	0.8	1	1.05	0.031	0.039	0.041
b	0.19		0.30	0.007		0.012
c	0.09		0.20	0.004		0.0089
D	4.9	5	5.1	0.193	0.197	0.201
E	6.2	6.4	6.6	0.244	0.252	0.260
E1	4.3	4.4	4.48	0.169	0.173	0.176
e		0.65 BSC			0.0256 BSC	
K	0°		8°	0°		8°
L	0.45	0.60	0.75	0.018	0.024	0.030

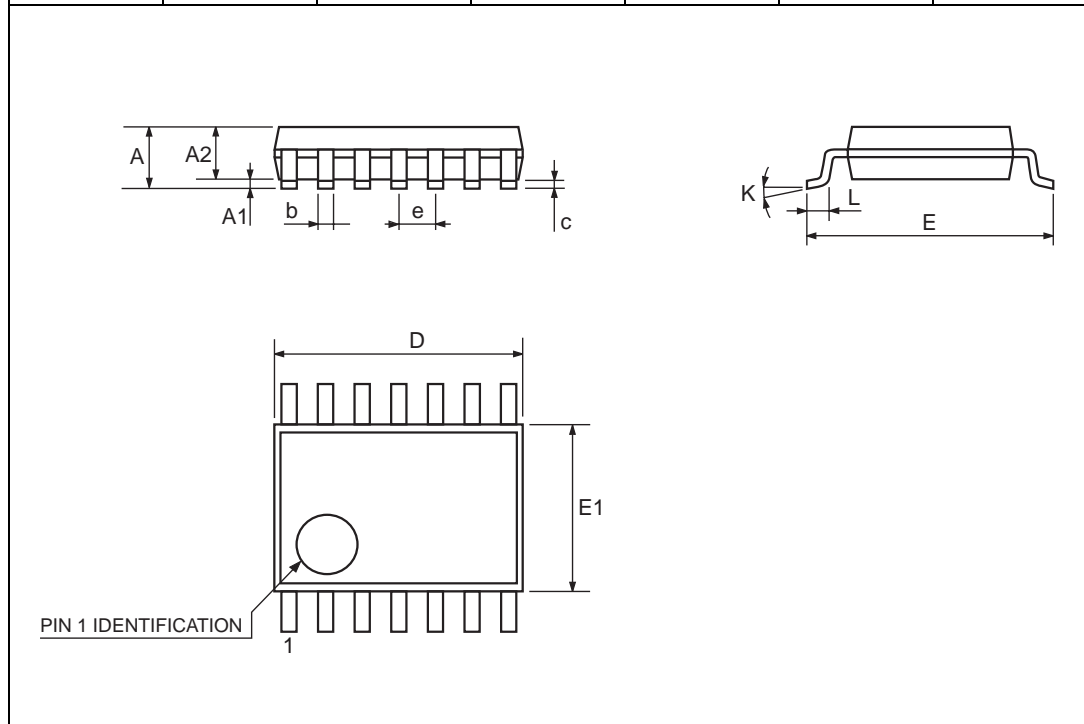

3.8 SOT23-5 package

Ref.	Dimensions					
	Millimeters			Mils		
	Min.	Typ.	Max.	Min.	Typ.	Max.
A	0.890		1.120	35.05		44.12
A1	0.010		0.100	0.39		3.94
A2	0.880	0.950	1.020	34.65	37.41	40.17
b	0.300		0.500	11.81		19.69
C	0.080		0.200	3.15		7.88
D	2.800	2.900	3.040	110.26	114.17	119.72
E	2.100		2.64	82.70		103.96
E1	1.200	1.300	1.400	47.26	51.19	55.13
e		0.950			37.41	
e1		1.900			74.82	
L	0.400		0.600	15.75		23.63
L1		0.540			21.27	
k	0°		8°	0°		8°

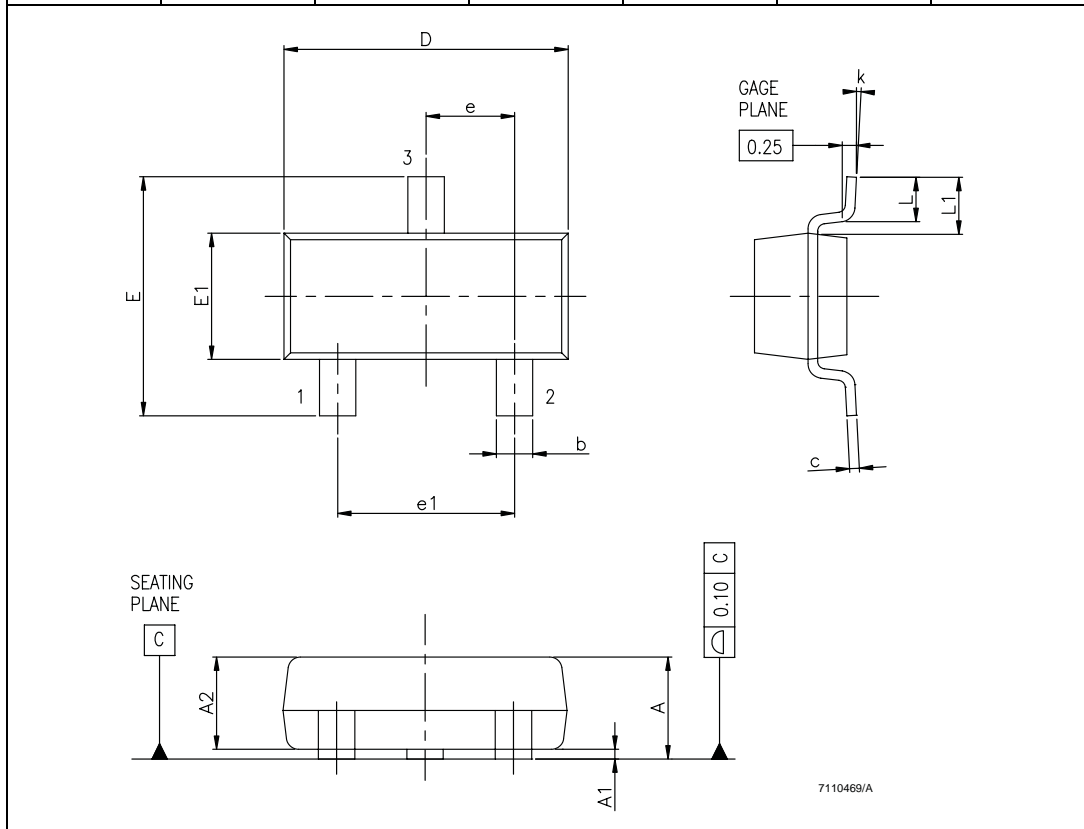

4 Ordering information

Table 6. Order codes

Part number	Temperature range	Package	Packing	Marking
TS1871ID/IDT	-40°C, +125°C	SO-8	Tube or tape & reel	1871I
TS1871IAID/AIDT				1871AI
TS1871IYD/IYDT ⁽¹⁾		SO-8 (Automotive grade)	Tube or tape & reel	1872Y
TS1871IAIYD/AIYDT ⁽¹⁾				1872AY
TS1871ILT		SOT23-5L	Tape & reel	K171
TS1871AILT				K172
TS1871IYLT ⁽¹⁾		SOT23-5L (Automotive grade)	Tape & reel	K182
TS1871AIYLT ⁽¹⁾				K183
TS1872IN		DIP8	Tube	1872IN
TS1872AIN				1872AIN
TS1872ID/IDT		SO-8	Tube or tape & reel	1872I
TS1872AID/AIDT				1872AI
TS1872IYD/IYDT ⁽¹⁾		SO-8 (Automotive grade)	Tube or tape & reel	1872Y
TS1872AIYD/AIYDT ⁽¹⁾				1872AY
TS1872IPT		TSSOP8	Tape & reel	1872I
TS1872AIPT				1872A
TS1872IYPT ⁽¹⁾		TSSOP8 (Automotive grade)	Tape & reel	1872Y
TS1872AIYPT ⁽¹⁾				872AY
TS1872IST		MiniSO-8	Tape & reel	K171
TS1872AIST				K172
TS1874IN		DIP14	Tube	1874IN
TS1874AIN				1874AIN
TS1874ID/IDT		SO-14	Tube or tape & reel	1874I
TS1874AID/AIDT				1874AI
TS1874IYD/IYDT ⁽¹⁾		SO-14 (Automotive grade)	Tube or tape & reel	TS1874Y
TS1874AIYD/AIYDT ⁽¹⁾				TS1874AY
TS1874IPT		TSSOP14	Tape & reel	1874I
TS1874AIPT				1874AI
TS1874IYPT ⁽¹⁾		TSSOP14 (Automotive grade)	Tape & reel	TS1874Y
TS1874AIYPT ⁽¹⁾				TS1874AY

1. Qualified and characterized according to AEC Q100 and Q003 or equivalent, advanced screening according to AEC Q001 & Q 002 or equivalent.

5 Revision history

Date	Revision	Changes
1-Apr-2002	1	First release.
2-Jan-2005	2	Modifications on AMR Table 1 on page 3 (explanation of V_{id} and V_i limits).
21-May-2007	4	Added limits in temperature in Table 3 on page 5 , Table 4 on page 6 , Table 5 on page 7 . Added SVR in Table 5 (SVR parameter removed from Table 3 and Table 4). Added equivalent input voltage noise in Table 3 , Table 4 , and Table 5 . Added R_{thjc} values in Table 1 . Added automotive grade part numbers to order codes table. Moved order codes table to Section 4 on page 25 . Updated format of package information.

Please Read Carefully:

Information in this document is provided solely in connection with ST products. STMicroelectronics NV and its subsidiaries ("ST") reserve the right to make changes, corrections, modifications or improvements, to this document, and the products and services described herein at any time, without notice.

All ST products are sold pursuant to ST's terms and conditions of sale.

Purchasers are solely responsible for the choice, selection and use of the ST products and services described herein, and ST assumes no liability whatsoever relating to the choice, selection or use of the ST products and services described herein.

No license, express or implied, by estoppel or otherwise, to any intellectual property rights is granted under this document. If any part of this document refers to any third party products or services it shall not be deemed a license grant by ST for the use of such third party products or services, or any intellectual property contained therein or considered as a warranty covering the use in any manner whatsoever of such third party products or services or any intellectual property contained therein.

UNLESS OTHERWISE SET FORTH IN ST'S TERMS AND CONDITIONS OF SALE ST DISCLAIMS ANY EXPRESS OR IMPLIED WARRANTY WITH RESPECT TO THE USE AND/OR SALE OF ST PRODUCTS INCLUDING WITHOUT LIMITATION IMPLIED WARRANTIES OF MERCHANTABILITY, FITNESS FOR A PARTICULAR PURPOSE (AND THEIR EQUIVALENTS UNDER THE LAWS OF ANY JURISDICTION), OR INFRINGEMENT OF ANY PATENT, COPYRIGHT OR OTHER INTELLECTUAL PROPERTY RIGHT.

UNLESS EXPRESSLY APPROVED IN WRITING BY AN AUTHORIZED ST REPRESENTATIVE, ST PRODUCTS ARE NOT RECOMMENDED, AUTHORIZED OR WARRANTED FOR USE IN MILITARY, AIR CRAFT, SPACE, LIFE SAVING, OR LIFE SUSTAINING APPLICATIONS, NOR IN PRODUCTS OR SYSTEMS WHERE FAILURE OR MALFUNCTION MAY RESULT IN PERSONAL INJURY, DEATH, OR SEVERE PROPERTY OR ENVIRONMENTAL DAMAGE. ST PRODUCTS WHICH ARE NOT SPECIFIED AS "AUTOMOTIVE GRADE" MAY ONLY BE USED IN AUTOMOTIVE APPLICATIONS AT USER'S OWN RISK.

Resale of ST products with provisions different from the statements and/or technical features set forth in this document shall immediately void any warranty granted by ST for the ST product or service described herein and shall not create or extend in any manner whatsoever, any liability of ST.

ST and the ST logo are trademarks or registered trademarks of ST in various countries.

Information in this document supersedes and replaces all information previously supplied.

The ST logo is a registered trademark of STMicroelectronics. All other names are the property of their respective owners.

© 2007 STMicroelectronics - All rights reserved

STMicroelectronics group of companies

Australia - Belgium - Brazil - Canada - China - Czech Republic - Finland - France - Germany - Hong Kong - India - Israel - Italy - Japan - Malaysia - Malta - Morocco - Singapore - Spain - Sweden - Switzerland - United Kingdom - United States of America

www.st.com

