

Varistor Products

Thermally Protected

TMOV® and iTMOV® Varistor Series



The Littelfuse TMOV and iTMOV thermally protected varistors represent a new development in integrated circuit protection (patent pending). Both versions are comprised of radial leaded MOVs (Metal Oxide Varistors) with an integrated thermally activated element designed to open in the event of overheating due to the abnormal over-voltage, limited current, conditions outlined in UL1449.

The iTMOV varistor differs from the TMOV varistor by the inclusion of a third lead for the purpose of indicating that the MOV has been disconnected from the circuit. This lead facilitates connection to monitoring circuitry.

The TMOV and iTMOV varistors offer quick thermal response due to the close proximity of the integrated thermal element to the MOV body. The integrated configuration also offers lower inductance than most discrete solutions resulting in improved clamping performance to fast over-voltage transients. Additionally, TMOV and iTMOV varistors are wave solderable, thus simplifying end product assembly by reducing the expense and rework associated with hand soldering operations.

The TMOV and iTMOV varistors are both recognized surge suppression components to UL 1449. The TMOV and iTMOV varistor's integrated thermal element, in conjunction with appropriate enclosure design, helps facilitate TVSS module compliance to UL1449 for both cord connected and permanently connected applications.

TMOV and iTMOV varistors are compatible for use with industry standard wave-soldering processes or recommended hand-soldering methods.

Features

- Patent Pending Integrated Thermal Protection Device
- Designed to facilitate compliance to UL1449 for TVSS product
- High peak surge current rating up to 10kA
- Wave solderable
- Standard lead form and spacing option
- Low Leakage
- -55°C to +85°C Operating Temperature Range
- Three-lead version available for indication purposes.

AGENCY APPROVALS:

CSA recognized.

20mm Devices-Recognized under the components program of Underwriters Laboratories UL1449 and UL1414. Includes selected tests from UL1020, regarding thermal cutoffs for devices with voltage ratings up to 420VAC.

14mm Devices-Devices are approved as an MOV to UL1449 and UL1414. Approval to selected UL1020 requirements pending. Devices (14mm and 20mm) with ratings greater than 420VAC are not affected by these abnormal voltage conditions.

Accelerated Aging Testing-14 and 20mm devices comply with Accelerated Aging Test requirements per. ANSI/IEEE C62.11 and may be used in secondary surge arrestors without repeating this test. Documented in UL file E75961.

AGENCY FILE NUMBERS: ULE56529 (UL1414)
 ULE75961 (UL1449)
 CSA LR91788

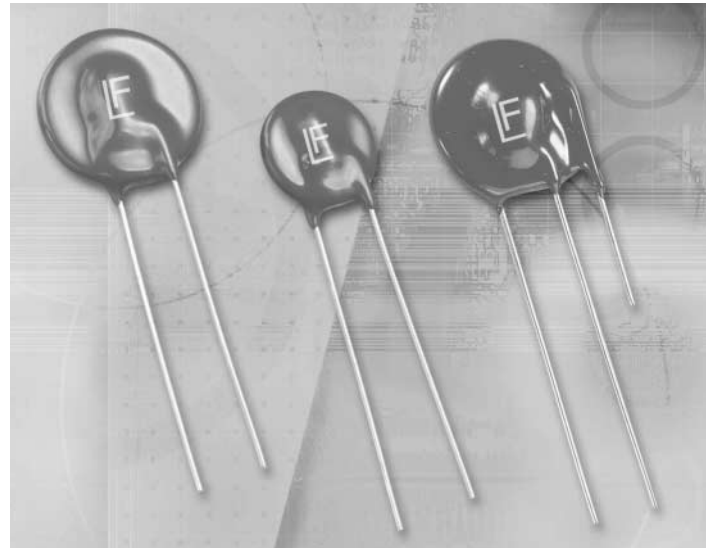

Applications

- TVSS Products
- AC Panel Protection Modules
- AC Line Power Supplies
- Surge Protected Strip Connectors
- AC Power Meters
- Relocatable AC Power Taps
- GFCI (Ground Fault Current Interrupter)
- UPS (Uninterruptable Power Supply)
- White Goods
- Plug-in TVSS
- Inverters
- AC/DC Power Supplies

Varistor Products

Thermally Protected

TMOV® and iTMOV® Varistor Series

TMOV and iTMOV Varistor Series - Absolute Maximum Ratings

Absolute Maximum Ratings For ratings of individual members of a series, see Device Ratings and Specifications chart

	TMOV / iTMOV Varistor	UNITS
Continuous:		
Steady State Applied Voltage:		
AC Voltage Range ($V_{M(AC)RMS}$)	115 to 750	V
Transient:		
Peak Pulse Current (I_{TM})		
For 8x20µs Current Wave, single pulse	6000 to 10,000	A
Single-Pulse Energy Capability		
For 2ms Current Wave	35 to 480	J
Operating Ambient Temperature Range (T_A)	-55 to 85°C	
Storage Temperature Range (T_{STG})	55 to 125°C	
Temperature Coefficient (α_V) of Clamping Voltage (V_C) at Specified Test Current	<0.01	%/°C
Hi-Pot Encapsulation (Isolation Voltage Capability)	2500	V
Thermal Protection Isolation Voltage Capability (when operated)	600	V
Insulation Resistance	1,000	MΩ
Indicator Lead Rating (Lead-3 - iTMOV varistor only):		
Continuous RMS current	100	mA
Surge Current, 8/20µs	10,000	A

2
VARISTOR PRODUCTS

CAUTION: Stresses above those listed in "Absolute Maximum Ratings" may cause permanent damage to the device. This is a stress only rating and operation of the device at these or any other conditions above those indicated in the operational sections of this specification is not implied.

Device Ratings and Specifications - TMOV Varistor Series

PART NUMBER	DEVICE MODEL NUMBER BRANDING	DISC DIAMETER (mm)	MAXIMUM RATING (85°C)						SPECIFICATIONS (25°C)				
			CONTINUOUS			TRANSIENT			VARISTOR VOLTAGE AT 1mA TEST CURRENT		MAXIMUM CLAMPING VOLTAGE 8/20µs		TYPICAL CAPACITANCE f = 1MHz
			AC VOLTS	SUPPRESSED VOLTAGE RATING	ENERGY 2ms	PEAK SURGE CURRENT 8/20µs							
			$V_{M(AC)RMS}$ (V)	UL 1449 TABLE 60.1 (V)	W_{TM} (J)	I_{TM} 1 x PULSE (A)	I_{TM} 2 x PULSE (A)	$V_{N(DC)}$ MIN (V)	$V_{N(DC)}$ MAX (V)	V_C (V)	I_{PK} (A)	C (pF)	
TMOV14R115E	4T115E	14	115	300	35	6000	4500	162	198	300	50	1100	
TMOV20R115E	20T115E	20	115	300	52	10000	6500	162	198	300	100	2400	
TMOV14R130E	4T130E	14	130	400	50	6000	4500	184	226	340	50	1000	
TMOV20R130E	20T130E	20	130	400	100	10000	6500	184	226	340	100	1900	
TMOV14R140E	4T140E	14	140	500	55	6000	4500	200	240	360	50	900	
TMOV20R140E	20T140E	20	140	400	110	10000	6500	200	240	360	100	1750	
TMOV14R150E	4T150E	14	150	500	60	6000	4500	216	264	395	50	800	
TMOV20R150E	20T150E	20	150	400	120	10000	6500	216	264	395	100	1600	
TMOV14R175E	4T175E	14	175	700	70	6000	4500	243	297	455	50	700	
TMOV20R175E	20T175E	20	175	700	135	10000	6500	243	297	455	100	1400	
TMOV14R200E	4T200E	14	200	700	75	6000	4500	281	344	530	50	630	
TMOV20R200E	20T200E	20	200	700	154	10000	6500	281	344	530	100	1250	
TMOV14R230E	4T230E	14	230	700	80	6000	4500	324	396	595	50	550	
TMOV20R230E	20T230E	20	230	700	160	10000	6500	324	396	595	100	1100	
TMOV14R250E	4T250E	14	250	800	100	6000	4500	351	429	650	50	500	
TMOV20R250E	20T250E	20	250	700	170	10000	6500	351	429	650	100	1000	
TMOV14R275E	4T275E	14	275	900	110	6000	4500	387	473	710	50	450	
TMOV20R275E	20T275E	20	275	700	190	10000	6500	387	473	710	100	900	
TMOV14R300E	4T300E	14	300	900	125	6000	4500	423	517	775	50	400	
TMOV20R300E	20T300E	20	300	900	250	10000	6500	423	517	775	100	800	

NOTE: For 14mm devices with a voltage rating greater than 420V, please contact factory regarding availability.

Varistor Products

Thermally Protected

TMOV® and iTMOV® Varistor Series

Device Ratings and Specifications - TMOV Varistor Series continued...

PART NUMBER	DEVICE MODEL NUMBER BRANDING	DISC DIA-METER (mm)	MAXIMUM RATING (85°C)					SPECIFICATIONS (25°C)					
			CONTINUOUS		TRANSIENT			VARISTOR VOLTAGE AT 1mA TEST CURRENT		MAXIMUM CLAMPING VOLTAGE 8/20 s		TYPICAL CAPACITANCE f = 1MHz	
			AC VOLTS	SUPPRESSED VOLTAGE RATING	ENERGY 2ms	PEAK SURGE CURRENT 8/20 s							
			$V_{M(AC)RMS}$	UL 1449 TABLE 60.1	W_{TM}	I_{TM} 1 x PULSE	I_{TM} 2 x PULSE	$V_{N(DC) MIN}$	$V_{N(DC) MAX}$	V_C	I_{PK}	C	
(V)	(V)	(J)	(A)	(A)	(V)		(V)	(A)	(pF)				
TMOV14R320E	4T320E	14	320	900	136	6000	4500	459	561	840	50	380	
TMOV20R320E	20T320E	20	320	900	273	10000	6500	459	561	840	100	750	
TMOV14R385E	4T385E	14	385	1200	150	6000	4500	558	682	1025	50	360	
TMOV20R385E	20T385E	20	385	1200	300	10000	6500	558	682	1025	100	700	
TMOV14R420E	4T420E	14	420	1200	160	6000	4500	612	748	1120	50	300	
TMOV20R420E	20T420E	20	420	1200	320	10000	6500	612	748	1120	100	600	
TMOV20R460E	20T460E	20	460	n/a	360	10000	6500	675	825	1240	100	200	
TMOV20R510E	20T510E	20	510	n/a	325	10000	6500	738	902	1355	100	350	
TMOV20R550E	20T550E	20	550	n/a	360	10000	6500	819	1001	1500	100	300	
TMOV20R575E	20T575E	20	575	n/a	375	10000	6500	856	1047	1568	100	275	
TMOV20R625E	20T625E	20	625	n/a	52	10000	6500	900	1100	1650	100	250	
TMOV20R750E	20T750E	20	750	n/a	100	10000	6500	1080	1320	1980	100	175	

NOTE: For 14mm devices with a voltage rating greater than 420V, please contact factory regarding availability.

Device Ratings and Specifications - iTMOV Varistor Series

PART NUMBER	DEVICE MODEL NUMBER BRANDING	DISC DIA-METER (mm)	MAXIMUM RATING (85°C)					SPECIFICATIONS (25°C)					
			CONTINUOUS		TRANSIENT			VARISTOR VOLTAGE AT 1mA TEST CURRENT		MAXIMUM CLAMPING VOLTAGE 8/20µs		TYPICAL CAPACITANCE f = 1MHz	
			AC VOLTS	SUPPRESSED VOLTAGE RATING	ENERGY 2ms	PEAK SURGE CURRENT 8/20µs							
			$V_{M(AC)RMS}$	UL 1449 TABLE 60.1	W_{TM}	I_{TM} 1 x PULSE	I_{TM} 2 x PULSE	$V_{N(DC) MIN}$	$V_{N(DC) MAX}$	V_C	I_{PK}	C	
(V)	(V)	(J)	(A)	(A)	(V)		(V)	(A)	(pF)				
TMOV14R115M	4T115M	14	115	300	35	6000	4500	162	198	300	50	1100	
TMOV20R115M	20T115M	20	115	300	52	10000	6500	162	198	300	100	2400	
TMOV14R130M	4T130M	14	130	400	50	6000	4500	184	226	340	50	1000	
TMOV20R130M	20T130M	20	130	400	100	10000	6500	184	226	340	100	1900	
TMOV14R140M	4T140M	14	140	500	55	6000	4500	200	240	360	50	900	
TMOV20R140M	20T140M	20	140	400	110	10000	6500	200	240	360	100	1750	
TMOV14R150M	4T150M	14	150	500	60	6000	4500	216	264	395	50	800	
TMOV20R150M	20T150M	20	150	400	120	10000	6500	216	264	395	100	1600	
TMOV14R175M	4T175M	14	175	700	70	6000	4500	243	297	455	50	700	
TMOV20R175M	20T175M	20	175	700	135	10000	6500	243	297	455	100	1400	
TMOV14R200M	4T200M	14	200	700	75	6000	4500	281	344	530	50	630	
TMOV20R200M	20T200M	20	200	700	154	10000	6500	281	344	530	100	1250	
TMOV14R230M	4T230M	14	230	700	80	6000	4500	324	396	595	50	550	
TMOV20R230M	20T230M	20	230	700	160	10000	6500	324	396	595	100	1100	
TMOV14R250M	4T250M	14	250	800	100	6000	4500	351	429	650	50	500	
TMOV20R250M	20T250M	20	250	700	170	10000	6500	351	429	650	100	1000	
TMOV14R275M	4T275M	14	275	900	110	6000	4500	387	473	710	50	450	
TMOV20R275M	20T275M	20	275	700	190	10000	6500	387	473	710	100	900	
TMOV14R300M	4T300M	14	300	900	125	6000	4500	423	517	775	50	400	
TMOV20R300M	20T300M	20	300	900	250	10000	6500	423	517	775	100	800	

NOTE: For 14mm devices with a voltage rating greater than 420V, please contact factory regarding availability.

Varistor Products

Thermally Protected

TMOV® and iTMOV® Varistor Series

Device Ratings and Specifications - iTMOV Varistor Series continued...

PART NUMBER	DEVICE MODEL NUMBER BRAND-ING	DISC DIA-METER (mm)	MAXIMUM RATING (85°C)						SPECIFICATIONS (25°C)				
			CONTINUOUS		TRANSIENT				VARISTOR VOLTAGE AT 1mA TEST CURRENT		MAXIMUM CLAMPING VOLTAGE 8/20 s		TYPICAL CAPACITANCE f = 1MHz
			AC VOLTS	SUPPRESSED VOLTAGE RATING	ENERGY 2ms	PEAK SURGE CURRENT 8/20 s							
			$V_{M(AC)RMS}$ (V)	UL 1449 TABLE 60.1 (V)	W_{TM} (J)	I_{TM} 1 x PULSE (A)	I_{TM} 2 x PULSE (A)	$V_{N(DC) MIN}$ (V)	$V_{N(DC) MAX}$ (V)	V_C (V)	I_{PK} (A)	C (pF)	
TMOV14R320M	4T320M	14	320	900	136	6000	4500	459	561	840	50	380	
TMOV20R320M	20T320M	20	320	900	273	10000	6500	459	561	840	100	750	
TMOV14R385M	4T385M	14	385	1200	150	6000	4500	558	682	1025	50	360	
TMOV20R385M	20T385M	20	385	1200	300	10000	6500	558	682	1025	100	700	
TMOV14R420M	4T420M	14	420	1200	160	6000	4500	612	748	1120	50	300	
TMOV20R420M	20T420M	20	420	1200	320	10000	6500	612	748	1120	100	600	
TMOV20R460M	20T460M	20	460	n/a	360	10000	6500	675	825	1240	100	200	
TMOV20R510M	20T510M	20	510	n/a	325	10000	6500	738	902	1355	100	350	
TMOV20R550M	20T550M	20	550	n/a	360	10000	6500	819	1001	1500	100	300	
TMOV20R575M	20T575M	20	575	n/a	375	10000	6500	856	1047	1568	100	275	
TMOV20R625M	20T625M	20	625	400	52	10000	6500	900	1100	1650	100	250	
TMOV20R750M	20T750M	20	750	480	100	10000	6500	1080	1320	1980	100	175	

NOTE: For 14mm devices with a voltage rating greater than 420V, please contact factory regarding availability.

Varistor Products

Thermally Protected

TMOV® and iTMOV® Varistor Series

Lead Configurations

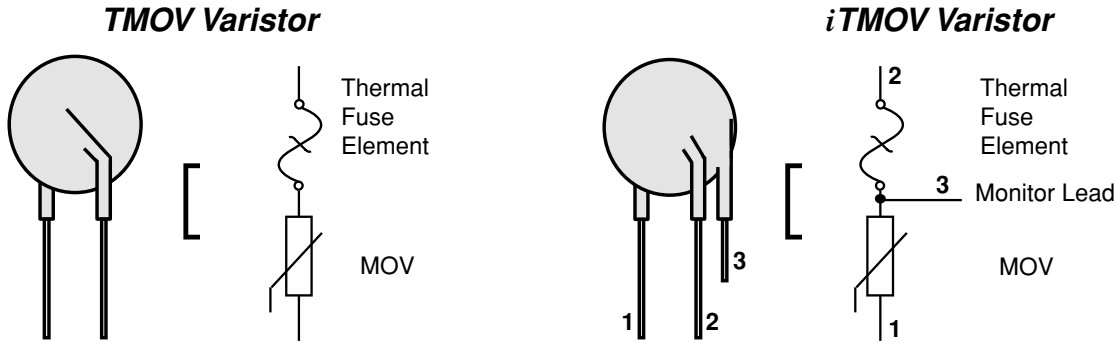

2
VARISTOR PRODUCTS

Note: MOVs are non-polarized passive elements

iTMOV Varistor Application Examples

The application examples below show how the indicator lead on the iTMOV can be used to indicate that the thermal element has been opened. This signifies that the circuit is no longer protected from transients by the MOV.

Application Example 1 (Figure 1)

In this case, the LED is normally on, and is off when the thermal element opens.

Application Example 2 (Figure 2)

This circuit utilizes an optocoupler to provide galvanic isolations between the iTMOV varistor and the indicating or alarm circuitry.

Application Example 3 (Figure 3)

This circuit illustrates the use of the monitoring lead of the iTMOV varistor to ensure that equipment is only operated when overvoltage protection present. In normal operation the load switch relay solenoid is powered via the indicator lead of the iTMOV varistor. In the event of the thermal element being activated, the relay will de-activate, cutting power to the protected circuit and the fault LED will illuminate.

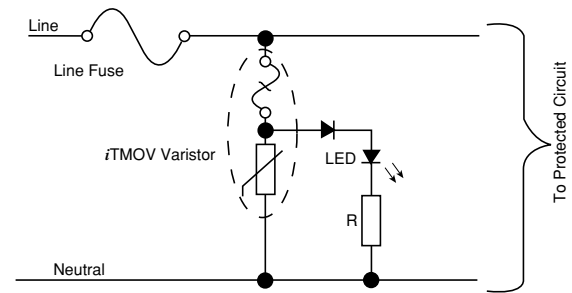

Figure 1. Application example 1

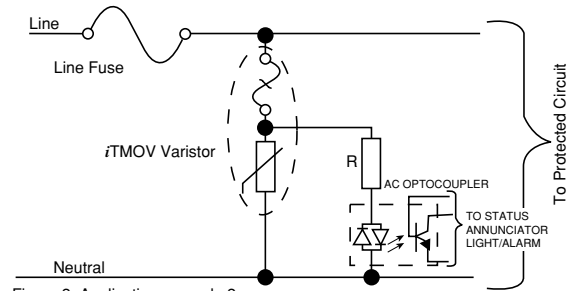

Figure 2. Application example 2

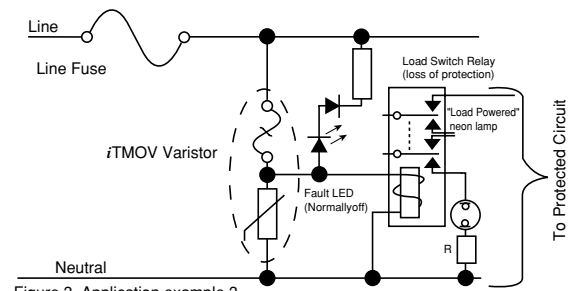

Figure 3. Application example 3

Please note: Indicator circuits are provided as a guideline only. Verification of actual indicator circuitry is the responsibility of the end user. Component values selected must be appropriate for the specific AC line voltage service and application.

Varistor Products

Thermally Protected

TMOV® and iTMOV® Varistor Series

Thermal Characteristics

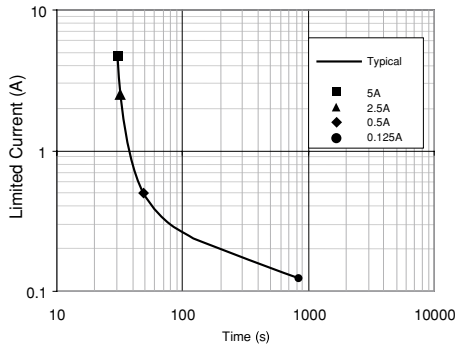

* Figure 4: Typical time to open circuit under UL1449 Abnormal Overvoltage Limited Current Test

Note : The TMOV and iTMOV varistors are intended, in conjunction with appropriate enclosure design, to help facilitate TVSS module compliance to UL 1449, Section 37.4 (abnormal over-voltage limited current requirements). Under these extreme abnormal over-voltage conditions, the units will exhibit substantial heating and potential venting prior to opening. Modules should be designed to contain this possibility. Application testing is strongly recommended.

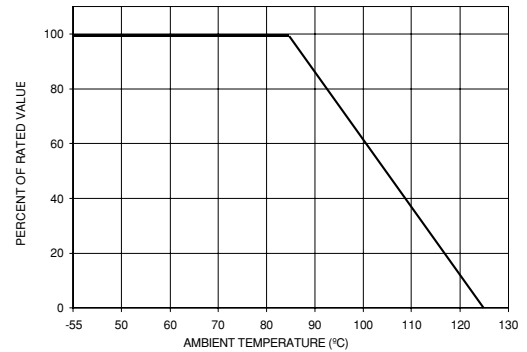

Figure 5: Peak Current & Energy Derating Curve

For applications exceeding 85°C ambient temperature, the peak surge current and energy ratings must be reduced as shown in Figure 3.

Transient V-I Characteristic Curves

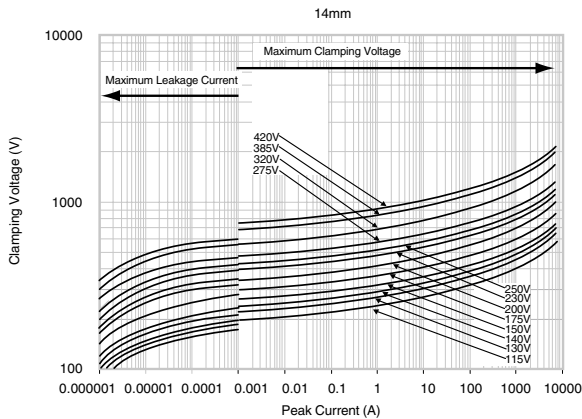

Figure 6: V-I Characteristic Curves for 14mm Types

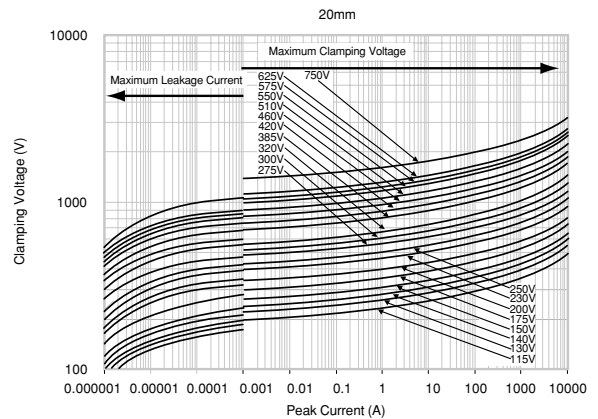

Figure 7: V-I Characteristic Curves for 20mm Types

Pulse Rating Curves

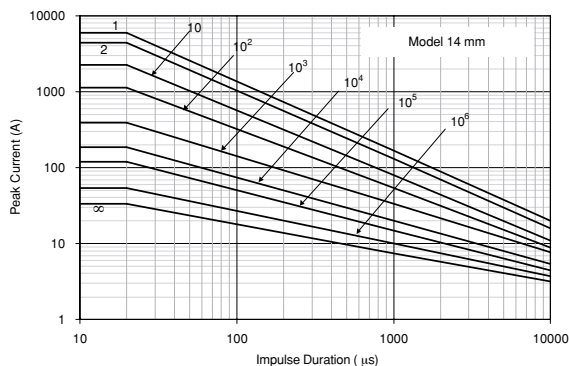

Figure 8: Pulse Rating Curves for 14mm types

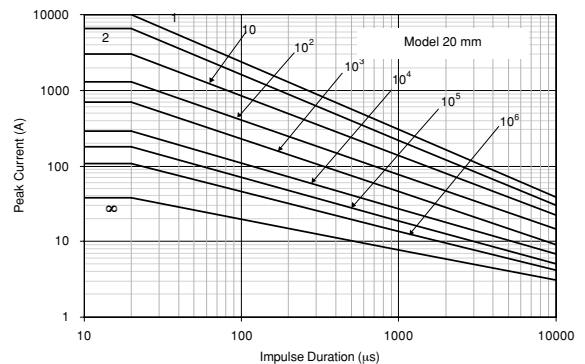

Figure 9: Pulse Rating Curves for 20mm types

Varistor Products

Thermally Protected

TMOV® and iTMOV® Varistor Series

Soldering Recommendations

Because the TMOV™ and iTMOV varistors contain a thermal protection device, care must be taken when soldering the devices into place. Two soldering methods are possible. Firstly, hand soldering: It is recommended to heat-sink the leads of the device. Secondly, wave-soldering: It is critically important that all preheat stage and the solder bath temperatures are rigidly controlled. The recommended solder for the TMOV and iTMOV varistors is a 62/36/2 (Sn/Pb/Ag), 60/40 (Sn/Pb) or 63/37(Sn/Pb). Littelfuse also recommends an RMA solder flux.

Figure 10: Wave Solder Profile

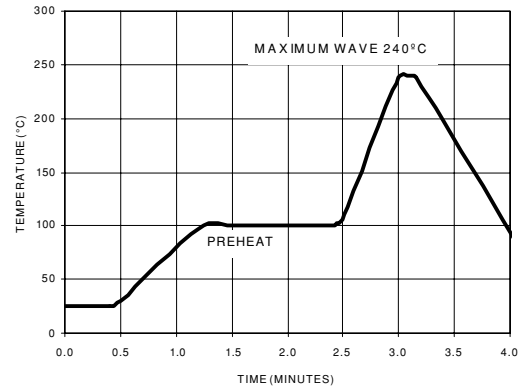

Ordering Information

Standard Parts

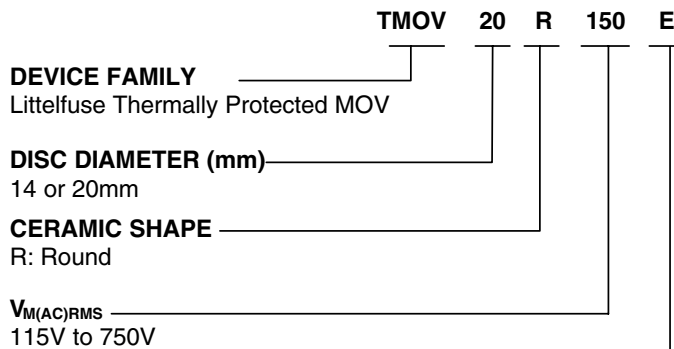

Series Designator

E: 2-Leaded TMOV Varistor Series
Supplied in Bulk Pack with 7.5mm lead spacing.

M: 3-Leaded iTMOV Varistor Series
Supplied in Bulk Pack with 7.5mm lead spacing (between leads 1 & 2)

NOTE: By ordering the standard part number, i.e. TMOV20R150E, standard lead styles, packing and lead spacing will be supplied. These specifications are as follows:

- Straight Leads
- Bulk Packed
- 7.5mm Lead Spacing
- Leads not in-line except parts > 420 V

Additional Options

Tape and Reel

- Add suffix L2T7 to the end of standard part number (ex. TMOV20R150EL2T7)
- Tape and Reeled parts have in-line, crimped leads. See drawings on pg 32.

Alternative Leadstyles:

- Contact factory for details

Varistor Products

Thermally Protected

TMOV® and iTMOV® Varistor Series

General Dimensions, Bulk Pack Non-Crimped Devices

SYMBOL	Vrms Model Voltage	TMOV Varistor				iTMOV Varistor			
		Model Size							
		14mm		20mm		14mm		20mm	
		MIN mm (in)	MAX mm (in)	MIN mm (in)	MAX mm (in)	MIN mm (in)	MAX mm (in)	MIN mm (in)	MAX mm (in)
A	ALL	17.0 (0.669)	22.0 (0.866)	23.0 (0.906)	29.0 (1.102)	17.0 (0.669)	22.0 (0.866)	23.0 (0.906)	29.0 (1.102)
Dia D	ALL	13.5 (0.531)	17.0 (0.669)	19.0 (0.748)	23.0 (0.906)	13.5 (0.531)	17.0 (0.669)	19.0 (0.748)	23.0 (0.906)
e	ALL	6.5 (0.256)	8.5 (0.335)	6.5 (0.256)	8.5 (0.335)	6.5 (0.256)	8.5 (0.335)	6.5 (0.256)	8.5 (0.335)
e1	115-175	1.5 (0.059)	4.0 (0.157)	1.5 (0.059)	4.0 (0.157)	1.5 (0.059)	4.0 (0.157)	1.5 (0.059)	4.0 (0.157)
	200-420	2.0 (0.079)	6.0 (0.236)	2.0 (0.079)	6.0 (0.236)	2.0 (0.079)	6.0 (0.236)	2.0 (0.079)	6.0 (0.236)
	460-750			0	2.0 (0.079)			0	2.0 (0.079)
e2	ALL					4.0 (0.138)	6.0 (0.236)	4.0 (0.157)	6.0 (0.236)
e3	ALL					0	2.0 (0.079)	0	2.0 (0.079)
E	115-175		9.0 (0.335)		9.0 (0.335)		9.0 (0.335)		9.0 (0.335)
	200-320		9.5 (0.374)		9.5 (0.374)		9.5 (0.374)		9.5 (0.374)
	385-460		11.0 (0.433)		11.0 (0.433)		11.0 (0.433)		11.0 (0.433)
	510-575				12.0 (0.472)				12.0 (0.472)
	625-750				13.0 (0.512)				13.0 (0.512)
L	ALL	25.4 (1.00)		25.4 (1.00)		25.4 (1.00)		25.4 (1.00)	
L3	ALL					6.0 (0.236)		6.0 (0.236)	
Dia b	115-420	0.76 (0.030)	0.86 (0.034)	0.76 (0.030)	0.86 (0.034)	0.76 (0.030)	0.86 (0.034)	0.76 (0.030)	0.86 (0.034)
	460-750			0.95 (0.037)	1.05 (0.041)			0.95 (0.037)	1.05 (0.041)
Dia c Outside Lead Only	ALL					0.76 (0.030)	0.86 (0.034)	0.76 (0.030)	0.86 (0.034)

For 14mm ratings above 420 Vrms contact factory for specifications.

Varistor Products

Thermally Protected

TMOV® and iTMOV® Varistor Series

Tape and Reel Specifications - Additional Option L2T7

SYMBOL	PARAMETER	MODEL SIZE	
		14mm	20mm
B ₁	Component Top to Seating Plane	21.50 ± 0.50	28.00 ± 0.50
P	Pitch of Component	25.4 ± 1.0	25.4 ± 1.0
P ₀	Feed Hole Pitch	12.7 ± 0.2	12.7 ± 0.2
P ₁	Feed Hole Center to Pitch	8.95 ± 0.7	8.95 ± 0.7
P ₂	Hole Center to Component Center	12.7 ± 0.7	12.7 ± 0.7
F	Lead to Lead Distance	7.5 ± 0.8	7.5 ± 0.8
Δh	Component Alignment	2.0 Max	2.0 Max
W	Tape Width	18.0 + 1.0 18.0 - 0.5	18.0 + 1.0 18.0 - 0.5
W ₀	Hold Down Tape Width	12.0 ± 0.3	12.0 ± 0.3
W ₁	Hole Position	9.0 + 0.75 9.0 - 0.50	9.0 + 0.75 9.0 - 0.50
W ₂	Hold Down Tape Position	0.5 Max	0.5 Max
H ₁	Component Height	40.0 Max	46.5 Max
D ₀	Feed Hole Diameter	4.0 ± 0.2	4.0 ± 0.2
t	Total Tape Thickness	0.7 ± 0.2	0.7 ± 0.2
L	Length of Clipped Lead	11.0 Max	11.0 Max
Δp	Component Alignment	3° Max, 1.00mm	3° Max
C	Crimp Length	2.6 typ	2.6 typ
H ₀	Seating Plane Height	16.0 ± 0.5	16.0 ± 0.5

Dimensions are in mm.

- Reel capacity varies with voltage.
- Leads are crimped and in-line.
- To order tape and reel option please add suffix L2T7 to end of standard part number.
- Tape and Reel option is available for rated voltages up to 420volts. Contact factory regarding availability of higher voltages.

Contact Littelfuse for additional details.

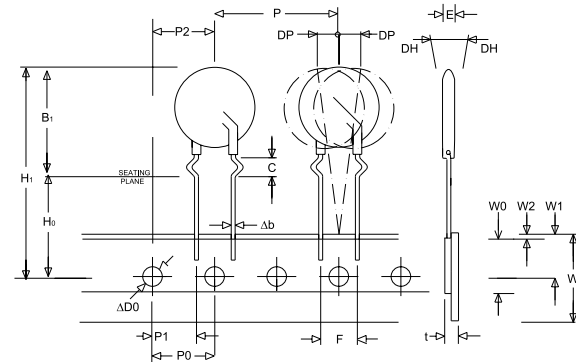

TMOV varistor with outer crimp

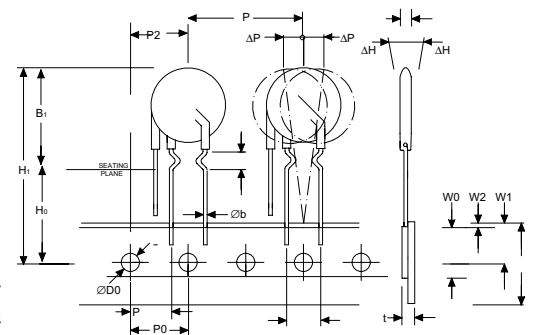

iTMOV varistor with inner crimp

Pack Quantities

Rated Voltage	Pack Quantities			
	Bulk Pack		Tape and Reel	
	Model Size		Model Size	
	14mm	20mm	14mm	20mm
115-250	600	400	500	400
275-550	500	300	400	300
575-750	400	200	n/a	n/a

NOTE: Tape and Reel available up to 420V only - please contact factory regarding availability of higher voltage parts.