

LOW CAPACITANCE TVS ARRAY
APPLICATIONS

- ✓ T1/E1
- ✓ RS-422, RS-423 & RS-485
- ✓ SDH/SONET, ATM Equipment & Systems
- ✓ Industrial Controls & Monitoring
- ✓ Cable Modem Intra-Building Protection

IEC COMPATIBILITY (EN61000-4)

- ✓ 61000-4-2 (ESD): Air - 15kV, Contact - 8kV
- ✓ 61000-4-4 (EFT): 40A - 5/50ns
- ✓ 61000-4-5 (Surge): 8/20 μ s - 95A, L4(Line-Gnd) & 48A, L4(Line-Line) & 83A, L2(Power)

FEATURES

- ✓ 3,600 Watts Peak Pulse Power per Line ($t_p=8/20\mu$ s)
- ✓ 600 Watts Peak Pulse Power per Line ($t_p=10/1000\mu$ s)
- ✓ 100A (2/10 μ s) per Bellcore GR-1089 (Intra-Building)
- ✓ Bidirectional Configuration
- ✓ High Surge Capability: 80A (10/1000 μ s)
- ✓ Available in 2 Voltages: 6.5V & 12V
- ✓ Protects Two (2) Bidirectional Lines
- ✓ **LOW CAPACITANCE: < 30pF per LINE PAIR**
- ✓ RoHS Compliant in Lead-Free Versions

MECHANICAL CHARACTERISTICS

- ✓ Molded JEDEC SO-16 Package
- ✓ Weight 0.15 grams (Approximate)
- ✓ Available in Tin-Lead or Lead-Free Pure-Tin Plating(Annealed)
- ✓ Solder Reflow Temperature:
 - Tin-Lead - Sn/Pb, 85/15: 240-245°C
 - Pure-Tin - Sn, 100: 260-270°C
- ✓ Flammability rating UL 94V-0
- ✓ 16mm Tape and Reel Per EIA Standard 481
- ✓ Marking: Logo, Part Number, Date Code & Pin One Defined By Dot on Top of Package

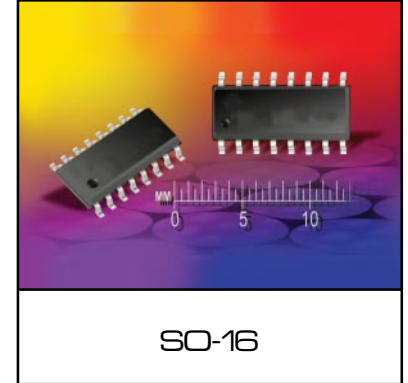
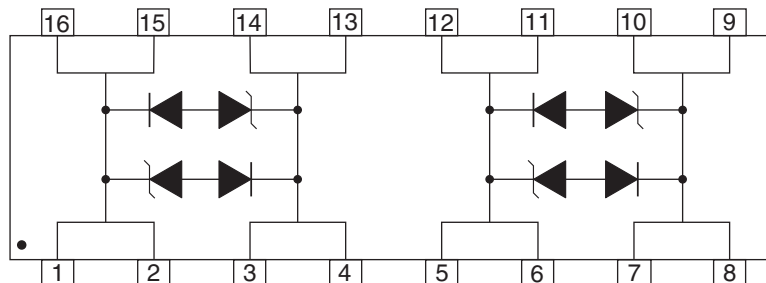

PIN CONFIGURATION

DEVICE CHARACTERISTICS

MAXIMUM RATINGS @ 25°C Unless Otherwise Specified			
PARAMETER	SYMBOL	VALUE	UNITS
Peak Pulse Power ($t_p = 8/20\mu s$)	P_{PP}	3,600	Watts
Peak Pulse Power ($t_p = 10/1000\mu s$) - See Figure 1	P_{PP}	600	Watts
Operating Temperature	T_J	-55°C to 150°C	°C
Storage Temperature	T_{STG}	-55°C to 150°C	°C

ELECTRICAL CHARACTERISTICS PER LINE @ 25°C Unless Otherwise Specified					
PART NUMBER	RATED STAND-OFF VOLTAGE V_{WM} VOLTS	MINIMUM BREAKDOWN VOLTAGE @ 1mA $V_{(BR)}$ VOLTS	MAXIMUM LEAKAGE CURRENT @ V_{WM} I_D μA	MAXIMUM CLAMPING VOLTAGE (See Fig. 2) @ $I_{PP} = 10A$ V_C VOLTS	TYPICAL CAPACITANCE @ 0V, 1MHz C pF
SMLC6.5C-2	6.5	7.2	300	12.4	30
SMLC12C-2	12.0	13.3	2	19.9	30

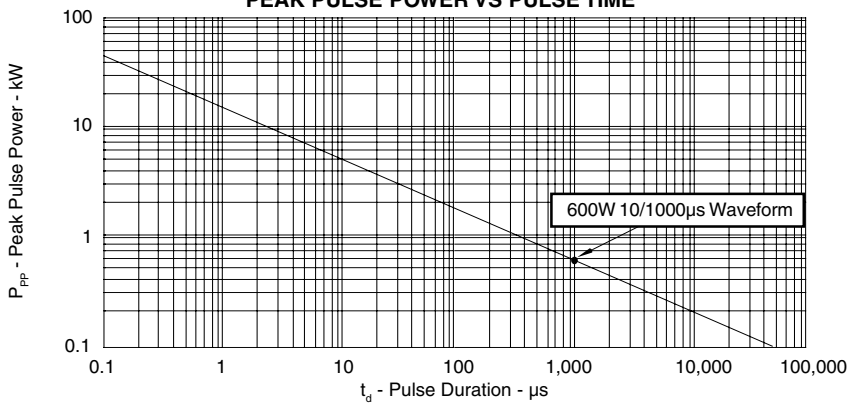
**FIGURE 1
 PEAK PULSE POWER VS PULSE TIME**



**FIGURE 2
 PULSE WAVE FORM**

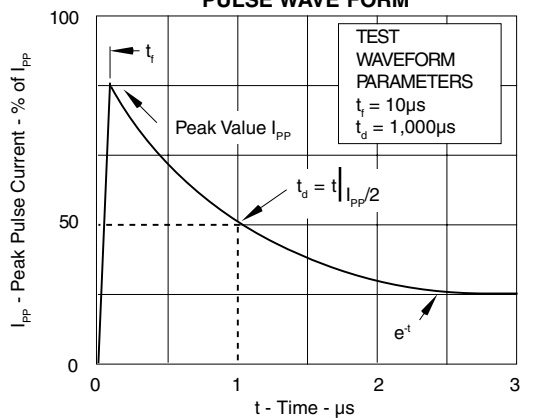

GRAPHS

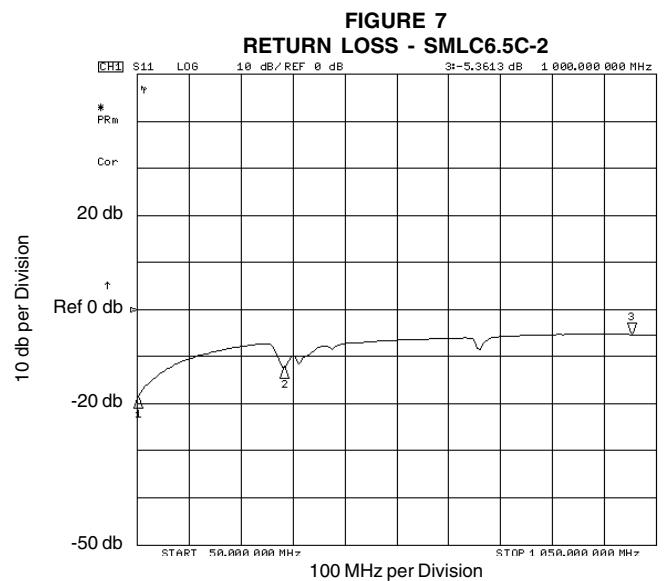
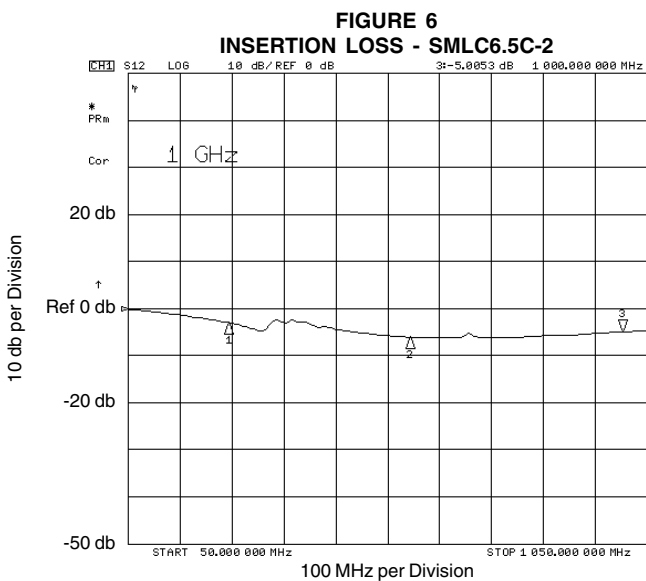
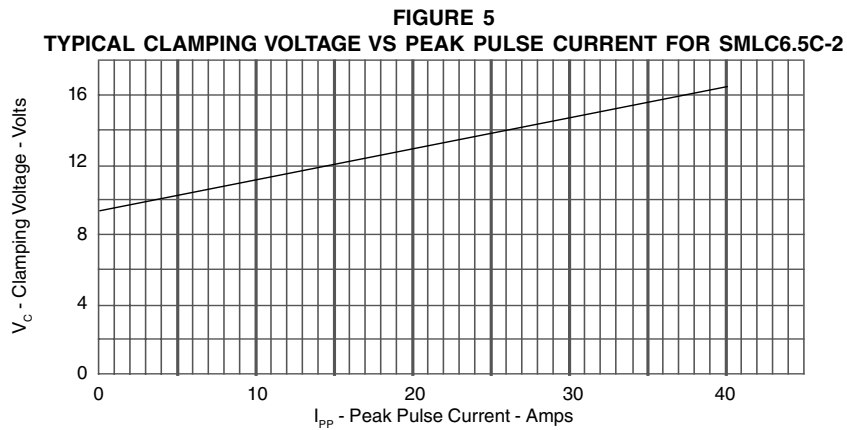
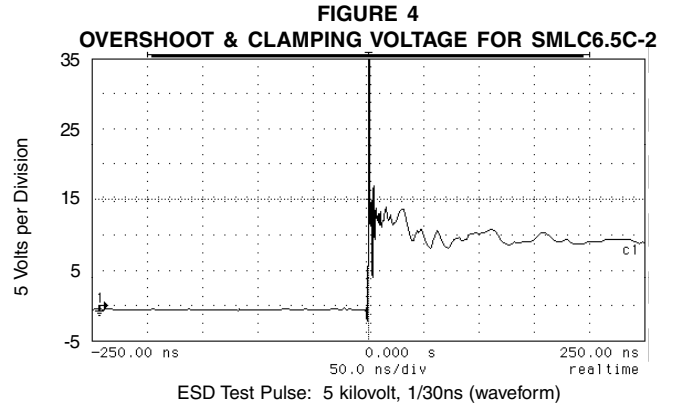
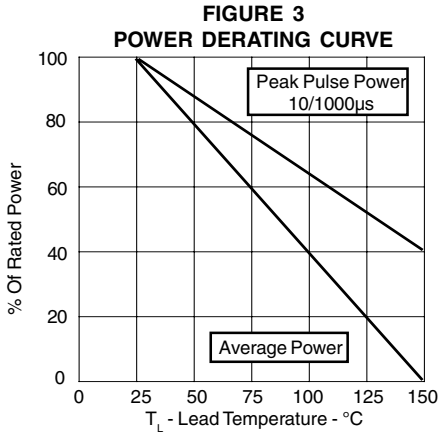

APPLICATION NOTE

The SMLCxxC-2 Series are low capacitance, bidirectional TVS arrays that are designed to protect I/O or high speed data lines from the damaging effects of ESD or EFT. This product series has a surge capability of 600 Watts P_{pp} per line for an 10/1000 μ s waveform and ESD protection > 40kV.

BIDIRECTIONAL DIFFERENTIAL-MODE CONFIGURATION(Figure 1)

Ideal for use multimode transceiver I/O lines, telecommunications and wireless circuits, the SMLCxxC-2 Series provides up to two (2) line pairs of protection in a differential-mode T1/E1 application as depicted in Figure 1.

Circuit connectivity is as follows:

- ✓ Line 1 is connected to Pins 1, 2, 15 & 16.
- ✓ Line 2 is connected to Pins 3, 4, 13 & 14.
- ✓ Line 3 is connected to Pins 5, 6, 11, & 12.
- ✓ Line 4 is connected to Pins 7, 8, 9 & 10.

CIRCUIT BOARD LAYOUT RECOMMENDATIONS

Circuit board layout is critical for Electromagnetic Compatibility (EMC) protection. The following guidelines are recommended:

- ✓ The protection device should be placed near the input terminals or connectors, the device will divert the transient current immediately before it can be coupled into the nearby traces.
- ✓ The path length between the TVS device and the protected line should be minimized.
- ✓ All conductive loops including power and ground loops should be minimized.
- ✓ The transient current return path to ground should be kept as short as possible to reduce parasitic inductance.
- ✓ Ground planes should be used whenever possible. For multilayer PCBs, use ground vias.

Figure 1. Differential-Mode Protection For T1/E1 Applications

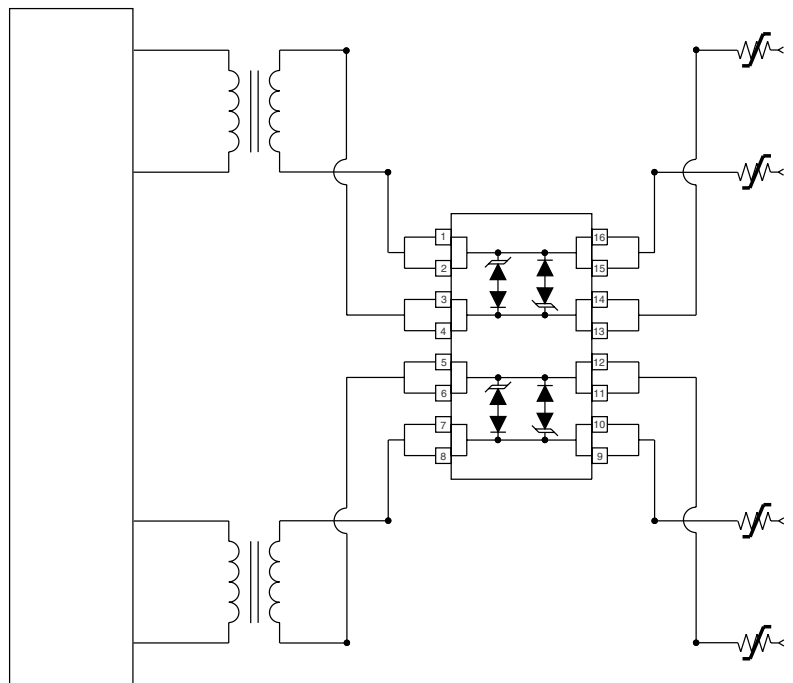

PACKAGE OUTLINE & DIMENSIONS

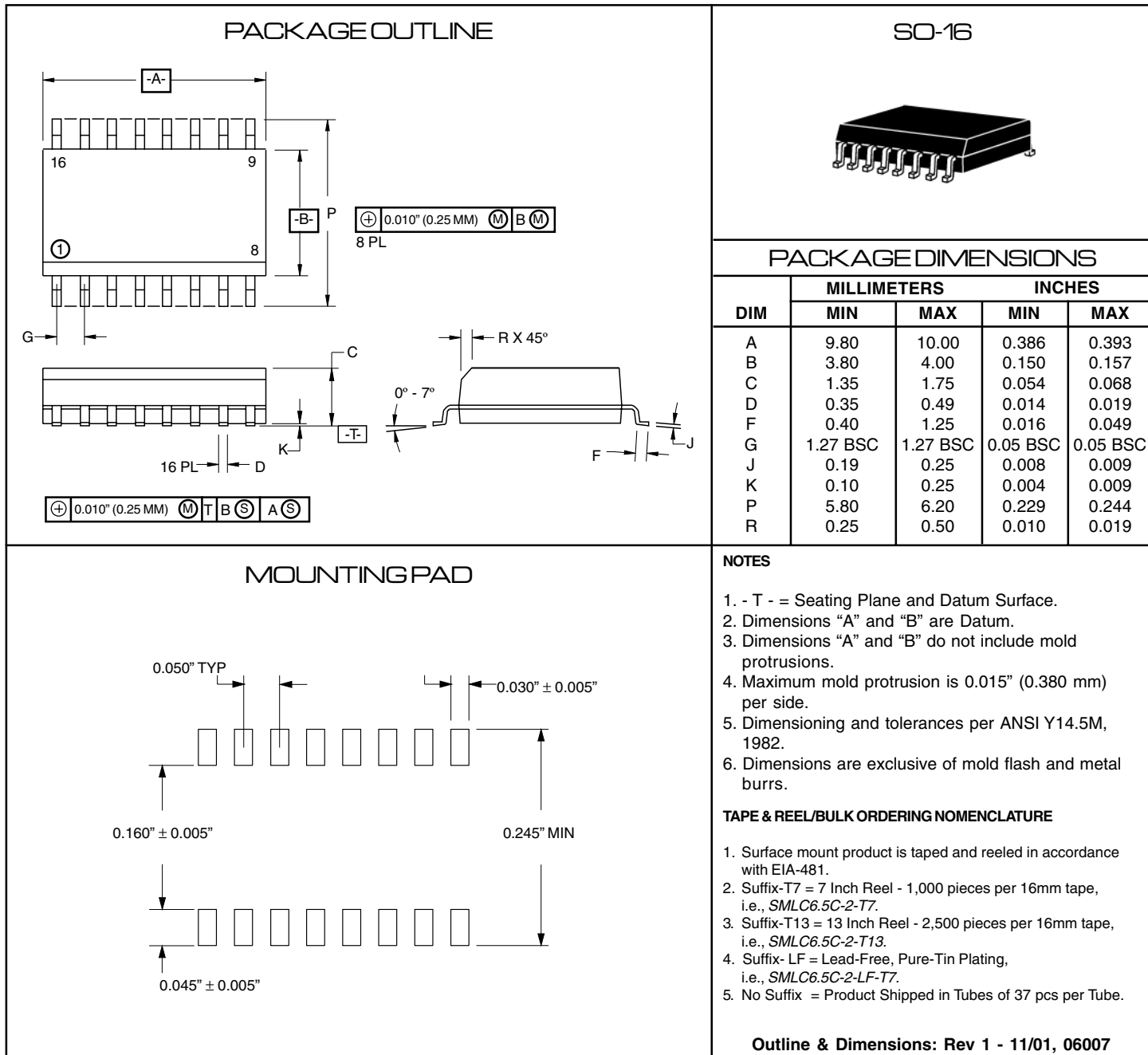

COPYRIGHT © ProTek Devices 2005

SPECIFICATIONS: ProTek reserves the right to change the electrical and or mechanical characteristics described herein without notice (except JEDEC).

DESIGN CHANGES: ProTek reserves the right to discontinue product lines without notice, and that the final judgement concerning selection and specifications is the buyer's and that in furnishing engineering and technical assistance, ProTek assumes no responsibility with respect to the selection or specifications of such products.

ProTek Devices
 2929 South Fair Lane, Tempe, AZ 85282
 Tel: 602-431-8101 Fax: 602-431-2288
 E-Mail: sales@protekdevices.com
 Web Site: www.protekdevices.com