

**Features**

- Colorless diffusion lens type
- Compact type
- Radiation size 1.3mm × 2.9mm
- Surface mount lead configuration

**Outline Dimensions**

**unit : mm**

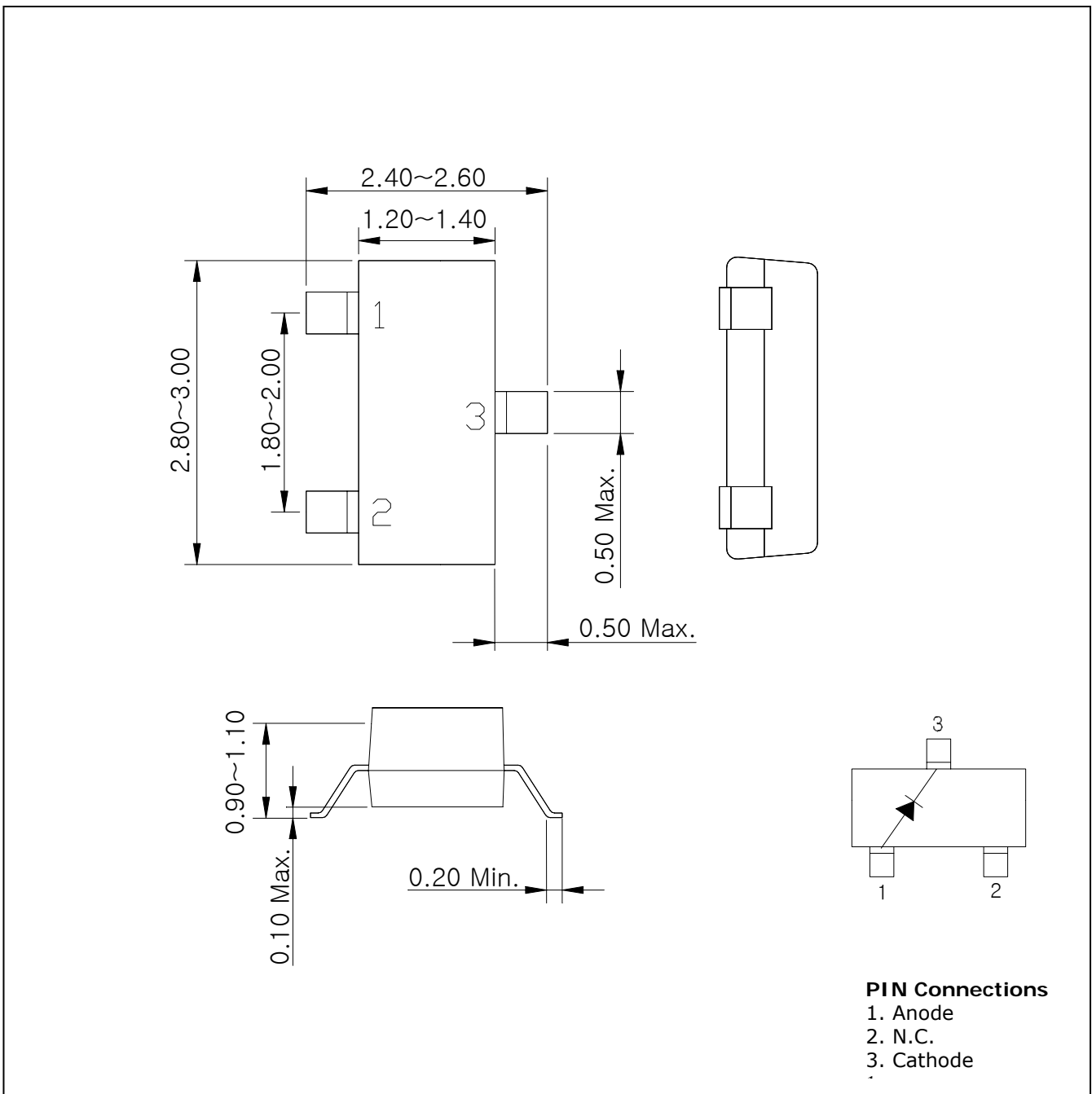

**Absolute Maximum Ratings**

(Ta=25°C)

| Characteristic              | Symbol           | Rating               | Unit |
|-----------------------------|------------------|----------------------|------|
| Power dissipation           | P <sub>D</sub>   | 63                   | mW   |
| Forward current             | I <sub>F</sub>   | 25                   | mA   |
| *1 Peak forward current     | I <sub>FP</sub>  | 50                   | mA   |
| Reverse voltage             | V <sub>R</sub>   | 4                    | V    |
| Operating temperature range | T <sub>opr</sub> | -25~80               | °C   |
| Storage temperature range   | T <sub>stg</sub> | -30~100              | °C   |
| *2 Soldering temperature    | T <sub>sol</sub> | 240°C for 10 seconds |      |

\*1. Duty ratio = 1/16, Pulse width = 0.1ms

\*2. Recommended reflow soldering temperature profile

- Preheating 150°C to 185°C within 120 seconds soldering 240°C within 10 seconds
- Gradual cooling (Avoid quenching)

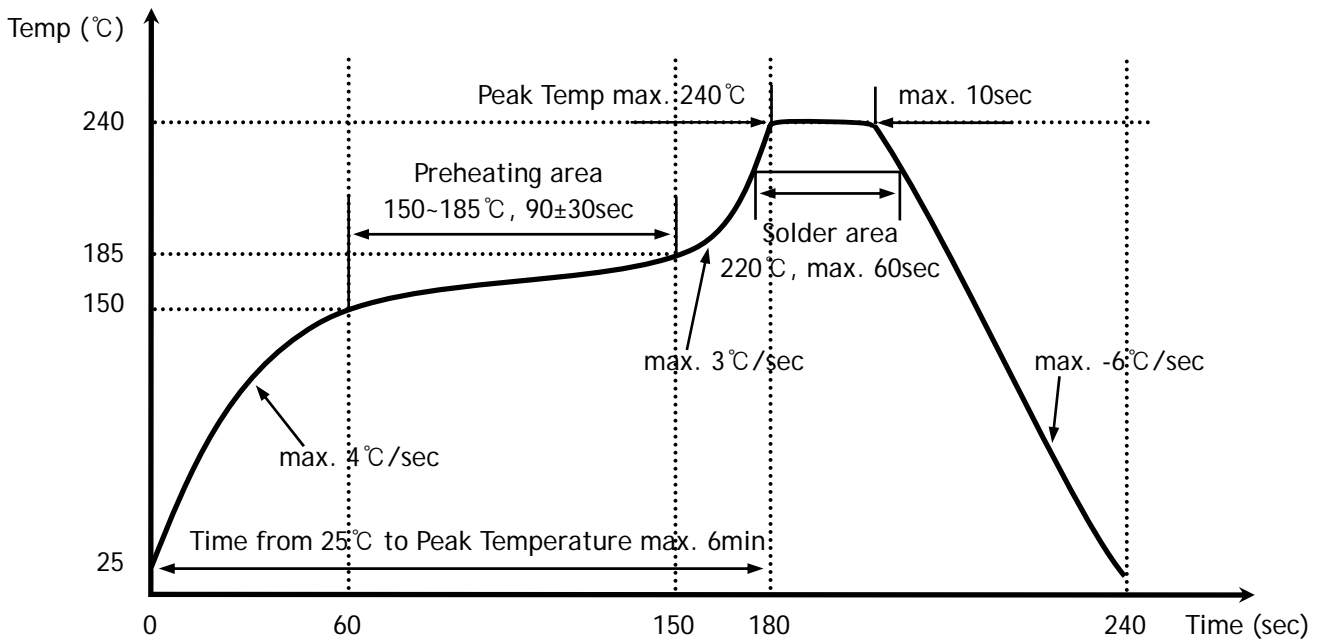

**Electrical / Optical Characteristics**

(Ta=25°C)

| Characteristic     | Symbol         | Test Condition        | Min | Typ. | Max. | Unit |
|--------------------|----------------|-----------------------|-----|------|------|------|
| Forward voltage    | V <sub>F</sub> | I <sub>F</sub> = 20mA | -   | 2.1  | 2.5  | V    |
| Luminous intensity | I <sub>V</sub> | I <sub>F</sub> = 20mA | 4   | -    | -    | mcd  |
| Peak wavelength    | λ <sub>P</sub> | I <sub>F</sub> = 20mA | -   | 570  | -    | nm   |
| Spectrum bandwidth | Δλ             | I <sub>F</sub> = 20mA | -   | 30   | -    | nm   |
| Reverse current    | I <sub>R</sub> | V <sub>R</sub> =4V    | -   | -    | 10   | uA   |
| *3 Half angle      | θ1/2           | I <sub>F</sub> = 20mA | -   | ±55  | -    | deg  |
|                    |                |                       | -   | ±80  | -    |      |

\*3. θ1/2 is the off-axis angle where the luminous intensity is 1/2 the peak intensity

Characteristic Diagrams

Fig. 1  $I_F - V_F$

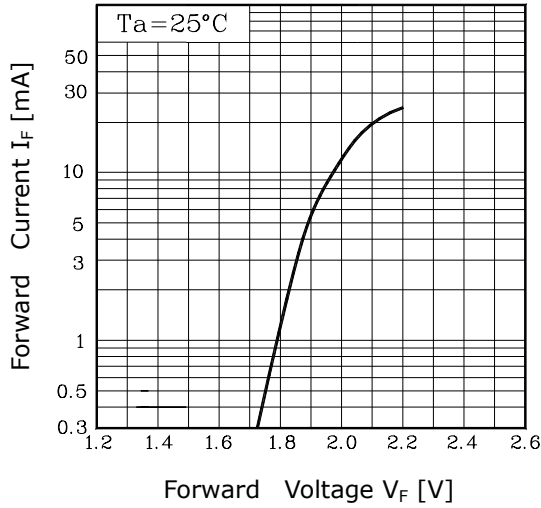

Fig. 2  $I_V - I_F$

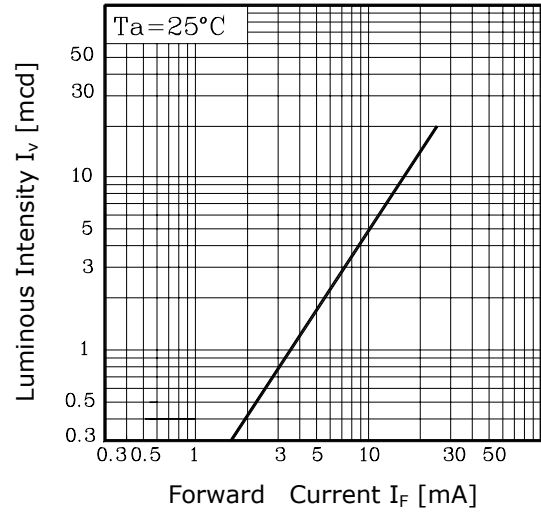

Fig. 3  $I_F - T_a$

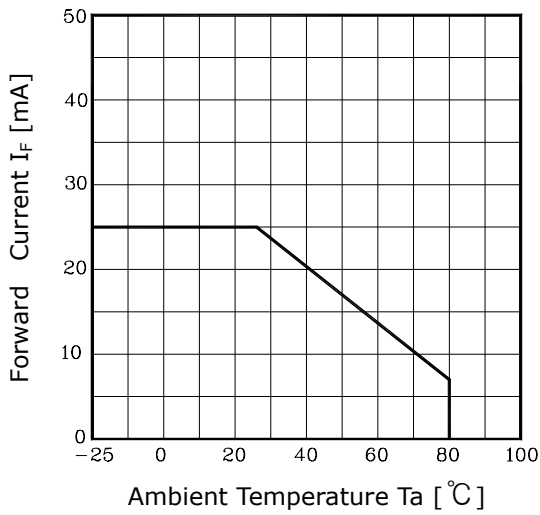

Fig.4 Spectrum Distribution

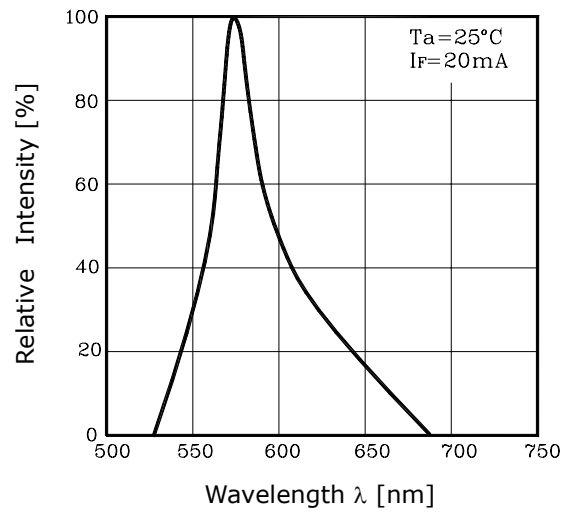

Fig. 5-1 Radiation Diagram(X)

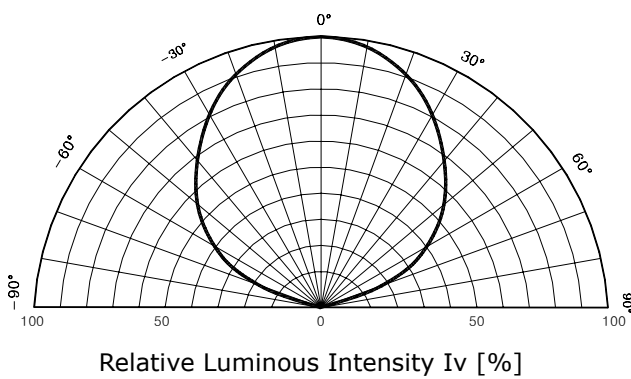
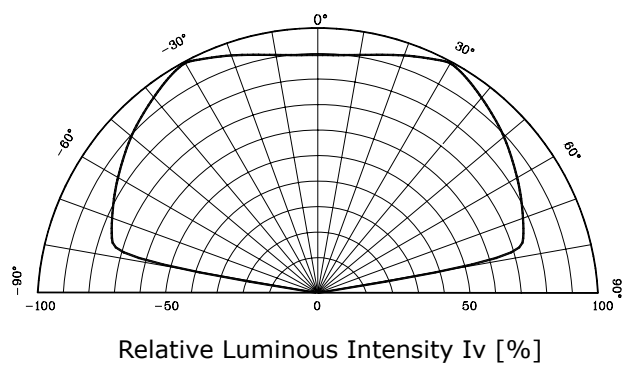

Fig. 5 Radiation Diagram



**The AUK Corp. products are intended for the use as components in general electronic equipment (Office and communication equipment, measuring equipment, home appliance, etc.).**

**Please make sure that you consult with us before you use these AUK Corp. products in equipments which require high quality and / or reliability, and in equipments which could have major impact to the welfare of human life(atomic energy control, airplane, spaceship, transportation, combustion control, all types of safety device, etc.). AUK Corp. cannot accept liability to any damage which may occur in case these AUK Corp. products were used in the mentioned equipments without prior consultation with AUK Corp..**

**Specifications mentioned in this publication are subject to change without notice.**