

# MONOCHIP THREE PHASE BIDIRECTIONAL KILOWATT HOUR METERING IC

## FEATURES

- Performs bidirectional energy metering and directly drives a LCD with 7 digits plus annunciators
- 4 externally selectable on-chip tariff registers
- An additional total energy register
- Meets the IEC 521/1036 Specification requirements for Class 1 AC Watt hour meters
- Optical interface for electronic reading according to IEC1107 Mode D
- Pulse output for calibration
- Total power consumption rating below 40mW
- Adaptable to different types of current sensors
- Operates over a wide temperature range
- Precision voltage reference on-chip
- Protected against ESD

## DESCRIPTION

The SAMES SA9110A Three Phase bidirectional energy metering integrated circuit has an integrated Liquid Crystal Display (LCD) driver for a 7 digit (7 segment) display as well as 4 multiple tariff registers. The SA9110A performs the active power calculation.

The method of calculation takes the power factor into account.

The measured energy is displayed in kilo Watt hours (kWh). The SA9110A is capable of driving a display having a resolution of 1/10 kWh.

This innovative universal energy metering integrated circuit is ideally suited for energy measurement in three phase systems.

The SA9110A integrated circuit is available in a 68 pin plastic leaded chip carrier (PLCC-68) package type.

## PIN CONNECTIONS

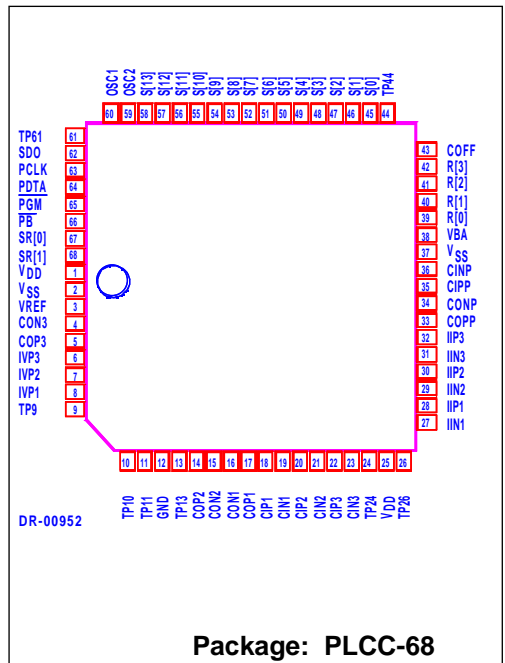

**BLOCK DIAGRAM**

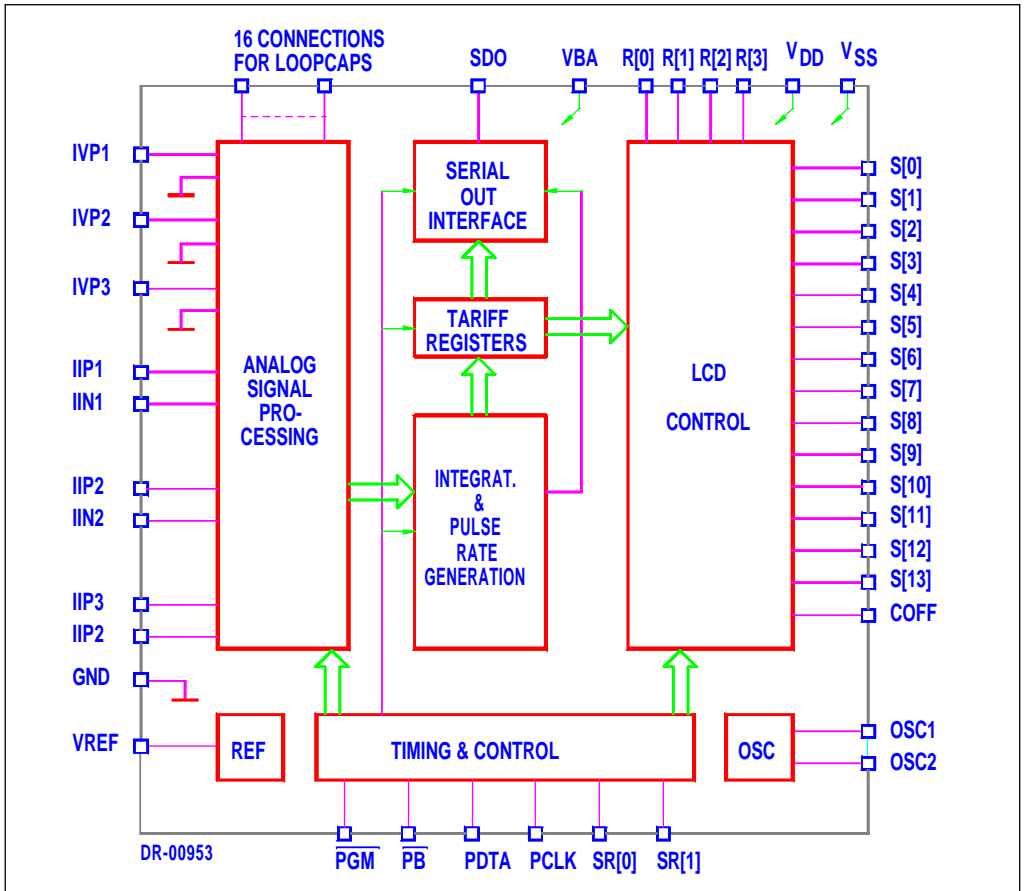

**ABSOLUTE MAXIMUM RATINGS\***

| Parameter             | Symbol            | Min  | Max  | Unit |
|-----------------------|-------------------|------|------|------|
| Supply Voltage        | $V_{DD} - V_{SS}$ | -0.3 | 6.0  | V    |
| Current on any pin    | $I_{PIN}$         | -150 | +150 | mA   |
| Storage Temperature   | $T_{STG}$         | -40  | +125 | °C   |
| Operating Temperature | $T_O$             | -10  | +70  | °C   |

\* Stresses above those listed under "Absolute Maximum Ratings" may cause permanent damage to the device. This is a stress rating only. Functional operation of the device at these or any other condition above those indicated in the operational sections of this specification, is not implied. Exposure to Absolute Maximum Ratings for extended periods may affect device reliability.

**ELECTRICAL CHARACTERISTICS**

(Over the temperature range -10°C to +70°C#, unless otherwise specified.)

| Parameter  | Symbol   | Min          | Typ                          | Max          | Unit              | Condition  |
|--|--|--------------|------------------------------|--------------|-------------------|--|
| Supply Voltage   | $V_{DD} - V_{SS}$  | 4.5          |                              | 5.5          | V                 |  |
| Supply Current   | $I_{DD}$   |              |                              | 15           | mA                |  |
| Nonlinearity of power calculation  |  | -0.3         |                              | +0.3         | %                 | 1% - 100% of rated power   |
| Current Sensor Inputs (Differential)   |  |              |                              |              |                   |  |
| Input Current Range  | $I_{II}$   | -25          |                              | +25          | $\mu$ A           | Peak value   |
| Voltage Sensor Inputs (Asymmetric)   |  |              |                              |              |                   |  |
| Input current Range  | $I_{IV}$   | -25          |                              | +25          | $\mu$ A           | Peak value   |
| LCD backplane Voltage  | $V_B$  |              | $V_{DD}$ &<br>$V_{SS}$       |              | V                 | R[0] .. R[3]   |
| LCD segment Voltage  | $V_S$  |              | $1/3 V_{DD}$<br>$2/3 V_{DD}$ |              | V                 | S[0] .. S[15]  |
| Pin SDO<br>Pulse rate  | $f_P$  |              | 3.5                          |              | Hz                | Default <sup>1</sup><br>Programmed <sup>1</sup>                                |
| Output Voltage Low   | $V_{OL}$   |              |                              | $V_{SS} + 1$ | V                 | $I_{OL} = 5\text{mA}$  |
| Output Voltage High  | $V_{OH}$   | $V_{DD} - 1$ |                              |              | V                 | $I_{OH} = -2\text{mA}$   |
| Oscillator   | Recommended crystal:<br>TV colour burst crystal $f = 3.5795$ MHz |              |                              |              |                   |  |
| Pin VREF<br>Ref. Current<br>Ref. Voltage   | $-I_R$<br>$V_R$  | 45<br>1.1    | 50                           | 55<br>1.3    | $\mu$ A<br>V      | With $R_7 = 24\text{k}\Omega$<br>connected to $V_{SS}$<br>Referred to $V_{SS}$ |
| Pins $\overline{PB}$ , SR[0], SR[1],<br>PGM<br>Input Voltage High<br>Input Voltage Low<br>Pullup Current | $V_{IH}$<br>$V_{IL}$   | 4            |                              | 1            | V<br>V<br>$\mu$ A | $V_{IN} = V_{SS}$  |
| Pin PCLK<br>Input Voltage High<br>Input Voltage Low<br>Input Current High/<br>Low                        | $V_{IH}$<br>$V_{IL}$   | 4            |                              | 1            | V<br>V<br>$\mu$ A | $V_{IN} = V_{SS} \cdot V_{DD}$   |
| Pin $V_{BA}$   | $I_{MAX}$<br>$V_{MIN}$   | 1.1          |                              | 50           | nA<br>V           | Power down mode  |

# Extended Operating Temperature Range available on request

Note 1: At rated conditions



## PIN DESCRIPTION

| Pin | Designation     | Type      | Description   |
|-----|-----------------|-----------|---|
| 12  | GND             | Supply    | Ground  |
| 1   | V <sub>DD</sub> | Supply    | Positive Supply Voltage   |
| 25  | V <sub>DD</sub> | Supply    |   |
| 2   | V <sub>SS</sub> | Supply    |   |
| 37  | V <sub>SS</sub> | Supply    | Negative Supply Voltage   |
| 38  | VBA             | Supply    |   |
| 8   | IVP1            | Analog in | Input for voltage sense : Phase 1   |
| 7   | IVP2            | Analog in | Input for voltage sense : Phase 2   |
| 6   | IVP3            | Analog in | Input for voltage sense : Phase 3   |
| 27  | IIN1            | Analog in | Inputs for current sensor : Phase 1   |
| 28  | IIP1            | Analog in |   |
| 29  | IIN2            | Analog in |   |
| 30  | IIP2            | Analog in | Inputs for current sensor : Phase 2   |
| 31  | IIN3            | Analog in |   |
| 32  | IIP3            | Analog in | Inputs for current sensor : Phase 3   |
| 60  | OSC1            | Input     | Connections for crystal or ceramic resonator<br>(OSC1 = Input; OSC2 = Output) |
| 59  | OSC2            | Output    |   |
| 39  | R[0]            | Output    | Liquid crystal display (LCD) backplane drivers                                |
| 40  | R[1]            | Output    |   |
| 41  | R[2]            | Output    |   |
| 42  | R[3]            | Output    |   |
| 45  | S[0]            | Output    |   |
| 46  | S[1]            | Output    | Liquid crystal display (LCD) segment drivers                                  |
| 47  | S[2]            | Output    |   |
| 48  | S[3]            | Output    |   |
| 49  | S[4]            | Output    |   |
| 50  | S[5]            | Output    |   |
| 51  | S[6]            | Output    |   |
| 52  | S[7]            | Output    |   |
| 53  | S[8]            | Output    |   |
| 54  | S[9]            | Output    |   |
| 55  | S[10]           | Output    |   |
| 56  | S[11]           | Output    |   |
| 57  | S[12]           | Output    |   |
| 58  | S[13]           | Output    |   |
| 43  | COFF            | Output    | Connection for all unused LCD segments, to ensure off status                  |

## PIN DESCRIPTION (continued)

| Pin | Designation     | Type       | Description   |
|-----|-----------------|------------|---|
| 16  | CON1            | Analog     | Connections for outer loop capacitors of A/D converters   |
| 17  | COP1            | Analog     |   |
| 15  | CON2            | Analog     |   |
| 14  | COP2            | Analog     |   |
| 4   | CON3            | Analog     |   |
| 5   | COP3            | Analog     |   |
| 34  | CONP            | Analog     |   |
| 33  | COPP            | Analog     |   |
| 19  | CIN1            | Analog     | Connections for inner loop capacitors of A/D converters   |
| 18  | CIP1            | Analog     |   |
| 21  | CIN2            | Analog     |   |
| 20  | CIP2            | Analog     |   |
| 23  | CIN3            | Analog     |   |
| 22  | CIP3            | Analog     |   |
| 36  | CINP            | Analog     |   |
| 35  | CIPP            | Analog     |   |
| 3   | VREF            | Analog     | Connection for reference current setting resistor   |
| 62  | SDO             | Open drain | Pulse rate output. Serial data output when $\overline{PB}$ is low   |
| 67  | SR[0]           | Input      | Control for tariff register selection (on-chip pull-up)   |
| 68  | SR[1]           | Input      | Control for tariff register selection (on-chip pull-up)   |
| 66  | $\overline{PB}$ | Input      | Push Button: Display select/start serial data transmission on SDO (on-chip pull-up)   |
| 65  | PGM             | Input      | Programming Mode . It is recommended that pin PGM be connected to VDD via a 470 $\Omega$ resistor to guard against transients or noise. |
| 64  | PDTA            | Input      | Programming Data (on-chip pull-down)  |
| 63  | PCLK            | Input      | Programming Clock   |
| 9   | TP9             |            | Manufacturer's test pins (Leave unconnected)  |
| 10  | TP10            |            |   |
| 11  | TP11            |            |   |
| 13  | TP13            |            |   |
| 24  | TP24            |            |   |
| 26  | TP26            |            |   |
| 44  | TP44            |            |   |
| 61  | TP61            |            |   |

## FUNCTIONAL DESCRIPTION

The SA9110A is a CMOS mixed signal Analog/Digital integrated circuit, which performs three phase energy calculations across a power range of 1000:1, to an overall accuracy of better than Class 1. An on-chip LCD driver directly drives a 7 digit (7 segment) LCD. Also included on-chip, are 4 x tariff registers externally selectable for multi-tariff energy metering applications and a fifth register which retains the total energy consumption.

The integrated circuit includes all the required functions such as two oversampling A/D converters for the voltage and current sense inputs, power calculation and energy integration. Offset is eliminated through the use of internal cancellation procedures.

### 1. Power Calculation

In the Application Circuit (Figure 1), the mains voltage from Line 1, Line 2 and Line 3, are converted to currents and applied to the voltage sense inputs IVP1, IVP2 and IVP3.

The current levels on the voltage sense inputs are derived from the mains voltage (3 x 230 VAC) being divided down through voltage dividers to 14V. The resulting input currents into the A/D converters are 14 $\mu$ A through the resistors R<sub>15</sub>, R<sub>16</sub> and R<sub>17</sub>.

For the current sense inputs the voltage drop across the current transformers terminating resistors are converted to currents of 16 $\mu$ A for rated conditions, by means of resistors R<sub>8</sub>, R<sub>9</sub> (Phase 1); R<sub>10</sub>, R<sub>11</sub> (Phase 2) and R<sub>12</sub>, R<sub>13</sub> (Phase 3).

The signals providing the current information are applied to the current sensor inputs IIN1, IIP1, IIN2, IIP2 and IIN3, IIP3.

A pulse rate output for calibration purposes is available on SDO (Pin 62), the pulse rate being proportional to the active energy consumption.

The integrated anti-creep function ensures no metering when no line current is present.

### 2. Analog Input Configuration

The input circuitry of the current and voltage sensor inputs are illustrated below.

These inputs are protected against electrostatic discharge through clamping diodes.

The feedback loops from the outputs of the amplifiers A<sub>i</sub> and A<sub>v</sub> generate virtual shorts on the signal inputs. Exact duplications of the input currents are generated for the analog signal processing circuitry.

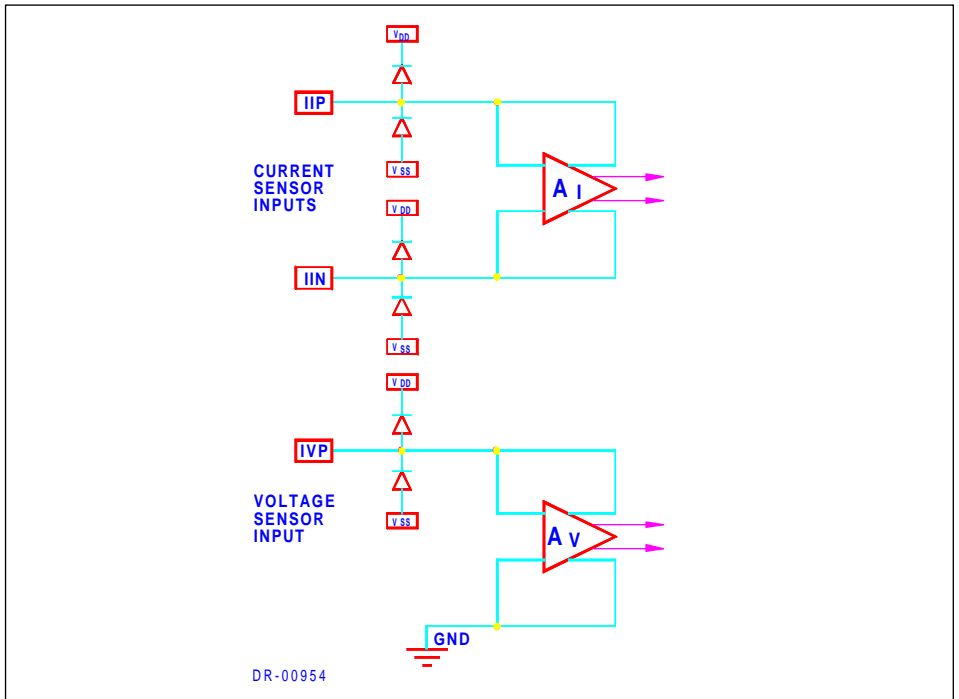

### 3. LCD Driver

The SA9110A has an on-chip LCD driver capable of driving a 4 backplane, 7 digit (7 segment) display, as well as 6 annunciators.

The backplane repetition frequency is approximately 90Hz.

The most significant digit is addressed by columns S[13] and S[12] and the least significant digit by S[1] and S[0]. Annunciators for the total register, 4 tariff registers and energy direction indication are available on the 'h' segments of the 6 least significant digits. The display segments are addressed via the column outputs given in the table below:

**LCD Segment Address Table**

| Digit                   | Column | R[0]  | R[1] | R[2] | R[3] |
|-------------------------|--------|-------|------|------|------|
| 10 <sup>-1</sup><br>LSD | S[0]   | Total | c    | b    | a    |
|                         | S[1]   | d     | e    | g    | f    |
| 10 <sup>0</sup>         | S[2]   | T4    | c    | b    | a    |
|                         | S[3]   | d     | e    | g    | f    |
| 10 <sup>1</sup>         | S[4]   | T3    | c    | b    | a    |
|                         | S[5]   | d     | e    | g    | f    |
| 10 <sup>2</sup>         | S[6]   | T2    | c    | b    | a    |
|                         | S[7]   | d     | e    | g    | f    |
| 10 <sup>3</sup>         | S[8]   | T1    | c    | b    | a    |
|                         | S[9]   | d     | e    | g    | f    |
| 10 <sup>4</sup>         | S[10]  | Dir   | c    | b    | a    |
|                         | S[11]  | d     | e    | g    | f    |
| 10 <sup>5</sup><br>MSD  | S[12]  | h     | c    | b    | a    |
|                         | S[13]  | d     | e    | g    | f    |

**LCD Layout**

The LCD display is given in the diagram below:

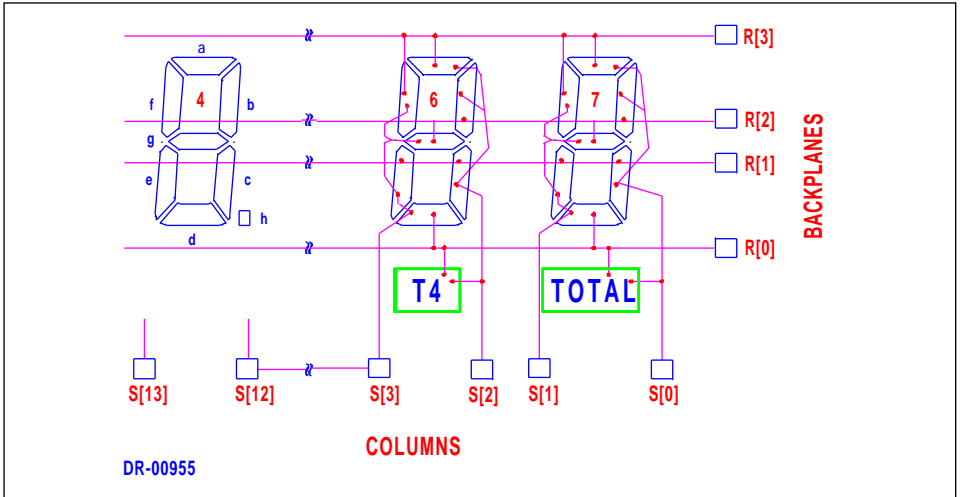

The kWh values of the LCD display digits, are given in the table below. The resolution of the Least Significant Digit is normally programmed to 0.1kWh:

|                 |                 |                 |                 |                 |                 |                  |     |
|-----------------|-----------------|-----------------|-----------------|-----------------|-----------------|------------------|-----|
| 10 <sup>5</sup> | 10 <sup>4</sup> | 10 <sup>3</sup> | 10 <sup>2</sup> | 10 <sup>1</sup> | 10 <sup>0</sup> | 10 <sup>-1</sup> | kWh |
|-----------------|-----------------|-----------------|-----------------|-----------------|-----------------|------------------|-----|



#### 4. Device Programming

The SA9110A contains on-chip registers which enables the meter manufacturer to store various data:

##### **Slope Adjustment**

The slope of the device may be adjusted by programming a slope constant ( $K_s$ ) into the device during calibration. The output frequency at SDO ( $f_p$ ) is calculated by means of the following formula:

$$f_p = 11.16 * \frac{\text{FOSC}}{3.5795\text{MHz}} * \frac{40062.5}{K_s} * \frac{(I_{I1} * I_{V1}) + (I_{I2} * I_{V2}) + (I_{I3} * I_{V3})}{3 * I_R^2}$$

Where

FOSC = Oscillator frequency (2MHz ..... 4MHz)

$I_{I1}, I_{I2}, I_{I3}$  = Input current for current sensor input (16 $\mu$ A at rated line current)

$I_{V1}, I_{V2}, I_{V3}$  = Input current for voltage sensor input (14 $\mu$ A at rated line voltage)

$I_R$  = Reference current (typically 50 $\mu$ A)

$K_s$  = Slope constant (1025 ... 16384)

(The default value is 11389)

By changing the slope of the device the resolution of the LCD together with the pulse rate on SDO may be changed by up to an order. The block diagram below illustrates the display update rate.

##### **Programmable slope divider**

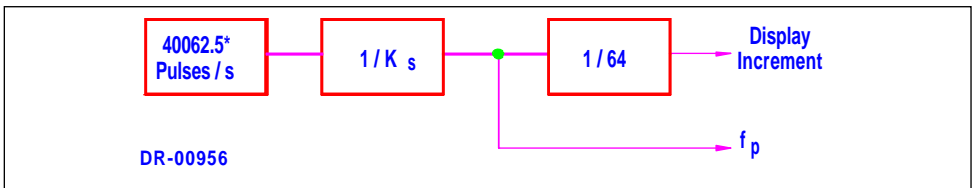

\* At rated conditions

The display is incremented after every 64th pulse on SDO.

##### **Display Resolution**

From the above formula for  $f_p$  it can be derived that the slope constant,  $K_s$ , is given by the following expression:-

$$K_s = (626 * 3600 * 1000 * E_{kWh}) / (3 * V_L * I_L)$$

Where  $E_{kWh}$  = energy for 1 Display increment in kWh

$V_L$  = rated line voltage

$I_L$  = rated line current

This formula is valid only if 16 $\mu$ A flows into each of the current sense inputs for rated line current ( $I_L$ ) and 14 $\mu$ A flows into the voltage sense inputs for rated line voltage ( $V_L$ ).



### Offset Adjustment

The precision of this device does not require any offset adjustment for Class 1 metering. This facility has been provided to compensate for poor PCB layout or circumstances requiring precision well beyond a Class 1 rating.

The offset of the device may be adjusted by programming a different offset into the device during calibration. To calculate the offset the following procedure should be followed:

Measure the linearity error at the current where offset correction is needed.

$$K_O = \frac{I_M * E_{RR}}{I_R * 6 * 10^{-6}}$$

Where

- $I_M$  = Measured current on the current sensor
- $I_R$  = Rated current on the current sensor
- $E_{RR}$  = Error ratio between the device and the Wh standard
- $K_O$  = Offset constant (-127 ... 127)

Note that  $K_O$  must be programmed as a integer value.

### Meter/Manufacturers Identification Data

A total of eleven 4 bit words are available to store relevant data such as the meter and manufacturer identification codes. For the optical interface protocol, the 4-bit words are converted to 8-bit words (ASCII-format).

### Writing to RAM

The memory is configured as ten 32 bit words. The programming data must be written to the device as a bitstream containing a total of 320 bits. ROM-locations will not be overwritten.

| Word number | Bit number | Function                 | Description                                    |
|-------------|------------|--------------------------|--|
| 1           | 31..28     | Sign of Register 1       | A '1' indicates a negative register value      |
| 1           | 27..0      | Register 1               | Contents of register 1 in binary coded decimal |
| 2           | 31..28     | Sign of Register 2       | A '1' indicates a negative register value      |
| 2           | 27..0      | Register 2               | Contents of register 2 in binary coded decimal |
| 3           | 31..28     | Sign of Register 3       | A '1' indicates a negative register value      |
| 3           | 27..0      | Register 3               | Contents of register 3 in binary coded decimal |
| 4           | 31..28     | Sign of Register 4       | A '1' indicates a negative register value      |
| 4           | 27..0      | Register 4               | Contents of register 4 in binary coded decimal |
| 5           | 31..28     | Sign of Register 'Total' | A '1' indicates a negative register value      |

| Word number | Bit number | Function                     | Description  |
|-------------|------------|------------------------------|--|
| 5           | 27..0      | Register 'Total'             | Registers 1, 2, 3 and 4 are added and stored in the register 'Total'                         |
| 6           | 31..16     | ROM                          | Don't care   |
| 6           | 15..0      | Manufacturers Identification | 16 bits are available for the manufacturer of the metering system as a system identification |
| 7           | 31..28     | ROM                          | Don't care   |
| 7           | 27..0      | System Identification        | 28 bits are available for the manufacturer of the metering system as a system identification |
| 8           | 31..0      | ROM                          | Don't care   |
| 9           | 31         | Programmed slope select      | Programmed slope select bit must be set if the default slope in ROM is not used              |
| 9           | 30..25     | ROM                          | Don't care   |
| 9           | 24-22      | SAMES defined register       | Bits must be set to 0 for correct functionality  |
| 9           | 21         | Sign of offset               | By setting the sign bit a negative value is indicated  |
| 9           | 20..14     | Offset                       | Offset of the device in binary   |
| 9           | 13         | Sign of slope                | By setting the sign bit a negative value is indicated  |
| 9           | 12..0      | Slope                        | Slope of the device in binary. (default = 11389)   |
| 10          | 31..0      | ROM                          | Don't care   |

The first bit of the programming data is written to word number 1, bit 31. The last bit is written to word number 10, bit 0.

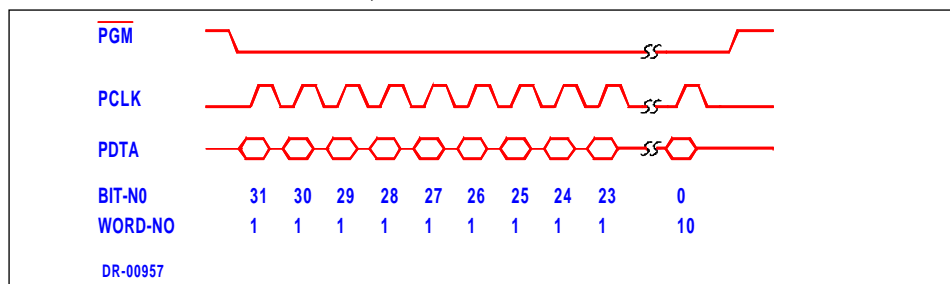

### Programming procedure:

The PGM pin is pulled low and the PCLK pin should be clocked with an external clock. The programming data on the PDTA pin must be stable during the rising edge of the clock signal on PCLK.

The clock signal on PCLK should not exceed 200 kHz and does not have to be synchronised with the oscillator frequency (FOSC).

Programming mode is interrupted if  $\overline{\text{PGM}}$  goes high.



## Memory Reset

In programming mode (while  $\overline{\text{PGM}}$  is pulled low) if PCLK is left floating and PDTA=0, the internal clock of the SA9110A will ensure that default values are set. For default conditions all of the RAM locations are set to 0 and the value of the slope is set to 11389.

The minimum time period for a complete reset cycle is determined by:

$$t_{\min} = 322 * \frac{64}{\text{FOSC}}$$

Where FOSC = Oscillator frequency (2MHz.....4MHz)

If the recommended crystal frequency of 3.5795MHz is used, this will result in a minimum reset time of 5.8ms.

The specified signal levels on pins  $\overline{\text{PGM}}$ , PCLK and PDTA must remain stable for the entire reset cycle period.

## 5. Tariff Registers

A multiple tariff facility is provided on-chip by means of 4 tariff registers, which are externally selectable via the SR[0] and SR[1] inputs. The registers may be selected by programming the SR[0] and SR[1] inputs as follows:

| SR[1] | SR[0] | Register   |
|-------|-------|------------|
| 0     | 0     | Register 1 |
| 0     | 1     | Register 2 |
| 1     | 0     | Register 3 |
| 1     | 1     | Register 4 |

The 4 tariff registers as well as the total register may be sequentially displayed by activating the Push Button (PB). The minimum Push Button make time is 5mS. The contents of the register selected for display is retained on the display for a period of 10 seconds, provided that the push button is not activated during this period. After the 10 seconds has elapsed, the display defaults to the "active" register defined by the status of the SR[0] and SR[1] inputs.

The register selected for display via the push button ( $\overline{\text{PB}}$ ) is indicated by the relevant annunciator.

## 6. Optical Interface

The SA9110A device contains an interface for automatic meter reading, according to the IEC1107 Mode D standard. The IEC1107 Mode D is a single baud rate of 2400. For the optical interface protocol, the 4-bit words are converted to 8-bit words (ASCII-format).

After initiation of a serial transmission by pulling  $\overline{PB}$  (pin 66) low, the data format transmitted on SDO, is given below:

| Code              | Description  |
|-------------------|--|
| /                 | Start transmission   |
| XXX               | ID   |
| 3                 | Baud rate identification   |
| YYYYYYYY          | ID   |
| <cr><lf><cr><lf>  | Data header  |
| 0(nnnnnnnn)       | Data of Reg. 1 (sign, $10e^5$ , $10e^4$ ... $10e^0$ , $10e^{-1}$ ) |
| 1(nnnnnnnn)       | Data of Reg. 2   |
| 2(nnnnnnnn)       | Data of Reg. 3   |
| 3(nnnnnnnn)       | Data of Reg. 4   |
| 4(nnnnnnnn)       | Data of Reg. 'Total' = Sum of registers 1 to 4                     |
| !<cr><lf><cr><lf> | End transmission   |

## 7. Power Failure/Battery Backup

A battery backup facility is available on VBA. This feature is provided to ensure retention of the information stored in the registers, in case of power breaks.

The VSS supply to the analog circuitry and digital circuitry has been separated. In the event of a power failure, the supply to the analog circuitry falls to 0V. The digital circuitry is switched to a power down mode, to minimise the supply current from an external battery backup. During this procedure, the following events take place:

- All inputs are disabled
- All outputs are placed in high impedance mode
- The oscillator is inhibited
- The LCD driver is disabled
- The contents of the RAM is retained by means of an external power source.

## 8. Electrostatic Discharge (ESD) Protection

The SA9110A integrated circuits inputs/outputs are protected against ESD.

## 9. Power Consumption

The power consumption rating of the SA9110A integrated circuit is less than 40mW with a 5V supply.



**TYPICAL APPLICATION**

In the Application Circuit (Figure 1), the components required for a three phase power metering application are shown. Terminated current transformers are used for current sensing.

The most important external components for the SA9110A integrated circuit are:

$C_7$ ,  $C_9$ ,  $C_{10}$  and  $C_{11}$  are the outer loop capacitors for the integrated oversampling A/D converters. The typical value of  $C_7$  is 2.2nF and the value of  $C_9$ ,  $C_{10}$  and  $C_{11}$  is 560pF.

The actual values determine the signal to noise and stability performance. The tolerances should be within  $\pm 10\%$ .

$C_4$ ,  $C_5$ ,  $C_6$  and  $C_8$  are the inner loop capacitors for the integrated oversampling A/D converters. The typical value of  $C_4$ ,  $C_5$ ,  $C_6$  and  $C_8$  is 3.3nF. Values smaller than 0.5nF and larger than 5nF should be avoided.

Terminated current sensors (current transformers) are connected to the current sensor inputs of the SA9110A through current setting resistors ( $R_8 \dots R_{13}$ ).

The resistor values should be selected for an input current of  $16\mu A_{RMS}$  into the SA9110A, at the rated line current.

The values of these resistors should be calculated as follows:

Phase 1:

$$R_8 = R_9 = (I_{L1}/16\mu A_{RMS}) * R_{18}/2$$

Phase 2:

$$R_{10} = R_{11} = (I_{L2}/16\mu A_{RMS}) * R_{19}/2$$

Phase 3:

$$R_{12} = R_{13} = (I_{L3}/16\mu A_{RMS}) * R_{20}/2$$

Where  $I_{LX}$  = Secondary CT current at rated conditions.

$R_{18}$ ,  $R_{19}$  and  $R_{20}$  = Current transformer termination resistors for the three phases.

$R_1$ ,  $R_4$  and  $R_{15}$  set the current for the phase 1 voltage sense input.  $R_2$ ,  $R_5$  and  $R_{16}$  set the current for phase 2 and  $R_3$ ,  $R_6$  and  $R_{17}$  set the current for phase 3. The values should be selected so that the input currents into the voltage sense inputs (virtual ground) are set to  $14\mu A_{RMS}$  for nominal line voltage. Capacitors C1, C2 and C3 are for decoupling and phase compensation.

$R_7$  defines all on-chip bias and reference currents ( $I_R$ ). With  $R_7 = 24k\Omega$ , optimum conditions are set.  $R_7$  may be varied within  $\pm 10\%$  for calibration purposes. Any changes to  $R_7$  will affect the output quadratically (i.e:  $\Delta R = +5\%$ ,  $\Delta f = +10\%$ ).

XTAL is a colour burst TV crystal ( $f = 3.5795MHz$ ) for the oscillator. The oscillator frequency is divided down to 1.7897MHz on-chip to supply the digital circuitry and the A/D converters.



Figure 1: Application circuit using current transformers for current sensing.

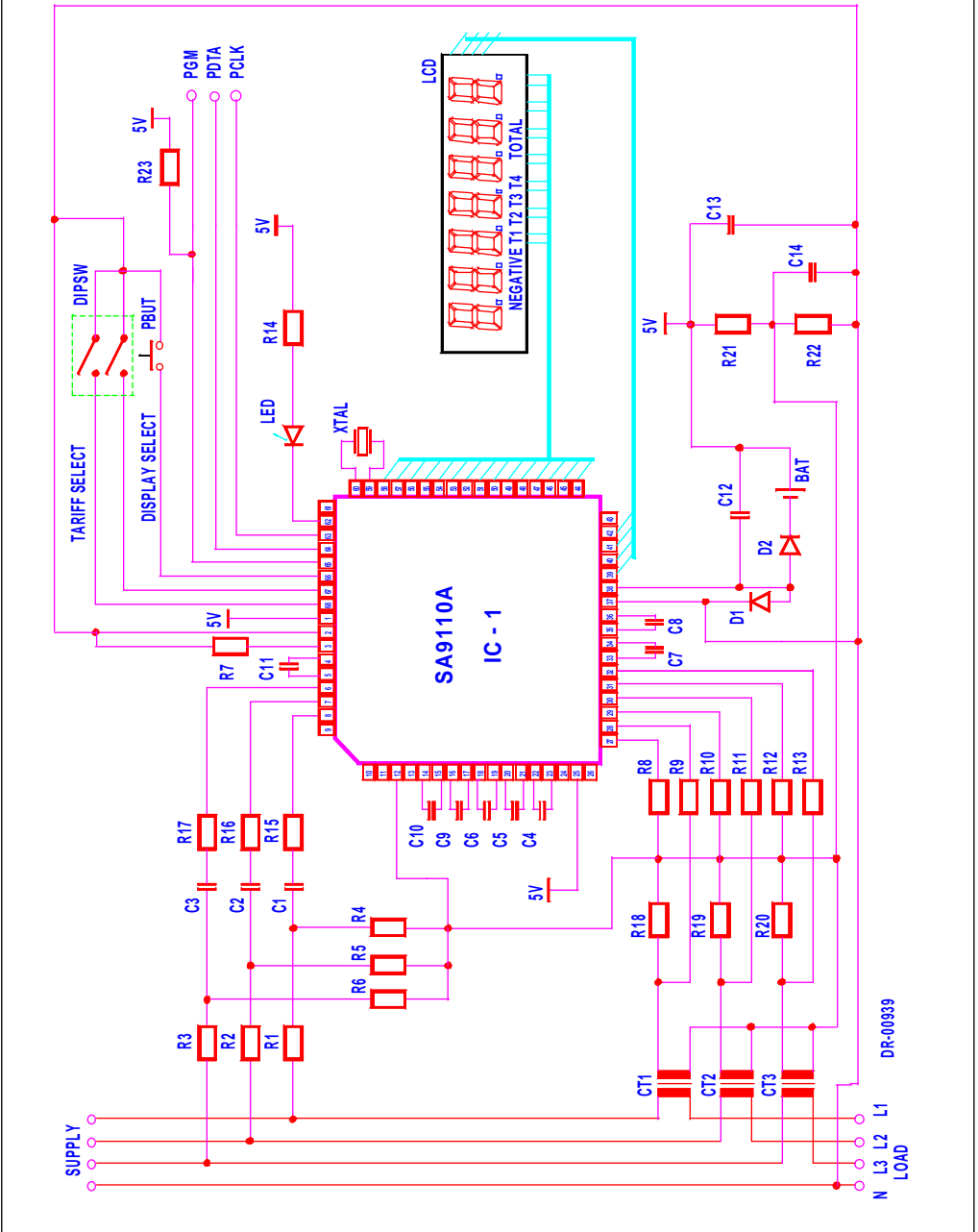

## Parts List for Application Circuit: Figure 1

| Item | Symbol | Description                       | Detail          |
|------|--------|-----------------------------------|-----------------|
| 1    | IC-1   | SA9110AFA                         | PLCC-68         |
| 2    | XTAL   | Crystal, 3.5795 MHz               | Colour burst TV |
| 3    | R1     | Resistor, 390k, 1%, ¼W            | Note 1          |
| 4    | R2     | Resistor, 390k, 1%, ¼W            | Note 1          |
| 5    | R3     | Resistor, 390k, 1%, ¼W            | Note 1          |
| 6    | R4     | Resistor, 24k, 1%, ¼W             | Note 1          |
| 7    | R5     | Resistor, 24k, 1%, ¼W             | Note 1          |
| 8    | R6     | Resistor, 24k, 1%, ¼W             | Note 1          |
| 9    | R7     | Resistor, 24k, 1%, ¼W             |                 |
| 10   | R8     | Resistor                          | Note 2          |
| 11   | R9     | Resistor                          | Note 2          |
| 12   | R10    | Resistor                          | Note 2          |
| 13   | R11    | Resistor                          | Note 2          |
| 14   | R12    | Resistor                          | Note 2          |
| 15   | R13    | Resistor                          | Note 2          |
| 16   | R14    | Resistor, 820Ω, 1%, ¼W            |                 |
| 17   | R15    | Resistor, 1M, 1%, ¼W              | Note 1          |
| 18   | R16    | Resistor, 1M, 1%, ¼W              | Note 1          |
| 19   | R17    | Resistor, 1M, 1%, ¼W              | Note 1          |
| 20   | R18    | Resistor                          | Note 2          |
| 21   | R19    | Resistor                          | Note 2          |
| 22   | R20    | Resistor                          | Note 2          |
| 23   | R21    | Resistor, 820Ω, 1%, ¼W            |                 |
| 24   | R22    | Resistor, 820Ω, 1%, ¼W            |                 |
| 25   | R23    | Resistor, 470Ω                    |                 |
| 26   | C1     | Capacitor, electrolytic, 1μF, 16V | Note 3          |
| 27   | C2     | Capacitor, electrolytic, 1μF, 16V | Note 3          |
| 28   | C3     | Capacitor, electrolytic, 1μF, 16V | Note 3          |
| 29   | C4     | Capacitor, 3.3nF                  |                 |
| 30   | C5     | Capacitor, 3.3nF                  |                 |
| 31   | C6     | Capacitor, 3.3nF                  |                 |
| 32   | C7     | Capacitor, 2.2nF                  |                 |
| 33   | C8     | Capacitor, 3.3nF                  |                 |
| 34   | C9     | Capacitor, 560pF                  |                 |
| 35   | C10    | Capacitor, 560pF                  |                 |
| 36   | C11    | Capacitor, 560pF                  |                 |
| 37   | C12    | Capacitor, 100nF                  |                 |
| 38   | C13    | Capacitor, 820nF                  | Note 4          |
| 39   | C14    | Capacitor, 100nF                  |                 |
| 40   | BAT    | Battery (1.2V)                    |                 |





**Parts List for Application Circuit: Figure 1 (Continued)**

| Item | Symbol | Description          | Detail |
|------|--------|----------------------|--------|
| 41   | LED    | Light emitting diode |        |
| 42   | D1     | Diode, Shottkey      |        |
| 43   | D2     | Diode, 1N4148        |        |
| 44   | DIPSW  | DIP swich, 2 poles   |        |
| 45   | PBUT   | Push button          |        |

Note 1 : Resistor values are dependant upon the rated mains voltage (230V in this case)

Note 2 : Resistor ( $R_8$ ,  $R_9$ ,  $R_{10}$ ,  $R_{11}$ ,  $R_{12}$  and  $R_{13}$ ) values are dependant upon the selected values of the current transformer termination resistors  $R_{18}$ ,  $R_{19}$  and  $R_{20}$ .

Note 3 : Capacitor values may be selected to compensate for phase errors caused by the current transformers.

Note 4 : Capacitor (C13) to be positioned as close to supply pins ( $V_{DD}$  &  $V_{SS}$ ) of IC-1, as possible.

**ORDERING INFORMATION**

| Part Number | Package |
|-------------|---------|
| SA9110AFA   | PLCC-68 |



**Disclaimer:** The information contained in this document is confidential and proprietary to South African Micro-Electronic Systems (Pty) Ltd ("SAMES") and may not be copied or disclosed to a third party, in whole or in part, without the express written consent of SAMES. The information contained herein is current as of the date of publication; however, delivery of this document shall not under any circumstances create any implication that the information contained herein is correct as of any time subsequent to such date. SAMES does not undertake to inform any recipient of this document of any changes in the information contained herein, and SAMES expressly reserves the right to make changes in such information, without notification, even if such changes would render information contained herein inaccurate or incomplete. SAMES makes no representation or warranty that any circuit designed by reference to the information contained herein, will function without errors and as intended by the designer.

Any Sales or technical questions may be posted to our e-mail address below:  
[energy@sames.co.za](mailto:energy@sames.co.za)

For the latest updates on datasheets, please visit our web site:  
<http://www.sames.co.za>

**South African Micro-Electronic Systems (Pty) Ltd**

P O Box 15888,  
Lynn East, 0039  
Republic of South Africa,

33 Eland Street,  
Koedoespoort Industrial Area,  
Pretoria,  
Republic of South Africa

Tel: 012 333-6021  
Fax: 012 333-8071

Tel: Int +27 12 333-6021  
Fax: Int +27 12 333-8071

