

Typical Applications

- TDMA Handsets

Product Description

The RF2475 includes two downconverting mixers and associated LNAs. It is designed for IS136 handset applications in the cellular 800MHz and PCS 1900MHz bands. Each LNA has a gain bypass mode, which is controlled by the gain select pin. The device internally ties the two mixer outputs together, providing interface to a single IF SAW filter. A frequency doubler is provided to supply the LO signal to the PCS mixer and feeds the PCS transmit LO output buffer. A cellular LO output buffer is also included. The device is fabricated using Gallium Arsenide HBT technology and is packaged in a 28-pin, 5mmx5mm leadless package.

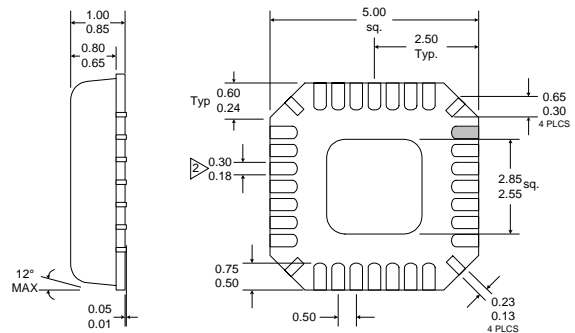

- NOTES:**
- 1 Shaded Pin is Lead 1.
  - Dimension applies to plated terminal: to be measured between 0.02 mm and 0.25 mm from terminal end.
  - Pin 1 identifier must exist on top surface of package by identification mark or feature on the package body. Exact shape and size is optional.
  - Package Warpage: 0.05 mm max.
  - Die Thickness Allowable: 0.305 mm max.

Optimum Technology Matching® Applied

- Si BJT       GaAs HBT       GaAs MESFET  
 Si Bi-CMOS       SiGe

Package Style: LCC, 28-Pin, 5x5

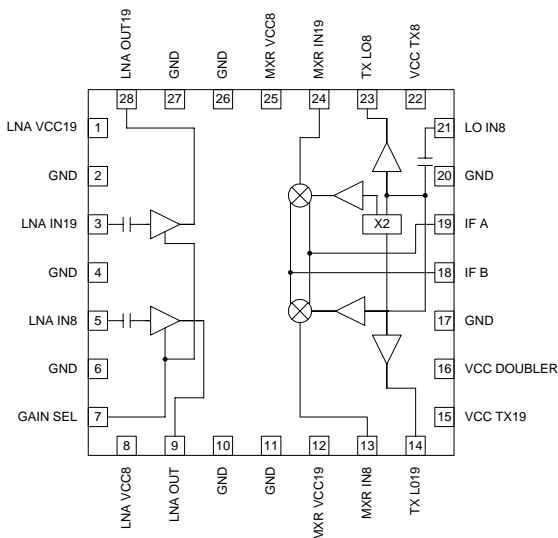

Functional Block Diagram

Features

- Complete Dual-Band Receiver Front-End
- Stepped LNA Gain Control
- Integrated LO Frequency Doubler
- Integrated LO Output Buffers
- Meets IS136 Specifications

Ordering Information

- RF2475      Dual-Band Low Noise Amplifier/Mixer with Frequency Doubler  
 RF2475 PCBA      Fully Assembled Evaluation Board

RF Micro Devices, Inc.  
7628 Thorndike Road  
Greensboro, NC 27409, USA

Tel (336) 664 1233  
Fax (336) 664 0454  
<http://www.rfmd.com>

### Absolute Maximum Ratings

Parameter	Rating	Unit
Supply Voltage	-0.5 to +5.0	V <sub>DC</sub>
Input LO and RF Levels	+6	dBm
Operating Ambient Temperature	-30 to +85	°C
Storage Temperature	-40 to +150	°C



**Caution!** ESD sensitive device.

RF Micro Devices believes the furnished information is correct and accurate at the time of this printing. However, RF Micro Devices reserves the right to make changes to its products without notice. RF Micro Devices does not assume responsibility for the use of the described product(s).

Parameter	Specification			Unit	Condition
	Min.	Typ.	Max.		
<b>Cellular Receive Path</b>					
<b>Operational Limits</b>					
RF Frequency	869		894	MHz	
LO Frequency	950		1045	MHz	
IF Frequency	100		150	MHz	
LNA Input Level			+10	dBm	
LO Input Level	-10	-7	-4	dBm	
Supply Voltage	2.7	2.8	3.3	V	
<b>Cellular Cascaded Electrical Specifications</b>					
Gain	23	25	27	dB	T <sub>AMB</sub> =25°C, V <sub>CC</sub> =2.8V, f <sub>RF</sub> =881MHz, f <sub>LO</sub> =1016MHz, f <sub>IF</sub> =135MHz, LO Level=-7dBm, Image Filter I.L.=3dB
		8		dB	High Gain, Gain Select=High
				dB	Low Gain, Gain Select=Low
Gain Step	14	17		dB	
Gain Variations versus Temperature			±1.5	dB	-30°C to +85°C
Noise Figure		2.2	2.6	dB	High Gain, Gain Select=High
		15	20	dB	Low Gain, Gain Select=Low
Input Third Order Intercept <sup>1</sup>	-10	-9		dBm	High Gain, Gain Select=High
	-2.0	-0.5		dBm	Low Gain, Gain Select=Low
Return Loss	10			dB	LNA Input - External Match
	10			dB	LNA Output - External Match
	10			dB	Mixer RF Input - External Match
	10			dB	Mixer LO Input - External Match
Isolation	60			dB	LO IN to LNA IN, Gain Select=High <sup>2</sup>
	60			dB	LO IN to LNA IN, Gain Select=Low
		60		dB	Image Rejection <sup>3</sup>
		50		dB	LO IN to IF OUT
		50		dB	Mixer RF IN to IF OUT
		35		dB	Mixer RF IN to TX LO OUT
IF Output Impedance		>10		kΩ	Mixer "ON"
Supply Current		20	25	mA	Not including TX LO buffer
<b>TX LO Buffer</b>					
LO Output Buffer	-7	-4		dBm	LO Input Level=-7dBm
Harmonic Output	-22	-25		dBc	LO Input Level=-7dBm
Isolation - LO OUT to LO IN	25			dB	TX LO Buffer ON
Supply Current		7.5	9.0	mA	
<b>Logic</b>					
Input Low			0.5	V	V <sub>CC</sub> =2.7V to 2.9V
Input High	2.0			V	V <sub>CC</sub> =2.7V to 2.9V
Input Current		TBD		μA	
Input Impedance		TBD		kΩ	

**NOTES:**

- 1 LNA input IP3 response to out of band frequencies (824Hz to 849MHz) should be -6dBm in high gain mode.
- 2 LO IN to LNA IN isolation specification with the 900MHz TX LO buffer on.
- 3 Image rejection measured with f<sub>RF</sub>=869MHz, P<sub>RF</sub>=-105dBm, f<sub>LO</sub>=1004MHz; P<sub>IMAGE</sub>=-85dBm, f<sub>IMAGE</sub>=1139MHz

Parameter	Specification			Unit	Condition
	Min.	Typ.	Max.		
<b>Cellular Receive Path, Cont'd</b>					
<b>Cellular Block Level Electrical Specifications</b>					
<b>Low Noise Amplifier</b>					
Frequency Range	869		894	MHz	
Gain		20		dB	High Gain, Gain Select=High
		3	6	dB	Low Gain, Gain Select=Low
Gain Step	14	17		dB	
Gain Variations versus Temperature			±1.0	dB	-30°C to +85°C
Noise Figure		1.4	1.6	dB	High Gain, Gain Select=High
				dB	Low Gain, Gain Select=Low
Input Third Order Intercept	-3	0		dBm	High Gain, Gain Select=High
	-3	0		dBm	Low Gain, Gain Select=Low
Terminating Impedance		50		Ω	External Match
Supply Current		6	8	mA	High Gain, Gain Select=High
		6	8	mA	Low Gain, Gain Select=Low
Logic Input Low			0.5	V	V <sub>CC</sub> =2.7V to 2.9V
Logic Input High	2.0			V	V <sub>CC</sub> =2.7V to 2.9V
<b>Mixer and LO Buffer</b>					
Frequency Range, Mixer Input	869		894	MHz	
Frequency Range, IF Output	85		150	MHz	
Frequency Range, LO Input	950		1045	MHz	
Conversion Gain	7	8	9	dB	
Noise Figure (SSB)		11	12	dB	
Input Third Order Intercept	7	8		dBm	
Terminating Impedance, Mixer In, LO In, LO Out		50		Ω	External Match
Terminating Impedance, Mixer In, LO In, LO Out		10		Ω	External Match
Return Loss		>10		kΩ	Mixer "ON"
Terminating Impedance, IF Out					
Mixer Supply Current		14	19	mA	
LO Input Level	-10	-7	-4	dBm	
LO Buffer Supply Current		7.5	9.0	mA	
LO Output Level	-7	-4		dBm	
<b>PCS Receive Path</b>					
<b>Operational Limits</b>					
RF Frequency	1930		1990	MHz	
Frequency Range, LO Input to Doubler	1015	1039	1063	MHz	LO input to device at LO IN8.
Frequency Range, Doubler Output	2030	2078	2126	MHz	Internal output of LO doubler driving the mixer and TX LO buffer.
IF Frequency	100		150	MHz	
LNA Input Level			+10	dBm	
LO Input Level	-10	-7	-4	dBm	
Supply Voltage	2.7	2.8	3.3	V	

FRONT-ENDS

Parameter	Specification			Unit	Condition
	Min.	Typ.	Max.		
<b>PCS Receive Path, Cont'd</b>					
<b>PCS Cascaded Electrical Specifications</b>					
Gain	24	26	28	dB	$T_{AMB}=25^{\circ}C$ , $V_{CC}=2.8V$ , $f_{RF}=1960MHz$ , $f_{LO}=2095MHz$ , $f_{IF}=135MHz$ , LO Level=-7dBm, Image Filter I.L.=3dB
Gain Step	17	20		dB	High Gain, Gain Select=High
Gain Variations versus Temperature			$\pm 1.5$	dB	Low Gain, Gain Select=Low
Noise Figure		2.8	3.3	dB	-30°C to +85°C
Input Third Order Intercept	-12	-10	20	dBm	High Gain, Gain Select=High
Return Loss	-2	-0.5		dBm	Low Gain, Gain Select=Low
Isolation	10			dB	LNA Input - External Match
	10			dB	LNA Output - External Match
	10			dB	Mixer RF Input - External Match
	10			dB	Mixer LO Input - External Match
	40			dB	LO IN to LNA IN, Gain Select=High <sup>4</sup>
	40			dB	LO IN to LNA IN, Gain Select=Low
Half IF Spur <sup>6</sup>	35	37		dB	Image Rejection <sup>5</sup>
IF Output Impedance		>53		dB	LO IN to IF OUT
Supply Current		>40		dB	Mixer RF IN to IF OUT
		35		dB	Mixer RF IN to TX LO OUT
		-68		dBc	
		>10		k $\Omega$	Mixer "ON"
		28	33	mA	Including the LO doubler, but not the TX LO buffer
<b>TX LO Buffer</b>					
LO Doubler Output Buffer	-5	-3		dBm	LO Input Level=-7dBm
Harmonic Output	-22	-25		dBc	LO Input Level=-7dBm
Doubler Harmonic Output	-45	-50		dBc	Fundamental Suppression
Isolation - LO OUT to LO IN	35			dB	TX LO Buffer ON
Supply Current		7.5	9.0	mA	Including the LO doubler and the TX LO buffer
<b>Logic</b>					
Input Low			0.5	V	$V_{CC}=2.7V$ to $2.9V$
Input High	2.0			V	$V_{CC}=2.7V$ to $2.9V$
Input Current		TBD		$\mu A$	
Input Impedance		TBD		k $\Omega$	

**NOTES:**

- 4 LO IN to LNA IN isolation specification with the 1900MHz TX LO buffer on.
- 5 Image rejection measured with  $f_{RF}=1930MHz$ ,  $P_{RF}=-105dBm$ ,  $f_{LO}=2065MHz$ ;  $P_{IMAGE}=-85dBm$ ,  $f_{IMAGE}=2220MHz$ . Image interferer should be suppressed 11 dB below desired signal at the IF output.
- 6  $2LO \pm 2RF$  Half IF Spur. (1/2 IF spur relative to  $P_{1/2RF}$ )  $f_{RF}=1930MHz$ ,  $P_{RF}=-105dBm$ ,  $f_{LO}=2065MHz$ ;  $F_{1/2IF}=1997.5MHz$ ,  $P_{1/2IF}=-48dBm$ .  
1/2 IF interferer should be suppressed 11 dB below desired signal at the IF output.

Parameter	Specification			Unit	Condition
	Min.	Typ.	Max.		
<b>PCS Receive Path, Cont'd</b>					
<b>PCS Block Level</b>					
<b>Electrical Specifications</b>					
<b>Low Noise Amplifier</b>					
Frequency Range	1930		1990	MHz	
Gain		22		dB	High Gain, Gain Select=High
		2		dB	Low Gain, Gain Select=Low
Gain Step	16	20		dB	
Gain Variations versus Temperature			±1.0	dB	-30°C to +85°C
Noise Figure		1.7	1.9	dB	High Gain, Gain Select=High
				dB	Low Gain, Gain Select=Low
Input Third Order Intercept	-7	-6		dBm	High Gain, Gain Select=High
	-2	0		dBm	Low Gain, Gain Select=Low
Terminating Impedance		50		Ω	
Supply Current		8	9	mA	High Gain, Gain Select=High
		8	9	mA	Low Gain, Gain Select=Low
Logic Input Low			0.5	V	V <sub>CC</sub> =2.7V to 2.9V
Logic Input High	2.0			V	V <sub>CC</sub> =2.7V to 2.9V
<b>Mixer and LO Buffer</b>					
Frequency Range, Mixer Input	1930		1990	MHz	
Frequency Range, IF Output	100		150	MHz	
Frequency Range, LO Input to Doubler	1015	1039	1063	MHz	LO input to device at LO IN8.
Frequency Range, Doubler Output	2030	2078	2126	MHz	Internal output of LO doubler driving the mixer and TX LO buffer.
Conversion Gain	7	8	9	dB	
Noise Figure (SSB)		13	4	dB	
Input Second Order Intercept		35		dBm	
Input Third Order Intercept	7	8		dBm	
Terminating Impedance, Mixer In, LO In, LO Out		50		Ω	External Match
Terminating Impedance, Mixer In, LO In, LO Out Return Loss		10		Ω	External Match
Terminating Impedance, IF Out		>10		kΩ	Mixer "ON"
Mixer Supply Current		23	28	mA	Including the LO doubler, but not the TX LO buffer
LO Input Level	-10	-7	-4	dBm	
LO Buffer Supply Current		7.5	8.0	mA	Including the LO doubler and the TX LO buffer
LO Output Level	-5	-2		dBm	

Pin	Function	Description	Interface Schematic
1	LNA VCC19	PCS LNA supply voltage. Local bypass capacitor required.	
2	GND	Ground connection. Keep traces physically short and connect immediately to ground plane for best performance.	
3	LNA IN19	PCS LNA input. AC-coupled. Requires external 50Ω matching components.	
4	GND	Ground connection. Keep traces physically short and connect immediately to ground plane for best performance.	
5	LNA IN8	Cellular LNA input. AC-coupled. Requires external 50Ω matching components.	
6	GND	Ground connection. Keep traces physically short and connect immediately to ground plane for best performance.	
7	GAIN SEL	Gain select control input. Logic high=high gain, logic low=low gain.	
8	LNA VCC8	Cellular LNA RF supply voltage. Local bypass capacitor required.	
9	LNA OUT	Cellular LNA output. AC-coupled. Requires matching to 50Ω.	
10	GND	Ground connection. Keep traces physically short and connect immediately to ground plane for best performance.	
11	GND	Ground connection. Keep traces physically short and connect immediately to ground plane for best performance.	
12	MXR VCC19	PCS mixer and RX LO doubler enable supply voltage. Local bypass capacitor required.	
13	MXR IN8	Cellular RF mixer input. AC-coupled. Requires matching to 50Ω.	
14	TX LO19	PCS Transmit LO buffer output. Requires matching to 50Ω.	
15	VCC TX19	PCS TX LO buffer and TX LO doubler enable supply voltage. Local bypass capacitor required.	
16	VCC DOUBLER	Doubler output supply voltage for PCS RX and PCS TX modes. See Note 1.	
17	GND	Ground connection. Keep traces physically short and connect immediately to ground plane for best performance.	
18	IF B	Mixer IF B output. Open collector output, requires external matching components and DC connection to VCC.	
19	IF A	Mixer IF A output. Open collector output, requires external matching components and DC connection to VCC.	
20	GND	Ground connection. Keep traces physically short and connect immediately to ground plane for best performance.	
21	LO IN8	Mixer LO input. AC-coupled. Requires matching to 50Ω.	
22	VCC TX8	Cellular TX LO buffer supply voltage. Local bypass capacitor required.	
23	TX LO8	Cellular TX LO buffer output. AC-coupled. Requires matching to 50Ω.	
24	MXR IN19	PCS RF mixer input. AC-coupled. Requires matching to 50Ω.	
25	MXR VCC8	Cellular mixer supply voltage. Local bypass capacitor required.	
26	GND	Ground connection. Keep traces physically short and connect immediately to ground plane for best performance.	
27	GND	Ground connection. Keep traces physically short and connect immediately to ground plane for best performance.	
28	LNA OUT19	PCS LNA output. AC-coupled. Requires matching to 50Ω.	
Pkg Base	GND	Ground connection. The backside of the package should be soldered to a top side ground pad which is connected to the ground plane with multiple vias. The pad should have a short thermal path to the ground plane.	

## NOTE:

The LO doubler is enabled by either MXR VCC19 (PCS RX mode) or TX LO19 (PCS TX mode). VCC DOUBLER is the DC current return path for the output of the doubler. This should be connected to the PLL VCC or a supply that is on in both the TX and RX modes of the 1900MHz band of operation. In the Cellular mode, the doubler is powered down to save current, even when VCC DOUBLER is energized. Therefore, the VCC DOUBLER pin can be connected to a supply that is on in all modes, while minimizing the current consumption of the device.

Truth Table of Pin-by-Pin Biasing

Pin #	1	28	8	9	12	14	15	16	18	19	22	23	25
<b>Pin Name</b>	LNA VCC19	LNA OUT19	LNA VCC8	LNA OUT8	MXR VCC19	TX LO19	VCC TX19	DOUBLER VCC	IF B	IF A	VCC TX8	TX LO8	MXR VCC8
<b>Biased by VCC Supply</b>	RX19 VCC	RX19 VCC	RX8 VCC	RX8 VCC	RX19 VCC	TX19 VCC	TX19 VCC	PLL VCC	IF VCC	IF VCC	TX8 VCC	TX8 VCC	RX8 VCC
<b>Mode</b>													
<b>RX-800</b>	L	L	H	H	L	L	L	H	H	H	L	L	H
<b>RX-1900</b>	H	H	L	L	H	L	L	H	H	H	L	L	L
<b>TX-800</b>	L	L	L	L	L	L	L	H	L	L	H	H	L
<b>TX-1900</b>	L	L	L	L	L	H	H	H	L	L	L	L	L

L = Supply Off  
H = Supply On

Power Control Modes

Mode	Pin Name	Pin #	Controls the Following Circuit Functions
RX19	LNA VCC19	1	1900MHz LNA Bias
	MXR VCC19	12	Mixer RF Amplifier Mixer LO Driver RX LO Doubler
	Doubler VCC	16	DC Return for the LO Doubler
	IF B	18	DC Return for Mixer
	IF A	19	DC Return for Mixer
RX8	LNA VCC8	8	800MHz LNA Bias
	MXR VCC8	25	Mixer RF Amplifier Mixer LO Driver
	IF B	18	DC Return for Mixer
	IF A	19	DC Return for Mixer
TX8	VCC TX8	22	800MHz TX LO Buffer
TX19	VCC TX19	15	1900MHz TX LO Buffer TX LO Doubler
	Doubler VCC	16	DC Return for the LO Doubler

NOTES:

There are separate RX/TX LO doublers with a common output.  
The DC return path for both the TX and RX doublers is via the PLL VCC which is on in all TX and RX modes.  
This allows sharing of the LC load at the doubler output, which saves a significant amount of die area.

## Pin Out

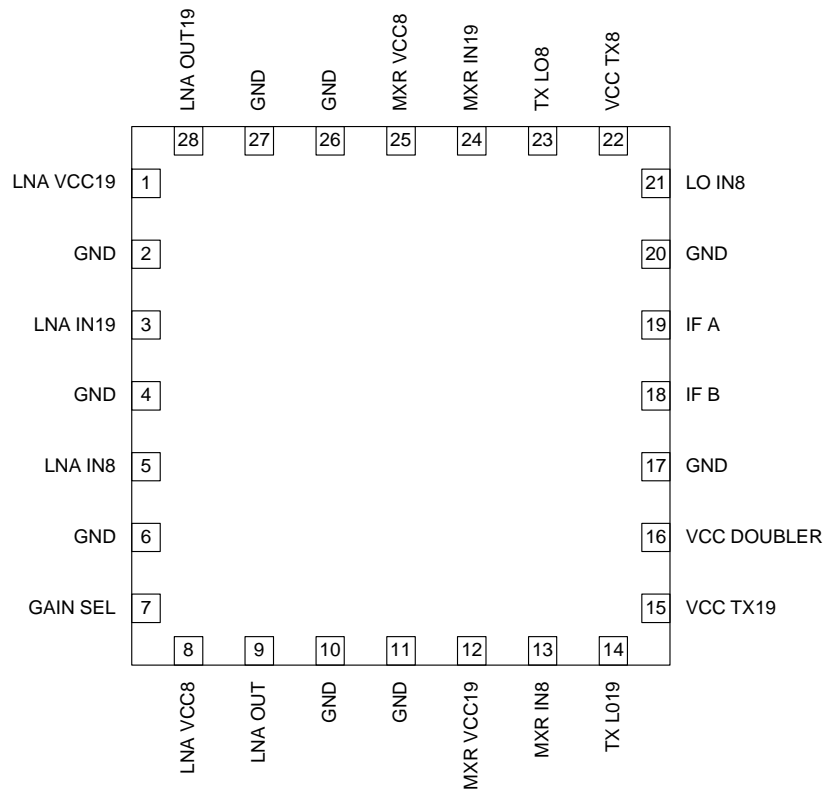



## Evaluation Board Schematic

(Download [Bill of Materials](http://www.rfmd.com) from www.rfmd.com.)

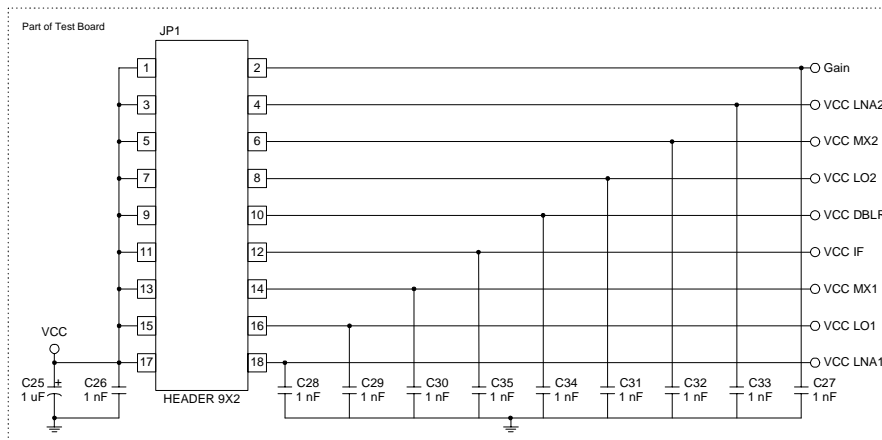
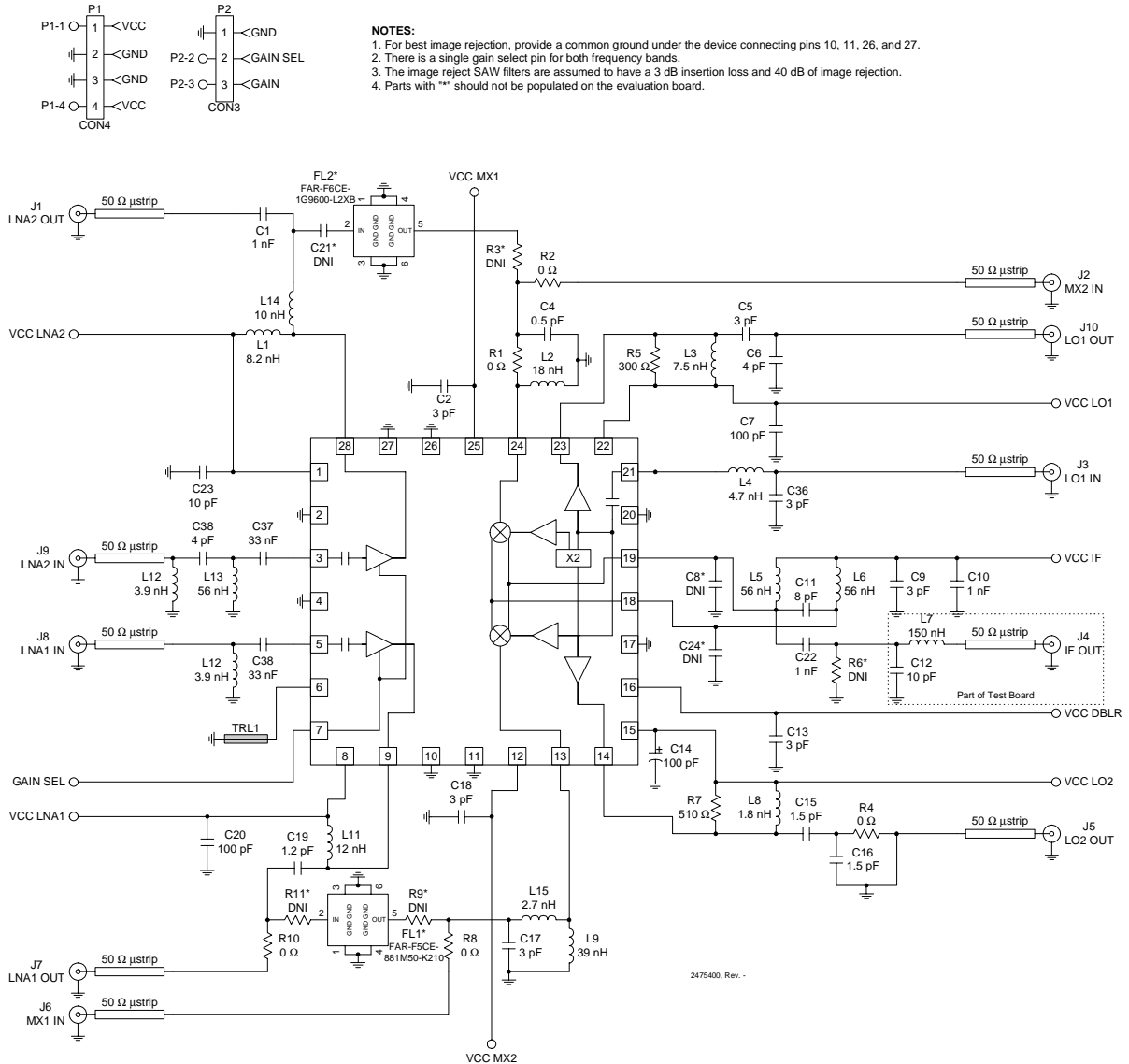

FRONT-ENDS

Evaluation Board Layout  
Board Size 2.6" x 2.0"

Board Thickness 0.058", Board Material FR-4, Multi-Layer

Assembly

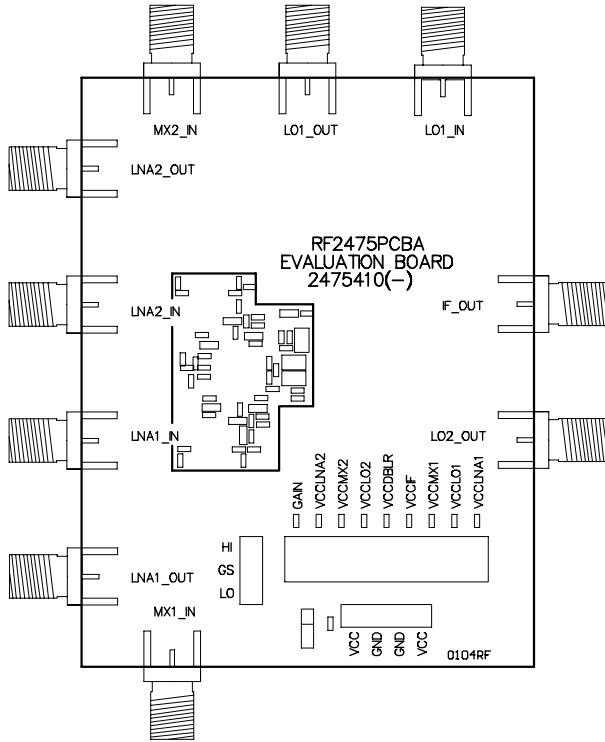

Top

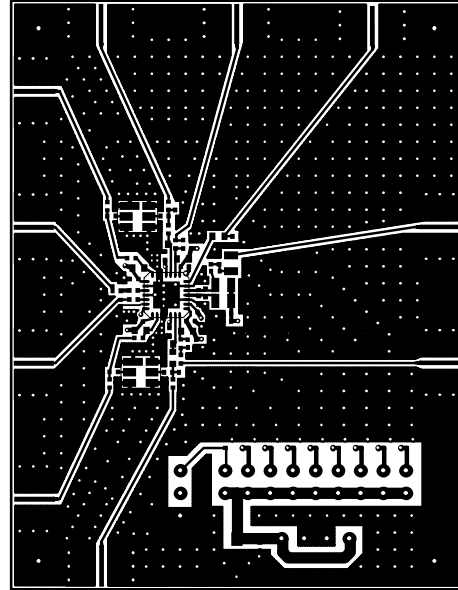

Inner 1

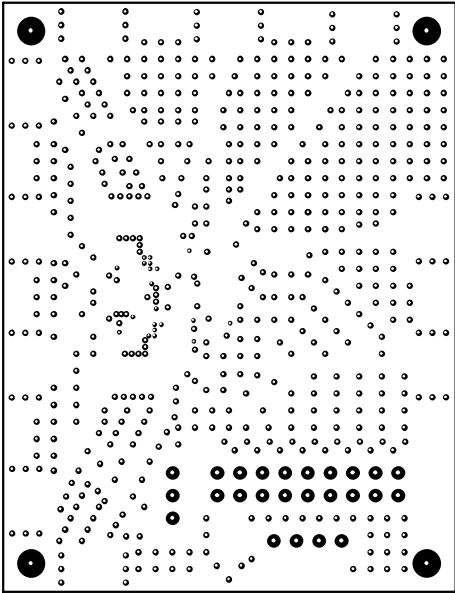

Inner 2

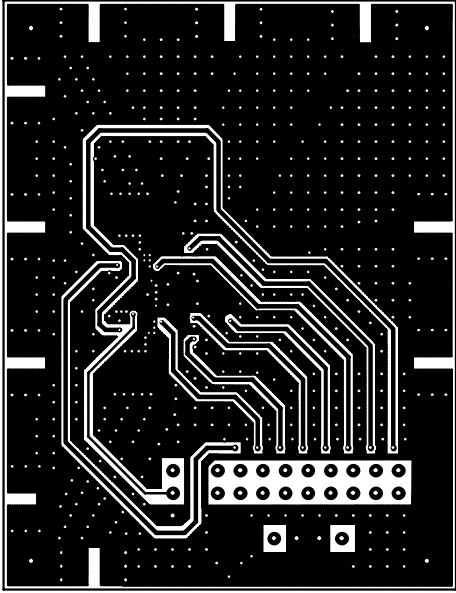

Back

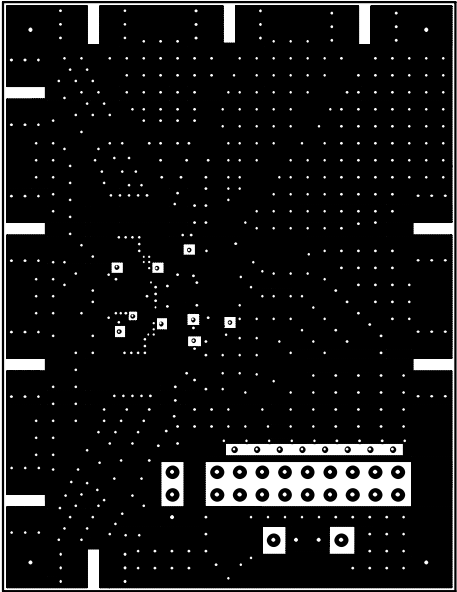

∞  
FRONT-ENDS

**LNA1 Gain versus Frequency**  
Gain Select=High, V<sub>CC</sub>=2.8 V

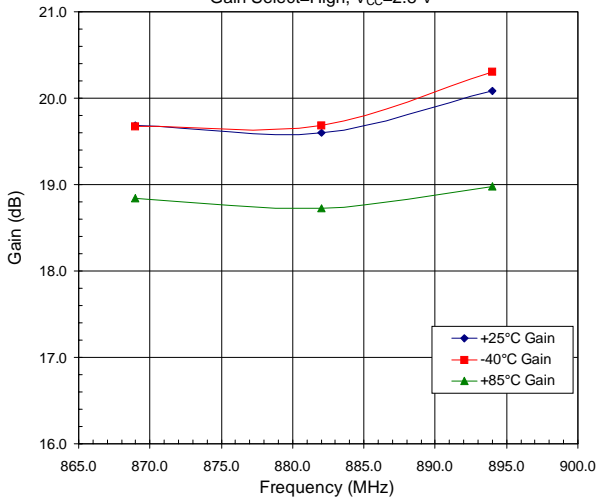

**LNA1 Gain versus Supply Voltage**  
Gain Select=High, 882 MHz

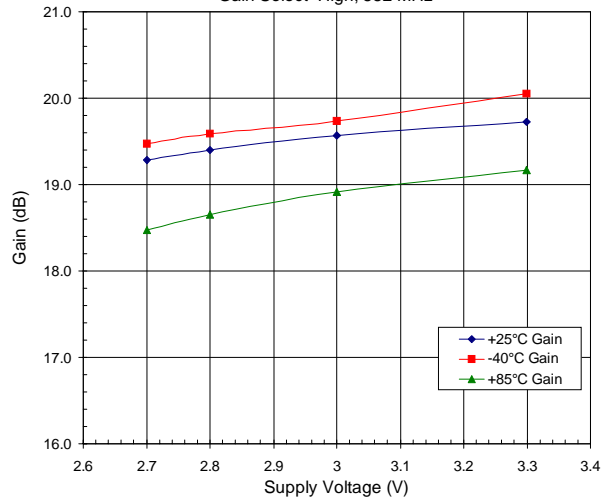

**LNA1 Noise Figure versus Frequency**  
Gain Select=High, V<sub>CC</sub>=2.8 V

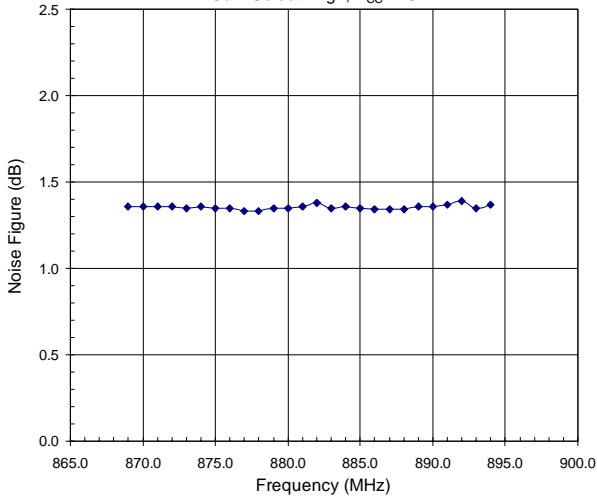

**LNA1 Noise Figure versus Supply Voltage**  
Gain Select=High, 882 MHz

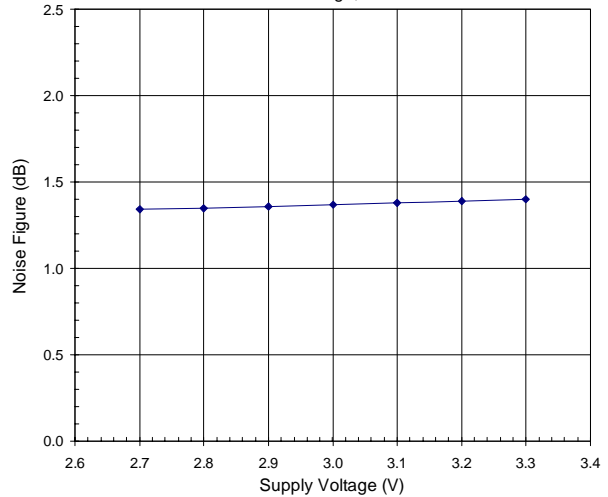

**LNA1 Input IP3 versus Frequency**  
Gain Select=High, -40 dBm per tone, 1 MHz Separation, V<sub>CC</sub>=2.8 V

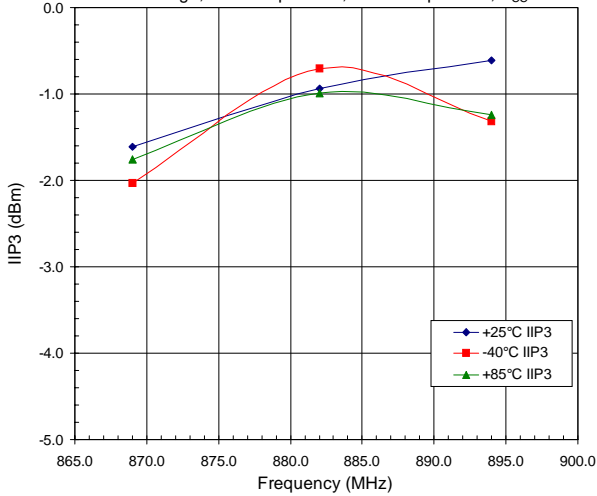

**LNA1 Input IP3 versus Supply Voltage**  
Gain Select=High, 882/883 MHz, -40dBm per tone

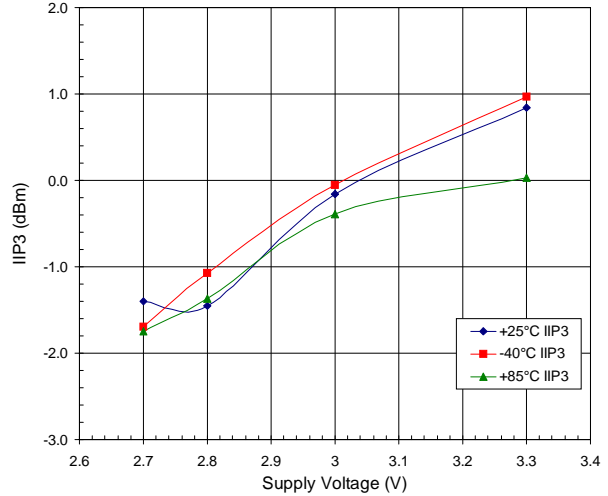

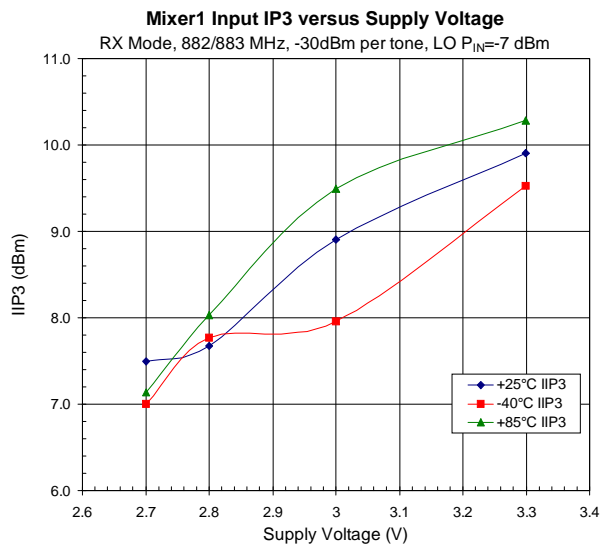
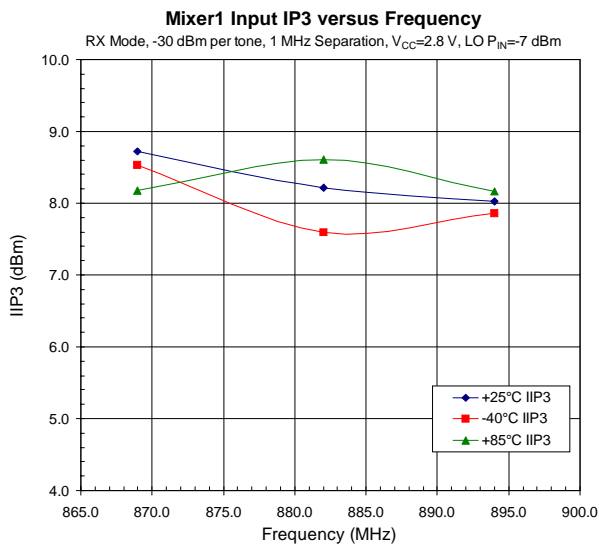
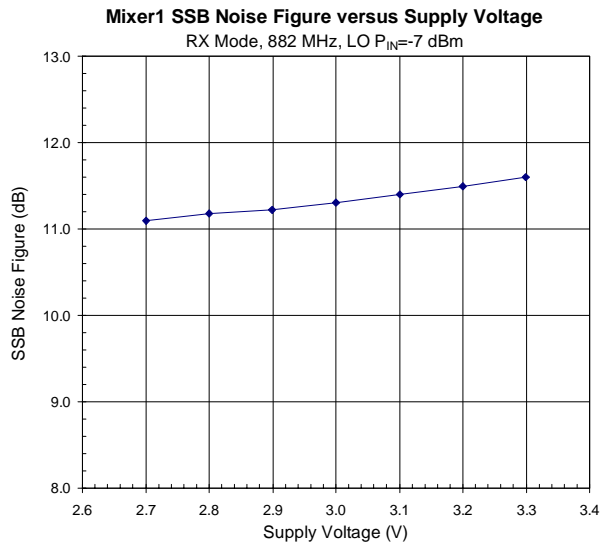
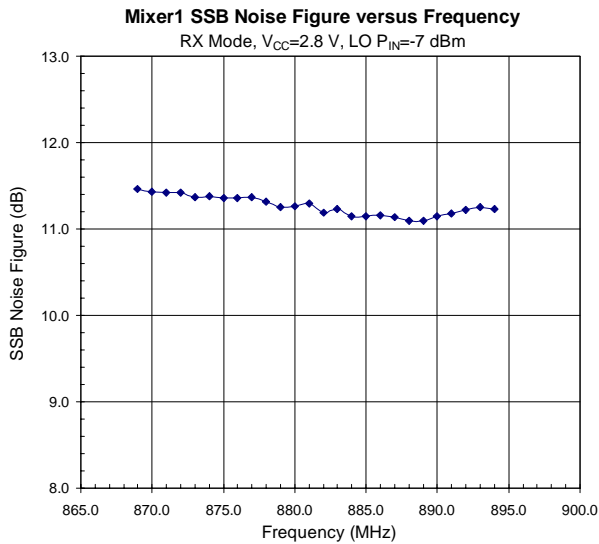
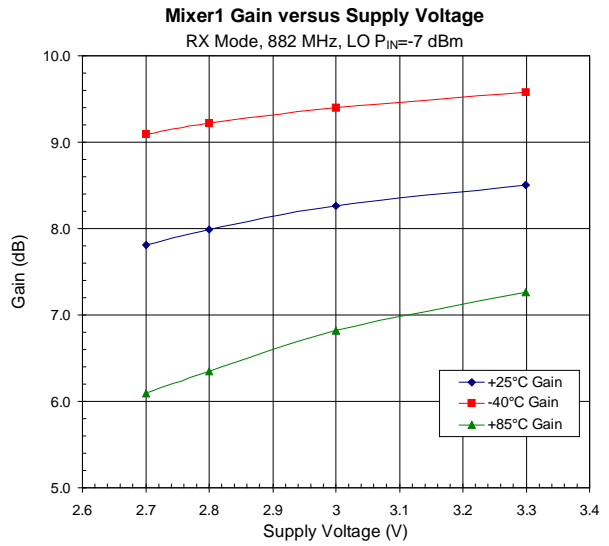
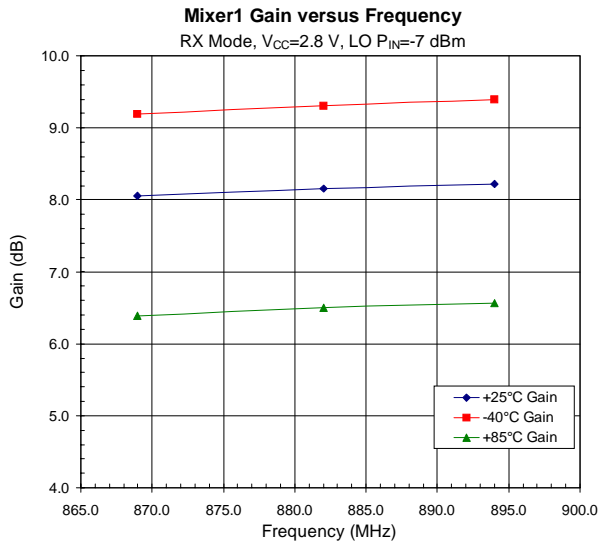

**LNA2 Gain versus Frequency**  
Gain Select=High,  $V_{CC}=2.8$  V

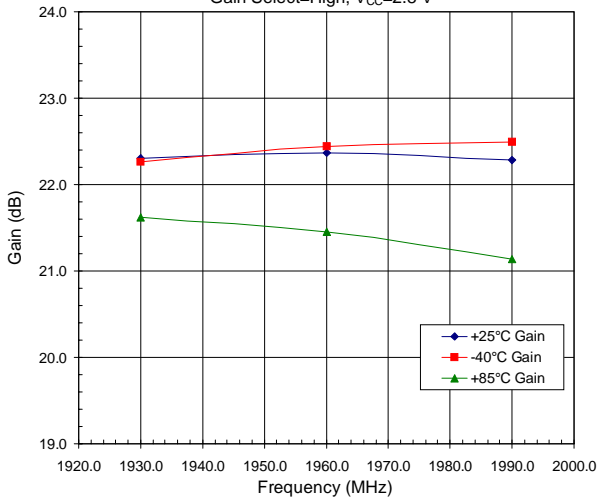

**LNA2 Gain versus Supply Voltage**  
Gain Select=High, 1960 MHz

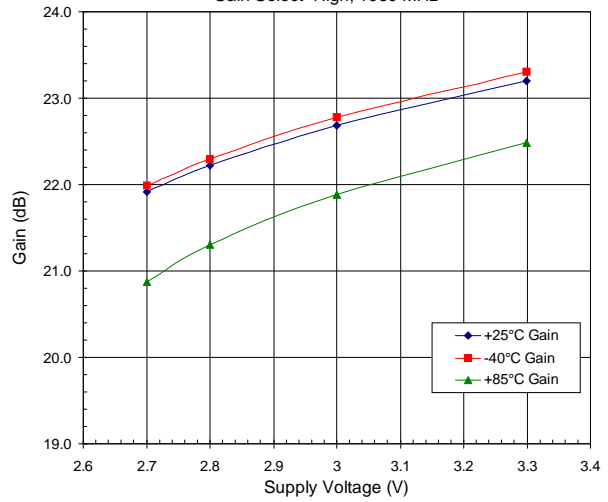

**LNA2 Noise Figure versus Frequency**  
Gain Select=High,  $V_{CC}=2.8$  V

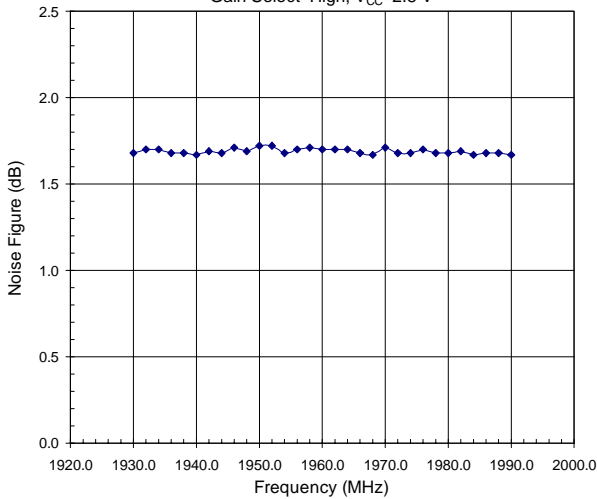

**LNA2 Noise Figure versus Supply Voltage**  
Gain Select=High, 1960 MHz

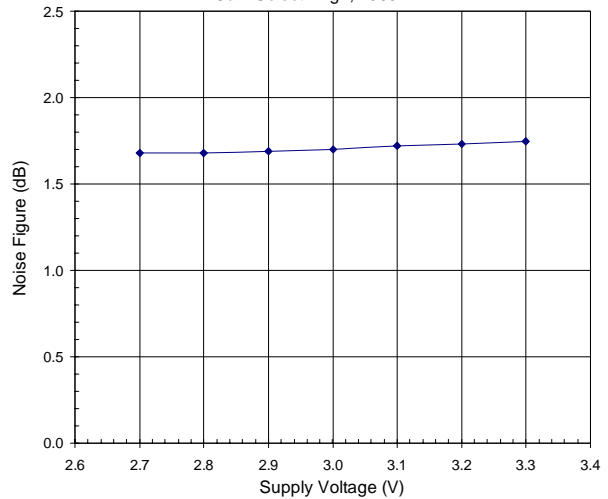

**LNA2 Input IP3 versus Frequency**  
Gain Select=High, -40 dBm per tone, 1 MHz Separation,  $V_{CC}=2.8$  V

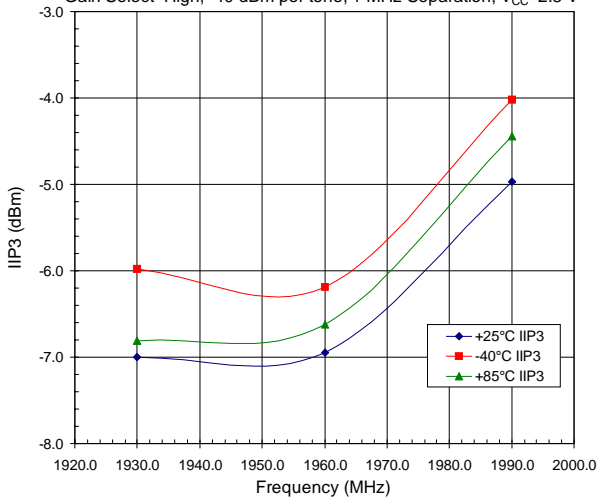

**LNA2 Input IP3 versus Supply Voltage**  
Gain Select=High, 1960/1961 MHz, -40 dBm per tone

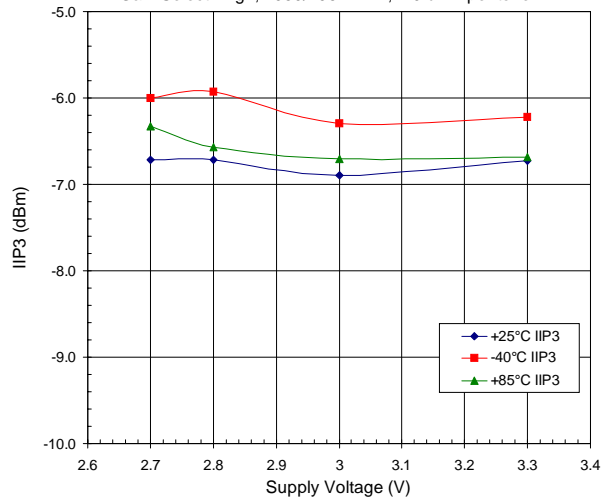

**Mixer2 Gain versus Frequency**

RX Mode,  $V_{CC}=2.8$  V, LO  $P_{IN}=-7$  dBm

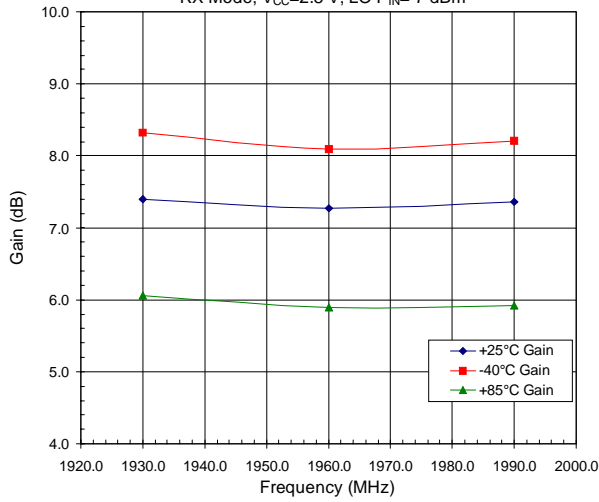

**Mixer2 Gain versus Supply Voltage**

RX Mode, 1960 MHz, LO  $P_{IN}=-7$  dBm

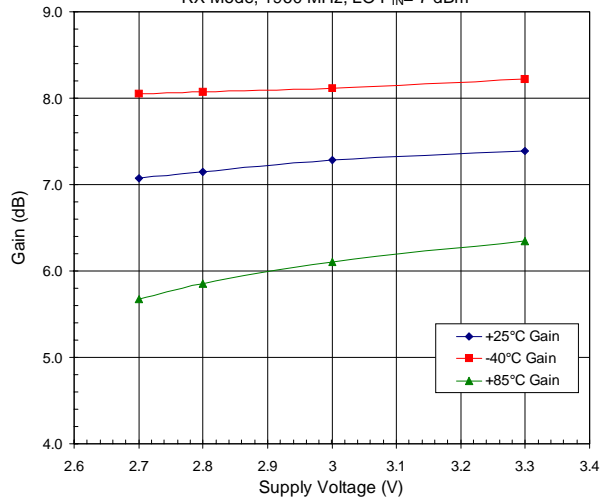

**Mixer2 SSB Noise Figure versus Frequency**

RX Mode,  $V_{CC}=2.8$  V, LO  $P_{IN}=-7$  dBm

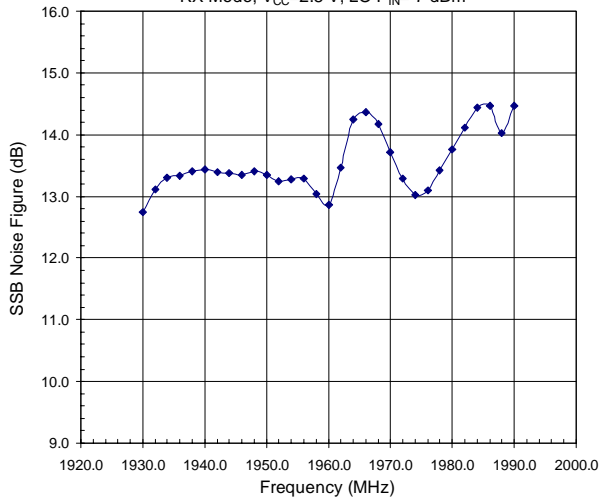

**Mixer2 SSB Noise Figure versus Supply Voltage**

RX Mode, 1960 MHz, LO  $P_{IN}=-7$  dBm

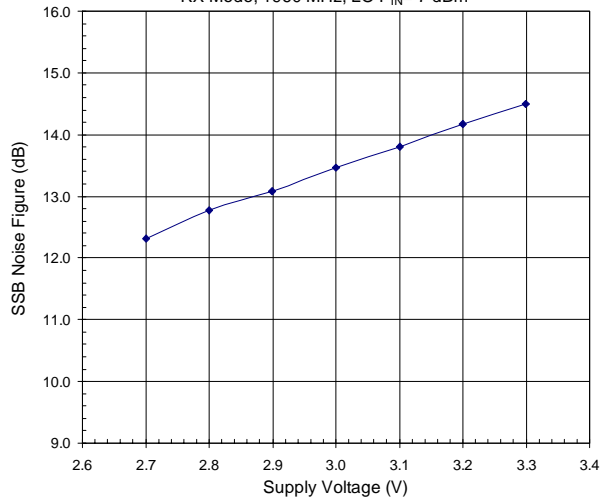

**Mixer2 Input IP3 versus Frequency**

RX Mode, -30 dBm per tone, 1 MHz Separation,  $V_{CC}=2.8$  V, LO  $P_{IN}=-7$  dBm

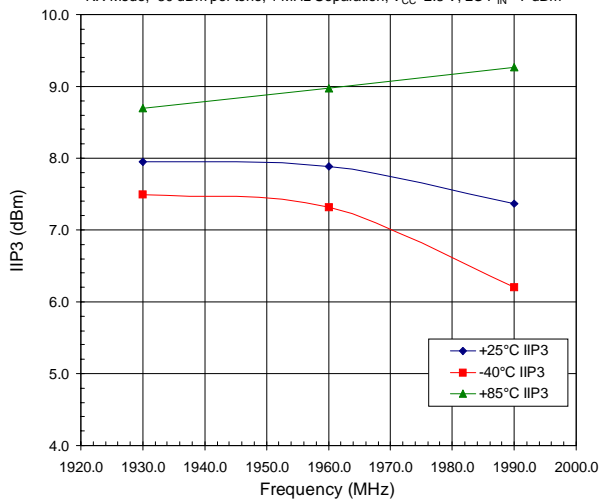

**Mixer2 Input IP3 versus Supply Voltage**

RX Mode, 1960/1961 MHz, -30 dBm per tone, LO  $P_{IN}=-7$  dBm

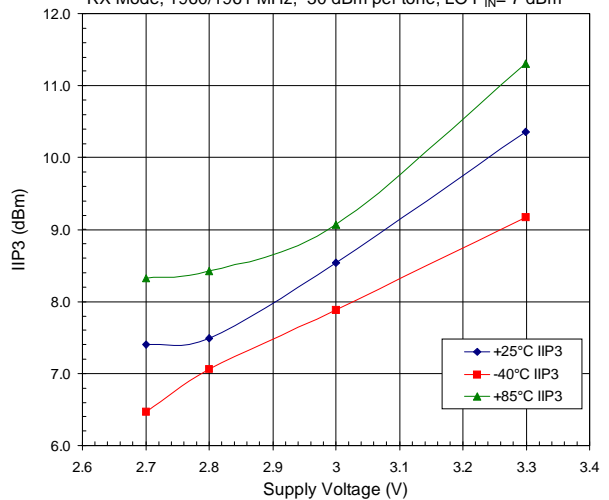

**Mixer1 versus LO Amplitude**

RX Mode, 882 MHz,  $V_{CC}=2.8$  V

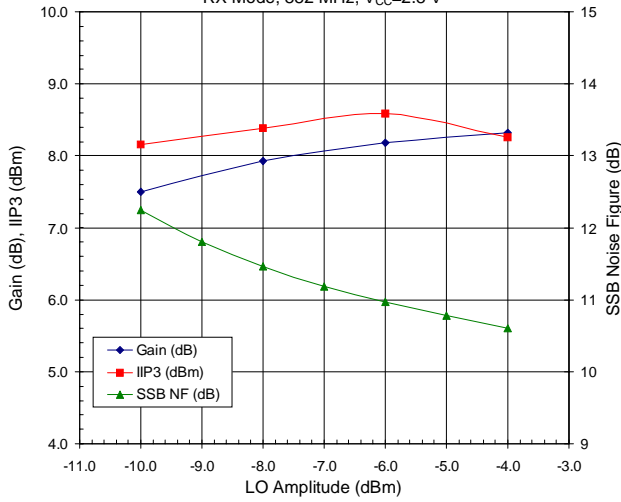

**Mixer2 versus LO Amplitude**

RX Mode, 1960 MHz,  $V_{CC}=2.8$  V

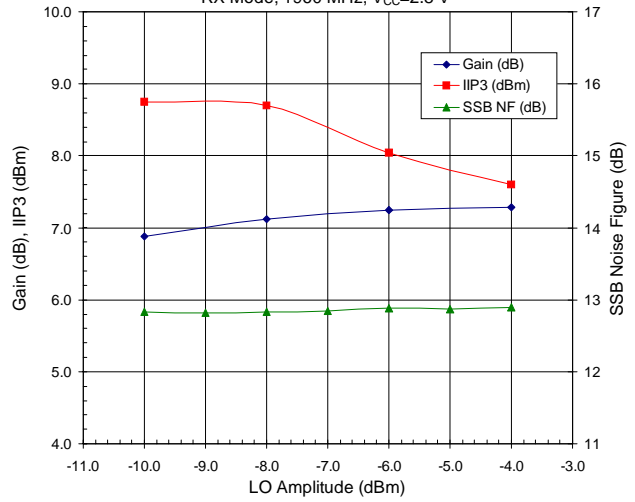

**LNA1 + Mixer1 Gain versus Frequency**

RX Mode, Gain Select= High,  $V_{CC}=2.8$  V, LO  $P_{IN}=-7$  dBm

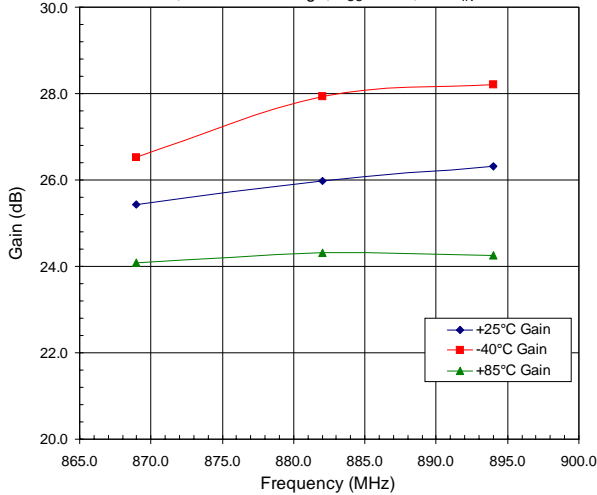

**LNA1+Mixer1 Gain versus Supply Voltage**

RX Mode, Gain Select=High, 882 MHz, LO  $P_{IN}=-7$  dBm

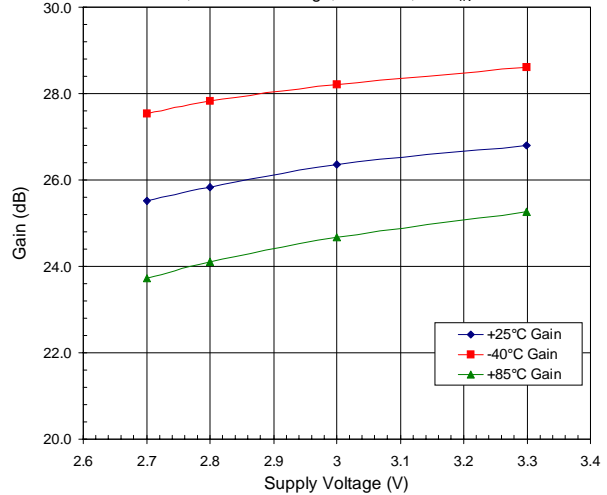

**LNA1 + Mixer1 Input IP3 versus Frequency**

RX Mode, Gain Select=High, 882/883 MHz, -40 dBm per tone,  $V_{CC}=2.8$  V, LO  $P_{IN}=-7$  dBm

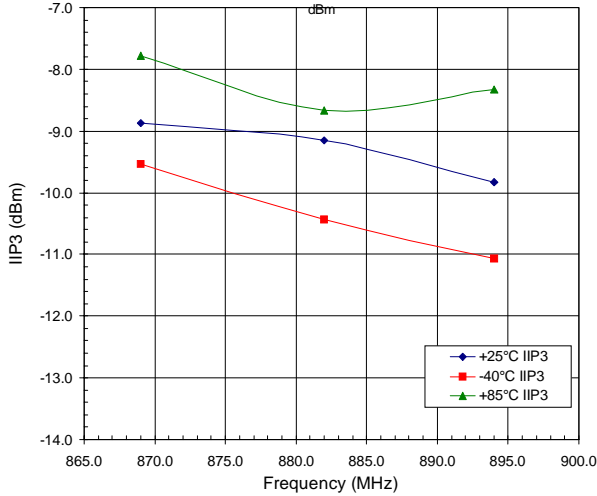

**LNA1 + Mixer1 SSB Noise Figure versus Frequency**

RX Mode, Gain Select=High,  $V_{CC}=2.8$  V, LO  $P_{IN}=-7$  dBm

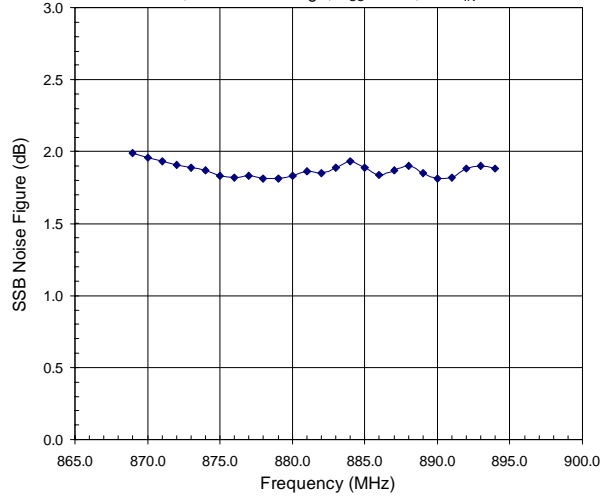



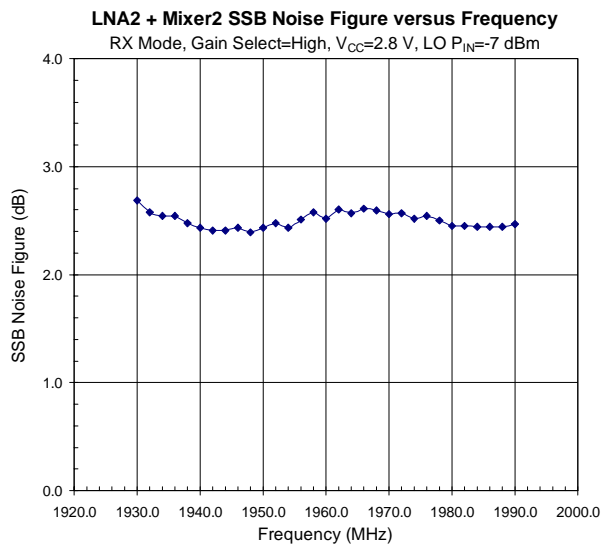
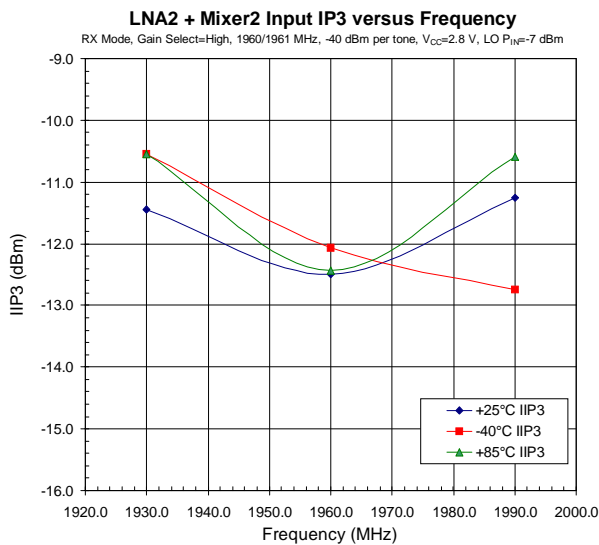
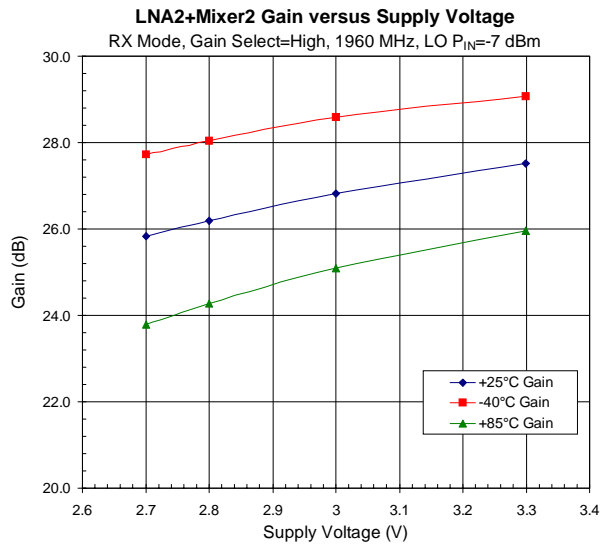
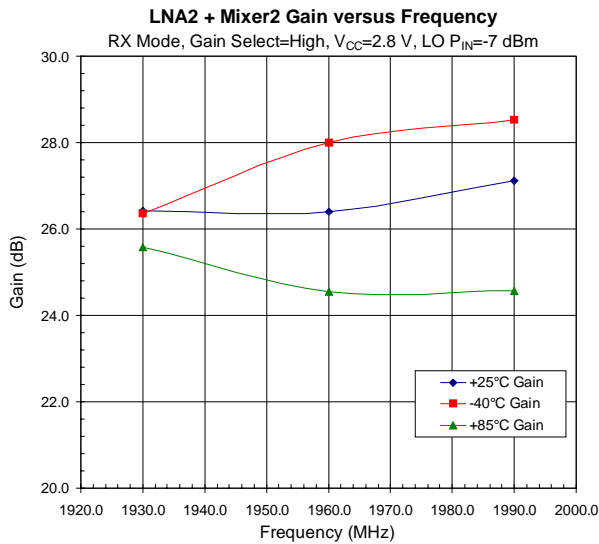
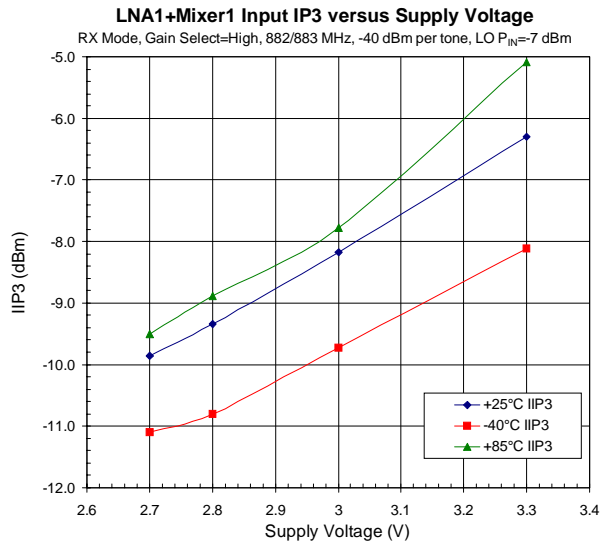
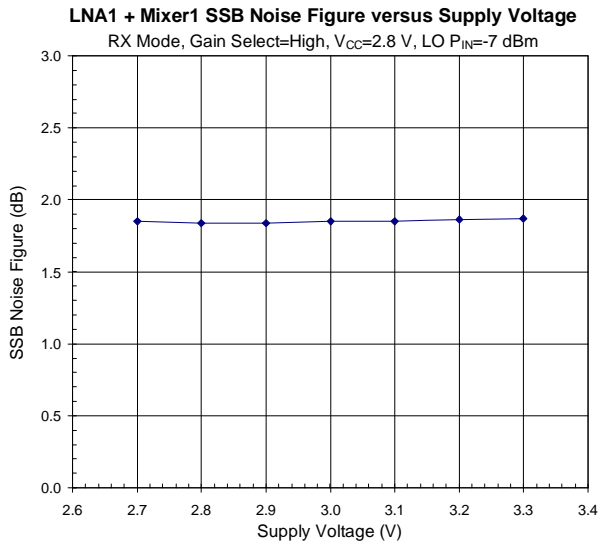

FRONT-ENDS

**LNA2 + Mixer2 SSB Noise Figure versus Supply Voltage**  
 RX Mode, Gain Select=High,  $V_{CC}=2.8$  V, LO  $P_{IN}=-7$  dBm

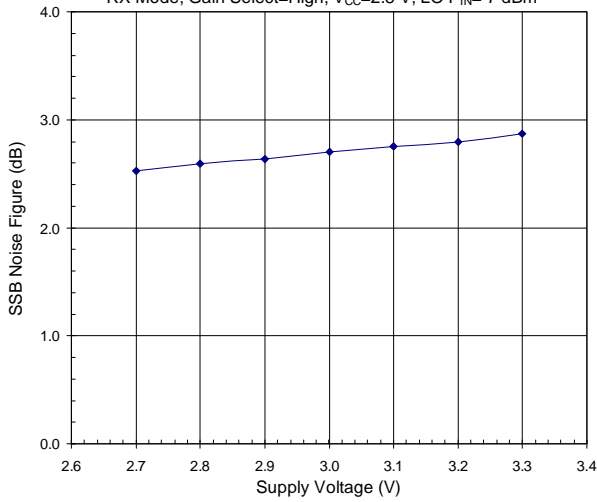

**LNA2+Mixer2 IIP3 versus Supply Voltage**

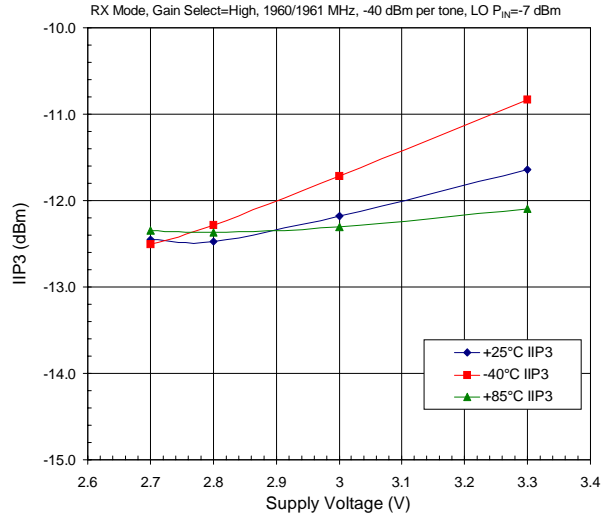

**LNA1+Mixer1 Current versus Supply Voltage**  
 RX Mode, Gain Select=High, 882 MHz, LO  $P_{IN}=-7$  dBm

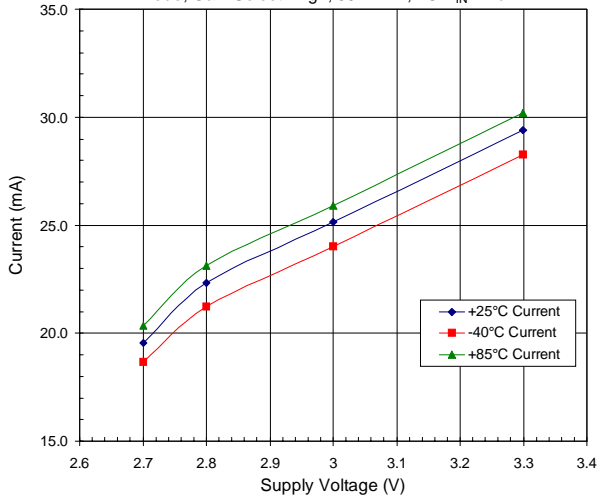

**LNA2+Mixer2 Current versus Supply Voltage**  
 RX Mode, Gain Select=High, 1960 MHz, LO  $P_{IN}=-7$  dBm

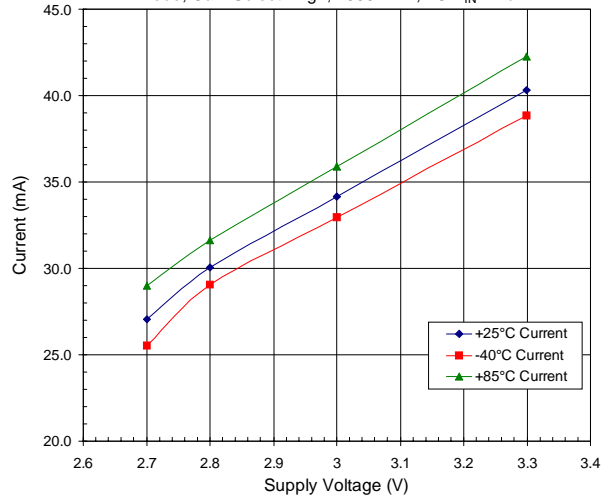

**LNA1 + Mixer1 versus LO Amplitude**  
 RX Mode, Gain Select=High, 882 MHz,  $V_{CC}=2.8$  V

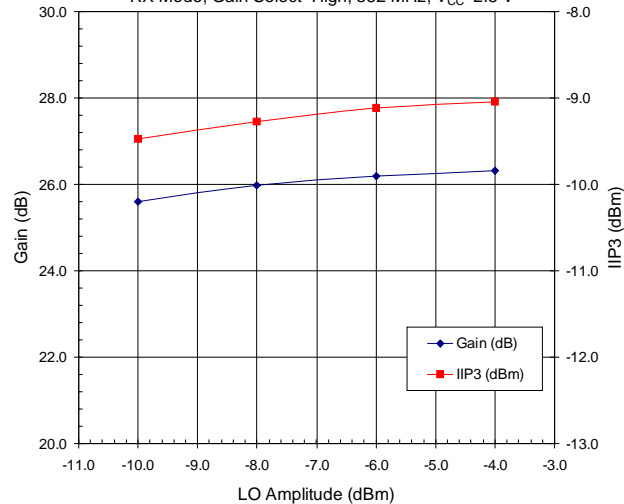

**LNA2 + Mixer2 versus LO Amplitude**  
 RX Mode, Gain Select=High, 1960 MHz,  $V_{CC}=2.8$  V

