

PC-16T1

The Photocoupler consists of a Gallium Arsenide Infrared Emitting Diode and a Silicon NPN Phototransistor per a channel.
 The PC-16T1 has one channel in a 4-pin package.

FEATURES

- Small Package Size
- Collector-Emitter Voltage : Min.35V
- Current Transfer Ratio : Min.50% (at IF=1mA, VCE=5V)
- Electrical Isolation Voltage : AC2500V_{rms}
- Creepage/Clearance between Input and Output : Min. 7.0mm
- UL Recognized File No. E107486

APPLICATIONS

- Interface between two circuits of different potential
- Vending Machine, Cordless Phone, Key Phone, Fax, Motor Control
- Programmable Logic Control
- Power Supply
- Computer Terminals

DIMENSION

(Unit : mm)

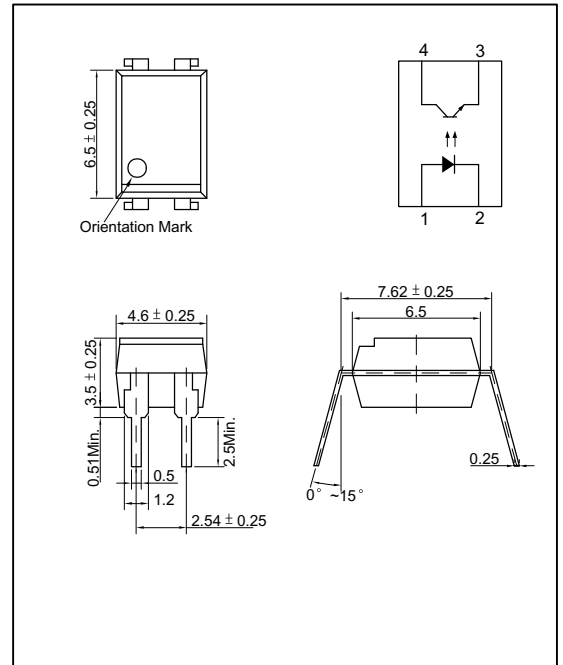

MAXIMUM RATINGS

(Ta=25°C)

Parameter		Symbol	Rating	Unit
Input	Forward Current	I _F	50	mA
	Reverse Voltage	V _R	5	V
	Peak Forward Current ^{*1}	I _{FP}	1	A
	Power Dissipation	P _D	70	mW
Output	Collector-Emitter Breakdown Voltage	BV _{CEO}	35	V
	Emitter-Collector Breakdown Voltage	BV _{ECO}	6	V
	Collector Current	I _C	50	mA
	Collector Power Dissipation	P _C	150	mW
Input to Output Isolation Voltage ^{*2}		V _{iso}	AC2500	V _{rms}
Storage Temperature		T _{stg}	-55~+125	°C
Operating Temperature		T _{opr}	-30~+100	°C
Lead Soldering Temperature ^{*3}		T _{sol}	260	°C
Total Power Dissipation		P _{tot}	200	mW

*1. Input current with 100µs pulse width, 1% duty cycle

*2. Measured at RH=40~60% for 1min

*3. 1/16 inch form case for 10sec

PC-16T1

ELECTRO-OPTICAL CHARACTERISTICS

(Ta=25°C , unless otherwise noted)

Parameter		Symbol	Condition	Min.	Typ.	Max.	Unit.
Input	Forward Voltage	V _F	I _F =10mA	-	1.15	1.30	V
	Reverse Current	I _R	V _R =5V	-	-	10	μA
	Capacitance	C _T	V=0, f=1MHz	-	30	-	pF
Output	Collector-Emitter Breakdown Voltage	BV _{CEO}	I _C =0.5mA	35	-	-	V
	Emitter-Collector Breakdown Voltage	BV _{ECO}	I _E =0.1mA	6	-	-	V
	Collector Dark Current	I _{CEO}	I _F =0, V _{CE} =24V	-	-	100	nA
	Capacitance	C _{CE}	V _{CE} =0, f=1MHz	-	10	-	pF
Coupled	Current Transfer Ratio ^{*4}	CTR	I _F =1mA, V _{CE} =5V	50	-	600	%
	Collector-Emitter Saturation Voltage	V _{CE(SAT)}	I _F =5mA, I _C =1mA	-	0.15	0.4	V
	Input-Output Capacitance	C _{IO}	V=0, f=1MHz	-	1	-	pF
	Input-Output Isolation Resistance	R _{IO}	RH=40~60%, V=500V	-	10 ¹¹	-	Ω
	Rise Time	t _r	V _{CE} =5V, R _L =100Ω I _C =2mA	-	4	-	μs
	Fall Time	t _f		-	4	-	μs

*4. CTR=(I_C/I_F) X 100 (%)

PC-16T1

Forward Current vs. Ambient Temperature

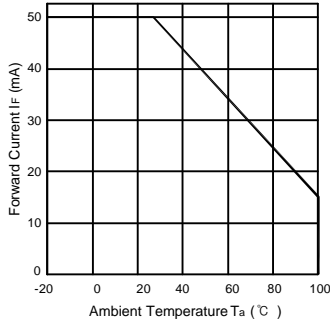

Collector Power Dissipation vs. Ambient Temperature

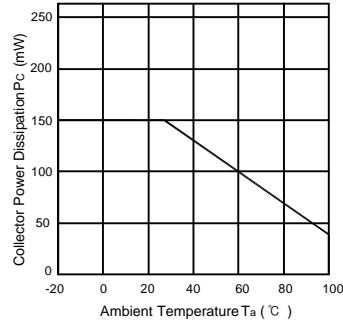

Forward Current vs. Forward Voltage

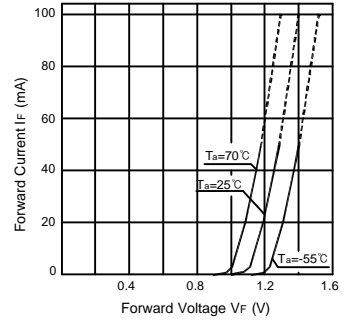

Collector Current vs. Collector-Emitter Voltage

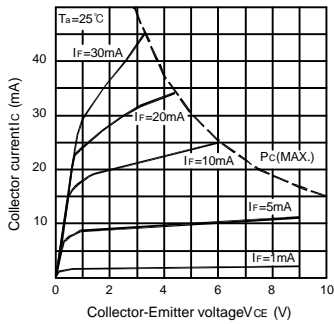

Dark Current vs. Ambient Temperature

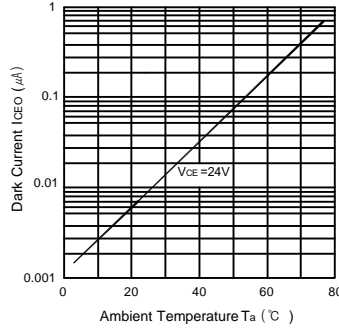

Collector Current vs. Ambient Temperature

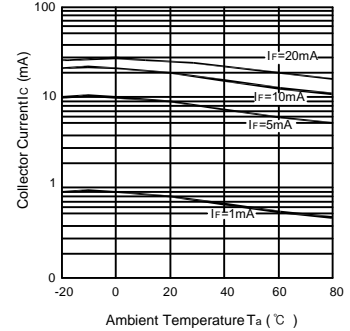

Response Time vs. Load Resistance

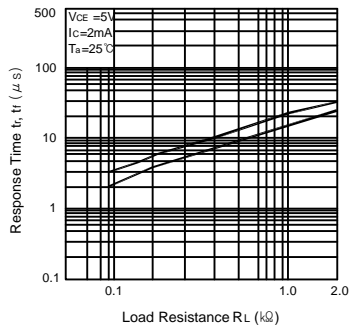

Collector Current vs. Forward Current

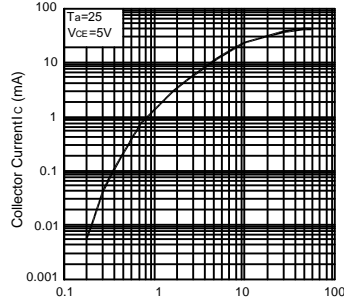

Switching Time Test Circuit

