

The RF Sub-Micron MOSFET Line
RF Power Field Effect Transistors
N-Channel Enhancement-Mode Lateral MOSFETs

MRF9030LR1
MRF9030LSR1

Designed for broadband commercial and industrial applications with frequencies up to 1.0 GHz. The high gain and broadband performance of these devices make them ideal for large-signal, common-source amplifier applications in 26 volt base station equipment.

945 MHz, 30 W, 26 V
LATERAL N-CHANNEL
BROADBAND
RF POWER MOSFETs

- Typical Two-Tone Performance at 945 MHz, 26 Volts
 Output Power — 30 Watts PEP
 Power Gain — 19 dB
 Efficiency — 41.5%
 IMD — -32.5 dBc
- Integrated ESD Protection
- Designed for Maximum Gain and Insertion Phase Flatness
- Capable of Handling 10:1 VSWR, @ 26 Vdc, 945 MHz, 30 Watts CW Output Power
- Excellent Thermal Stability
- Characterized with Series Equivalent Large-Signal Impedance Parameters
- In Tape and Reel. R1 Suffix = 500 Units per 32 mm, 13 inch Reel.
- Low Gold Plating Thickness on Leads. L Suffix Indicates 40μ" Nominal.

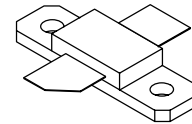

CASE 360B-05, STYLE 1
NI-360
MRF9030LR1

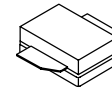

CASE 360C-05, STYLE 1
NI-360S
MRF9030LSR1

MAXIMUM RATINGS

Rating	Symbol	Value	Unit
Drain-Source Voltage	V_{DSS}	68	Vdc
Gate-Source Voltage	V_{GS}	- 0.5, + 15	Vdc
Total Device Dissipation @ $T_C = 25^\circ\text{C}$ Derate above 25°C	P_D	92 0.53 117 0.67	Watts W/°C
Storage Temperature Range	T_{stg}	- 65 to +150	°C
Operating Junction Temperature	T_J	200	°C

THERMAL CHARACTERISTICS

Characteristic	Symbol	Max	Unit
Thermal Resistance, Junction to Case	$R_{\theta JC}$	1.9 1.5	°C/W

ESD PROTECTION CHARACTERISTICS

Test Conditions	Class
Human Body Model	1 (Minimum)
Machine Model	M1 (Minimum)

NOTE - CAUTION - MOS devices are susceptible to damage from electrostatic charge. Reasonable precautions in handling and packaging MOS devices should be observed.

Freescale Semiconductor, Inc.

ELECTRICAL CHARACTERISTICS (T_C = 25°C unless otherwise noted)

Characteristic	Symbol	Min	Typ	Max	Unit
----------------	--------	-----	-----	-----	------

OFF CHARACTERISTICS

Zero Gate Voltage Drain Leakage Current (V _{DS} = 68 Vdc, V _{GS} = 0 Vdc)	I _{DSS}	—	—	10	μAdc
Zero Gate Voltage Drain Leakage Current (V _{DS} = 26 Vdc, V _{GS} = 0 Vdc)	I _{DSS}	—	—	1	μAdc
Gate-Source Leakage Current (V _{GS} = 5 Vdc, V _{DS} = 0 Vdc)	I _{GSS}	—	—	1	μAdc

ON CHARACTERISTICS

Gate Threshold Voltage (V _{DS} = 10 Vdc, I _D = 100 μAdc)	V _{GS(th)}	2	2.9	4	Vdc
Gate Quiescent Voltage (V _{DS} = 26 Vdc, I _D = 250 mAdc)	V _{GS(Q)}	—	3.8	—	Vdc
Drain-Source On-Voltage (V _{GS} = 10 Vdc, I _D = 0.7 Adc)	V _{DS(on)}	—	0.19	0.4	Vdc
Forward Transconductance (V _{DS} = 10 Vdc, I _D = 2 Adc)	g _{fs}	—	3	—	S

DYNAMIC CHARACTERISTICS

Input Capacitance (V _{DS} = 26 Vdc ± 30 mV(rms)ac @ 1 MHz, V _{GS} = 0 Vdc)	C _{iss}	—	49.5	—	pF
Output Capacitance (V _{DS} = 26 Vdc ± 30 mV(rms)ac @ 1 MHz, V _{GS} = 0 Vdc)	C _{oss}	—	26.5	—	pF
Reverse Transfer Capacitance (V _{DS} = 26 Vdc ± 30 mV(rms)ac @ 1 MHz, V _{GS} = 0 Vdc)	C _{rss}	—	1	—	pF

(continued)

Freescale Semiconductor, Inc.

ELECTRICAL CHARACTERISTICS — continued (T_C = 25°C unless otherwise noted)

Characteristic	Symbol	Min	Typ	Max	Unit
FUNCTIONAL TESTS (In Motorola Test Fixture, 50 ohm system)					
Two-Tone Common-Source Amplifier Power Gain (V _{DD} = 26 Vdc, P _{out} = 30 W PEP, I _{DQ} = 250 mA, f ₁ = 945.0 MHz, f ₂ = 945.1 MHz)	G _{ps}	18	19	—	dB
Two-Tone Drain Efficiency (V _{DD} = 26 Vdc, P _{out} = 30 W PEP, I _{DQ} = 250 mA, f ₁ = 945.0 MHz, f ₂ = 945.1 MHz)	η	37	41.5	—	%
3rd Order Intermodulation Distortion (V _{DD} = 26 Vdc, P _{out} = 30 W PEP, I _{DQ} = 250 mA, f ₁ = 945.0 MHz, f ₂ = 945.1 MHz)	IMD	—	-32.5	-28	dBc
Input Return Loss (V _{DD} = 26 Vdc, P _{out} = 30 W PEP, I _{DQ} = 250 mA, f ₁ = 945.0 MHz, f ₂ = 945.1 MHz)	IRL	—	-15.5	-9	dB
Two-Tone Common-Source Amplifier Power Gain (V _{DD} = 26 Vdc, P _{out} = 30 W PEP, I _{DQ} = 250 mA, f ₁ = 930.0 MHz, f ₂ = 930.1 MHz and f ₁ = 960.0 MHz, f ₂ = 960.1 MHz)	G _{ps}	—	19	—	dB
Two-Tone Drain Efficiency (V _{DD} = 26 Vdc, P _{out} = 30 W PEP, I _{DQ} = 250 mA, f ₁ = 930.0 MHz, f ₂ = 930.1 MHz and f ₁ = 960.0 MHz, f ₂ = 960.1 MHz)	η	—	41.5	—	%
3rd Order Intermodulation Distortion (V _{DD} = 26 Vdc, P _{out} = 30 W PEP, I _{DQ} = 250 mA, f ₁ = 930.0 MHz, f ₂ = 930.1 MHz and f ₁ = 960.0 MHz, f ₂ = 960.1 MHz)	IMD	—	-33	—	dBc
Input Return Loss (V _{DD} = 26 Vdc, P _{out} = 30 W PEP, I _{DQ} = 250 mA, f ₁ = 930.0 MHz, f ₂ = 930.1 MHz and f ₁ = 960.0 MHz, f ₂ = 960.1 MHz)	IRL	—	-14	—	dB
Power Output, 1 dB Compression Point (V _{DD} = 26 Vdc, P _{out} = 30 W CW, I _{DQ} = 250 mA, f ₁ = 945.0 MHz)	P _{1dB}	—	30	—	W
Common-Source Amplifier Power Gain (V _{DD} = 26 Vdc, P _{out} = 30 W CW, I _{DQ} = 250 mA, f ₁ = 945.0 MHz)	G _{ps}	—	19	—	dB
Drain Efficiency (V _{DD} = 26 Vdc, P _{out} = 30 W CW, I _{DQ} = 250 mA, f ₁ = 945.0 MHz)	η	—	60	—	%
Output Mismatch Stress (V _{DD} = 26 Vdc, P _{out} = 30 W CW, I _{DQ} = 250 mA, f = 945.0 MHz, VSWR = 10:1, All Phase Angles at Frequency of Tests)	Ψ	No Degradation In Output Power			

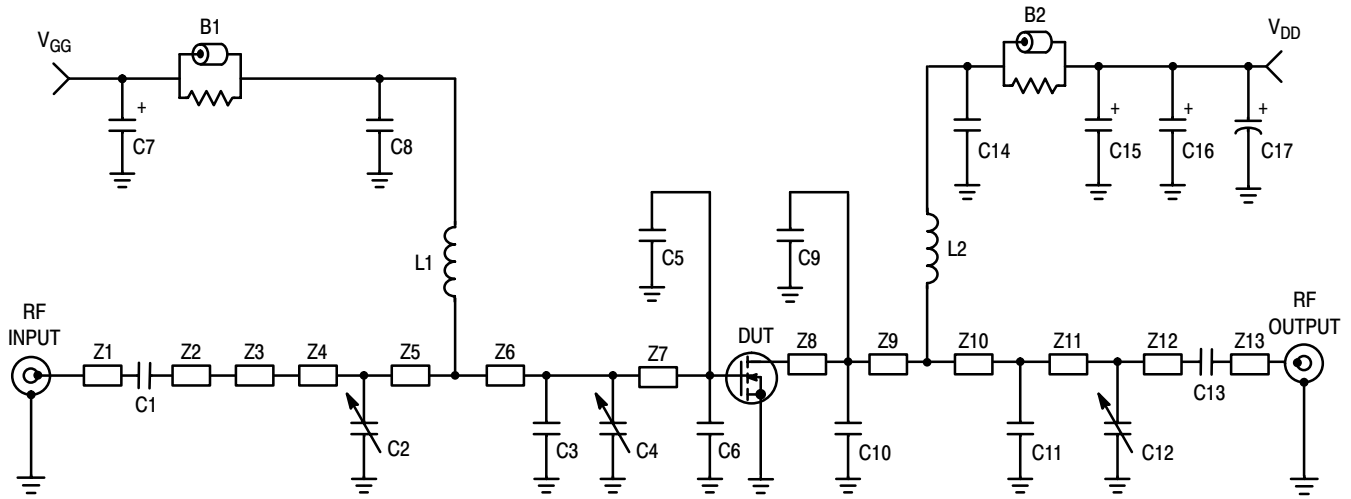

B1	Short Ferrite Bead	Z3	0.500" x 0.100" Microstrip
B2	Long Ferrite Bead	Z4	0.215" x 0.270" Microstrip
C1, C8, C13, C14	47 pF Chip Capacitors, B Case	Z5	0.315" x 0.270" Microstrip
C2, C4	0.8 pF to 8.0 pF Trim Capacitors	Z6	0.160" x 0.270" x 0.520", Taper
C3	3.9 pF Chip Capacitor, B Case	Z7	0.285" x 0.520" Microstrip
C5, C6	7.5 pF Chip Capacitors, B Case	Z8	0.140" x 0.270" Microstrip
C7, C15, C16	10 μ F, 35 V Tantalum Capacitors	Z9	0.450" x 0.270" Microstrip
C9, C10	10 pF Chip Capacitors, B Case	Z10	0.250" x 0.060" Microstrip
C11	9.1 pF Chip Capacitor, B Case	Z11	0.720" x 0.060" Microstrip
C12	0.6 pF to 4.5 pF Trim Capacitor	Z12	0.490" x 0.060" Microstrip
C17	220 μ F, 50 V Electrolytic Capacitor	Z13	0.290" x 0.060" Microstrip
L1, L2	12.5 nH Surface Mount Inductors	PCB	Taconic RF-35-0300, 30 mil, $\epsilon_r = 3.55$
Z1	0.260" x 0.060" Microstrip		
Z2	0.240" x 0.060" Microstrip		

Figure 1. 945 MHz Broadband Test Circuit Schematic

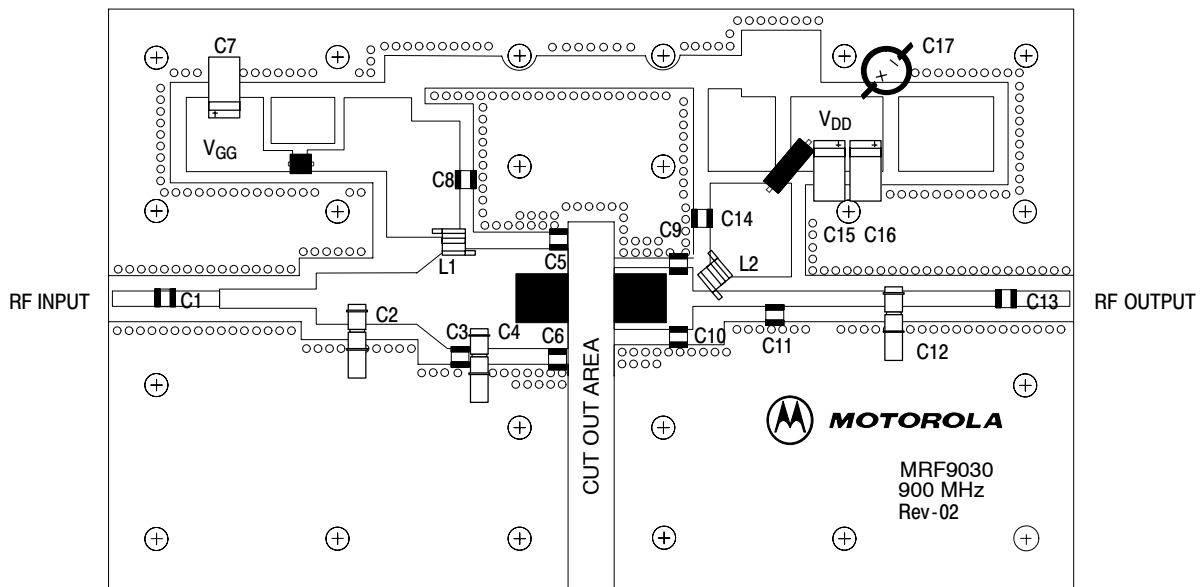

Figure 2. 945 MHz Broadband Test Circuit Component Layout

Freescale Semiconductor, Inc.

TYPICAL CHARACTERISTICS

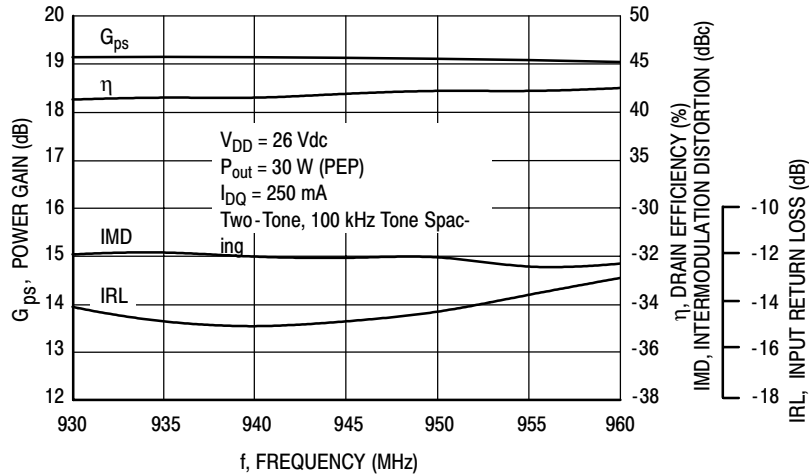

Figure 3. Class AB Broadband Circuit Performance

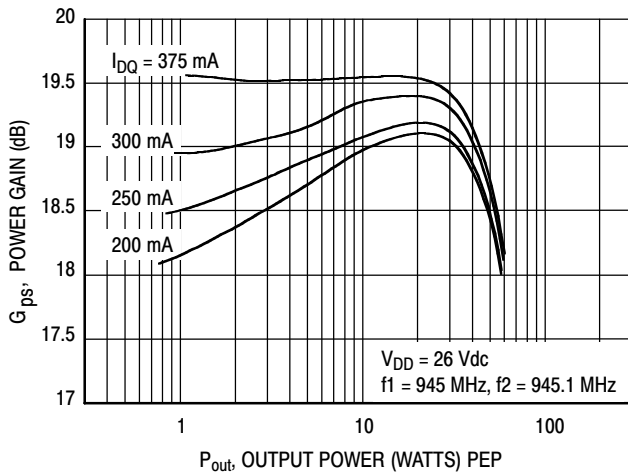

Figure 4. Power Gain versus Output Power

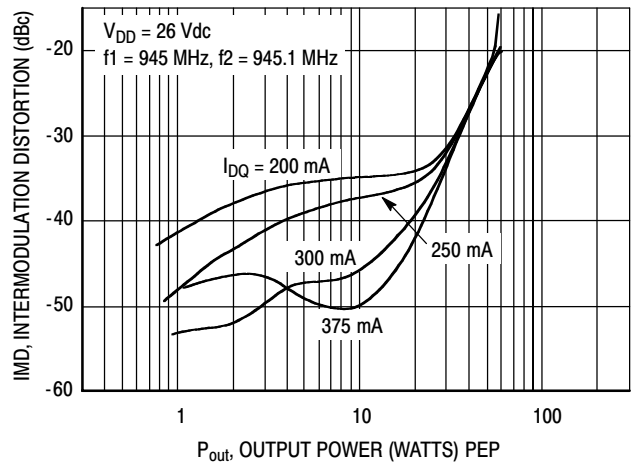

Figure 5. Intermodulation Distortion versus Output Power

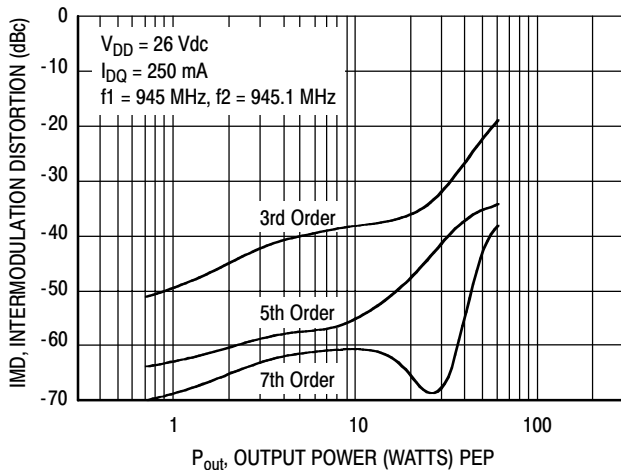

Figure 6. Intermodulation Distortion Products versus Output Power

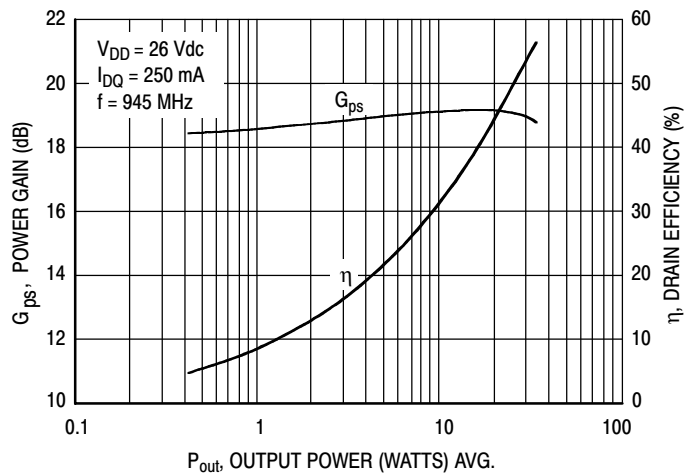

Figure 7. Power Gain and Efficiency versus Output Power

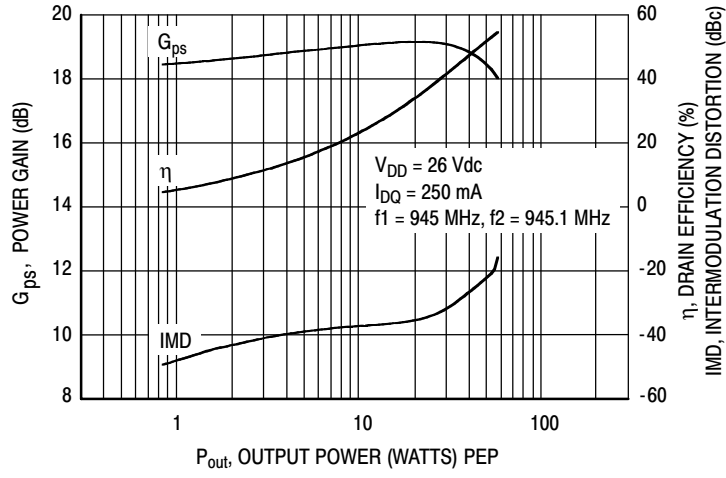
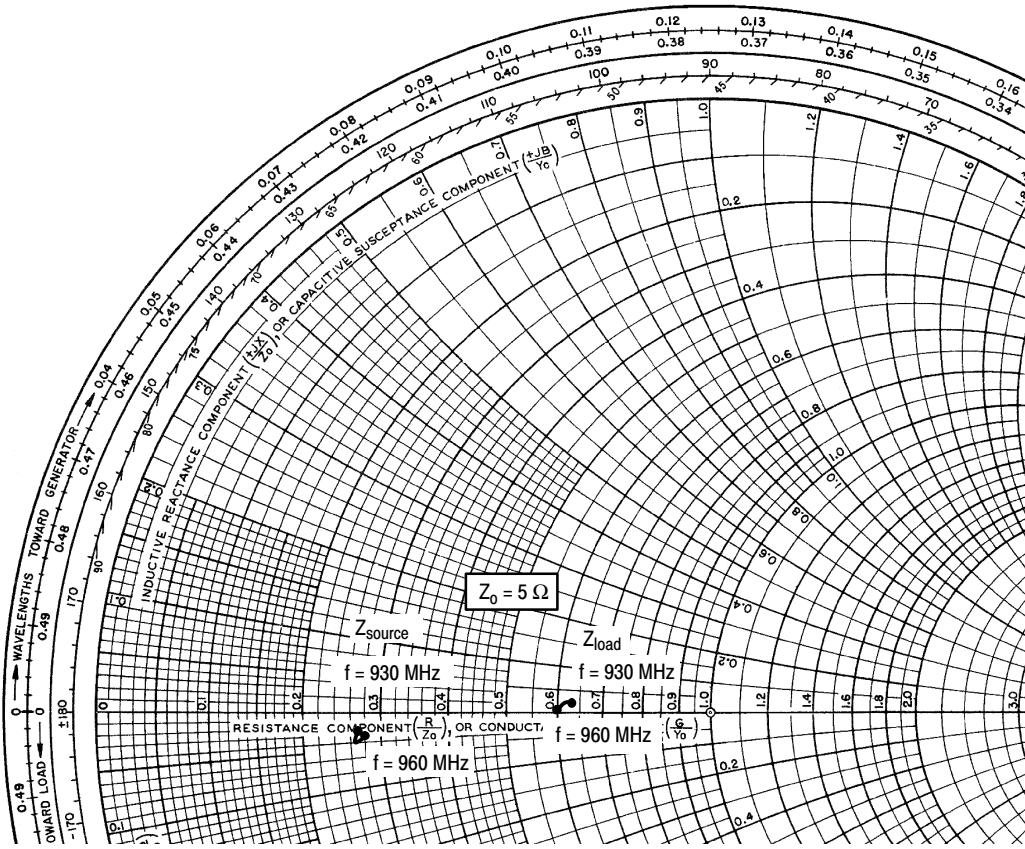

Figure 8. Power Gain, Efficiency and IMD versus Output Power



$V_{DD} = 26 \text{ V}$, $I_{DQ} = 250 \text{ mA}$, $P_{out} = 30 \text{ W PEP}$

f MHz	Z_{source} Ω	Z_{load} Ω
930	$1.34 - j0.1$	$3.175 + j0.09$
945	$1.36 - j0.2$	$3.1 + j0.08$
960	$1.4 - j0.14$	$3.0 + j0.05$

Z_{source} = Test circuit impedance as measured from gate to ground.

Z_{load} = Test circuit impedance as measured from drain to ground.

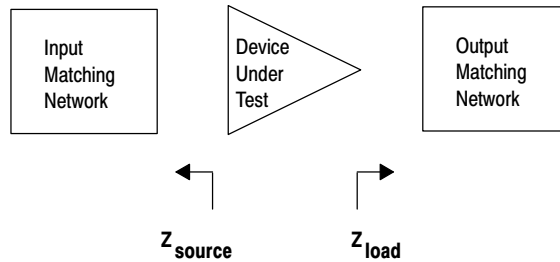

Figure 9. Series Equivalent Input and Output Impedance

NOTES

NOTES

NOTES

Freescale Semiconductor, Inc.

PACKAGE DIMENSIONS

NOTES:

1. INTERPRET DIMENSIONS AND TOLERANCES PER ASME Y14.5M-1994.
2. CONTROLLING DIMENSION: INCH.
3. DIMENSION H IS MEASURED 0.030 (0.762) AWAY FROM PACKAGE BODY.

DIM	INCHES		MILLIMETERS	
	MIN	MAX	MIN	MAX
A	0.795	0.805	20.19	20.45
B	0.225	0.235	5.72	5.97
C	0.125	0.175	3.18	4.45
D	0.210	0.220	5.33	5.59
E	0.055	0.065	1.40	1.65
F	0.004	0.006	0.10	0.15
G	0.562 BSC		14.28 BSC	
H	0.077	0.087	1.96	2.21
K	0.220	0.250	5.59	6.35
M	0.355	0.365	9.02	9.27
N	0.357	0.363	9.07	9.22
Q	0.125	0.135	3.18	3.43
R	0.227	0.233	5.77	5.92
S	0.225	0.235	5.72	5.97
aaa	0.005 REF		0.13 REF	
bbb	0.010 REF		0.25 REF	
ccc	0.015 REF		0.38 REF	

STYLE 1:
 PIN 1. DRAIN
 2. GATE
 3. SOURCE

**CASE 360B-05
 ISSUE F
 NI-360
 MRF9030LR1**

NOTES:

1. INTERPRET DIMENSIONS AND TOLERANCES PER ASME Y14.5M-1994.
2. CONTROLLING DIMENSION: INCH.
3. DIMENSION H IS MEASURED 0.030 (0.762) AWAY FROM PACKAGE BODY.

DIM	INCHES		MILLIMETERS	
	MIN	MAX	MIN	MAX
A	0.375	0.385	9.53	9.78
B	0.225	0.235	5.72	5.97
C	0.105	0.155	2.67	3.94
D	0.210	0.220	5.33	5.59
E	0.035	0.045	0.89	1.14
F	0.004	0.006	0.10	0.15
H	0.057	0.067	1.45	1.70
K	0.085	0.115	2.16	2.92
M	0.355	0.365	9.02	9.27
N	0.357	0.363	9.07	9.22
R	0.227	0.23	5.77	5.92
S	0.225	0.235	5.72	5.97
aaa	0.005 REF		0.13 REF	
bbb	0.010 REF		0.25 REF	
ccc	0.015 REF		0.38 REF	

STYLE 1:
 PIN 1. DRAIN
 2. GATE
 3. SOURCE

**CASE 360C-05
 ISSUE D
 NI-360S
 MRF9030LSR1**

Information in this document is provided solely to enable system and software implementers to use Motorola products. There are no express or implied copyright licenses granted hereunder to design or fabricate any integrated circuits or integrated circuits based on the information in this document.

Motorola reserves the right to make changes without further notice to any products herein. Motorola makes no warranty, representation or guarantee regarding the suitability of its products for any particular purpose, nor does Motorola assume any liability arising out of the application or use of any product or circuit, and specifically disclaims any and all liability, including without limitation consequential or incidental damages. "Typical" parameters that may be provided in Motorola data sheets and/or specifications can and do vary in different applications and actual performance may vary over time. All operating parameters, including "Typicals", must be validated for each customer application by customer's technical experts. Motorola does not convey any license under its patent rights nor the rights of others. Motorola products are not designed, intended, or authorized for use as components in systems intended for surgical implant into the body, or other applications intended to support or sustain life, or for any other application in which the failure of the Motorola product could create a situation where personal injury or death may occur. Should Buyer purchase or use Motorola products for any such unintended or unauthorized application, Buyer shall indemnify and hold Motorola and its officers, employees, subsidiaries, affiliates, and distributors harmless against all claims, costs, damages, and expenses, and reasonable attorney fees arising out of, directly or indirectly, any claim of personal injury or death associated with such unintended or unauthorized use, even if such claim alleges that Motorola was negligent regarding the design or manufacture of the part.

MOTOROLA and the Stylized M Logo are registered in the US Patent and Trademark Office. All other product or service names are the property of their respective owners. Motorola, Inc. is an Equal Opportunity/Affirmative Action Employer.

© Motorola Inc. 2003

HOW TO REACH US:

USA/EUROPE/LOCATIONS NOT LISTED:
Motorola Literature Distribution
P.O. Box 5405, Denver, Colorado 80217
1-800-521-6274 or 480-768-2130

JAPAN: Motorola Japan Ltd.; SPS, Technical Information Center,
3-20-1, Minami-Azabu, Minato-ku, Tokyo 106-8573, Japan
81-3-3440-3569

ASIA/PACIFIC: Motorola Semiconductors H.K. Ltd.; Silicon Harbour Centre,
2 Dai King Street, Tai Po Industrial Estate, Tai Po, N.T., Hong Kong
852-26668334

HOME PAGE: <http://motorola.com/semiconductors>



◇ **For More Information On This Product,
Go to: www.freescale.com**

MRF9030/D